

# Wandsystem Schüco Kreativio

## Schüco Kreativio wall system

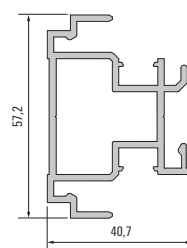

Nischen- und Wandsysteme  
Midway and wall systems

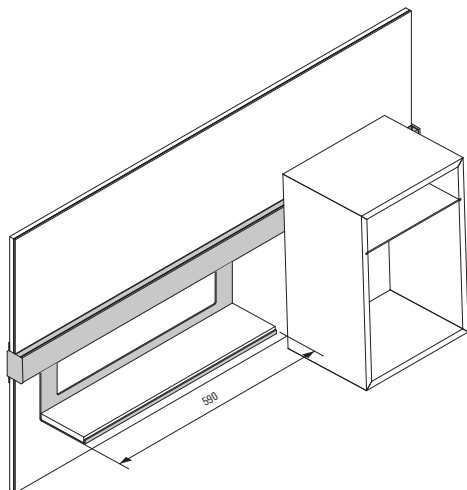

Grundträger  
928 160  
Base support  
928 160

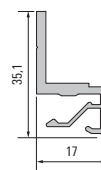

Panelträger  
928 161  
Panel support  
928 161

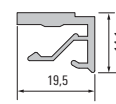

Nutabdeckung  
928 162  
Cover strip  
928 162

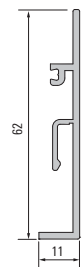

Abdeck- und Trägerleiste  
928 163  
Cover and support plate  
928 163



### Endlos kreativ.

Den individuellen Gestaltungsmöglichkeiten setzt das Wandsystem Kreativo keine Grenzen. Optisch eine Bereicherung für die Küche, den Wohn- und Arbeitsbereich. Gleichzeitig praktisch – es bietet viel Stauraum durch vielfältiges Zubehör. Es kann Räume verbinden oder Räume trennen. Ein echter Alleskönner, der sich mit einem durchdachten Konzept der Einzelemente beliebig horizontal oder vertikal erweitern lässt. Eine harmonische Beleuchtung ist optional möglich.

### Endlessly creative.

The Kreativo wall system places no limits on individual design possibilities. It visually enhances the kitchen, living area and workspace. It is also practical, offering plenty of storage space by means of versatile accessories. It can connect or divide spaces. A real all-rounder which can be extended horizontally or vertically as required by means of a sophisticated concept for the individual units. Harmonious lighting is also an option.

Vorteile	Benefits
<ul style="list-style-type: none"> <li>Offene Darstellung</li> <li>Hohe Flexibilität</li> <li>Optionale Beleuchtung möglich</li> </ul>	<ul style="list-style-type: none"> <li>Open representation</li> <li>High level of flexibility</li> <li>Optional lighting possible</li> </ul>

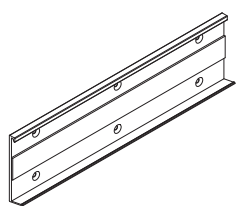

Montageleiste  
928 165.70.90  
250 mm  
Assembly rail  
928 165.70.90  
250 mm

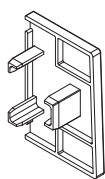

Endkappe  
553 847.66 links  
553 857.66 rechts  
End cap  
553 847.66 left  
553 857.66 right



Streulinse opal  
650 112  
Opal dispersing  
lens  
650 112

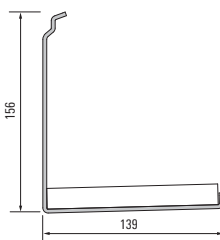

Regalboden  
928 431  
Shelf base  
928 431

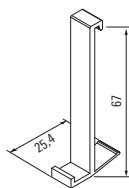

Haken  
928 164  
Hook  
928 164

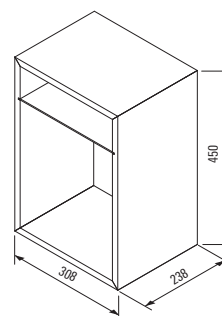

Box, offen  
928 411  
Box, open  
928 411

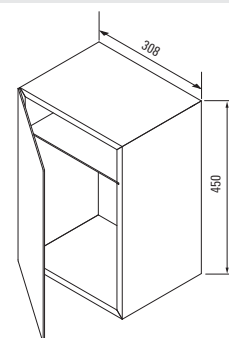

Box mit Tür  
928 432  
Box with door  
928 432