

Griffmulden Flush pull grips

Griffsysteme
Handle systems



Griffmulden folgen dem minimalistischen Wohnstil, was die Optik angeht. Die komplexe Technik bleibt im Verborgenen und beweist sich bei der täglichen Nutzung mit perfekter Ergonomie, höchster Stabilität und Flexibilität.

The look of the flush pull grips is in keeping with the minimalist interior design. The complex technology remains concealed, but proves itself during daily use through its perfect ergonomics, maximum stability and high flexibility.

Horizontale Ausrichtung Horizontal orientation

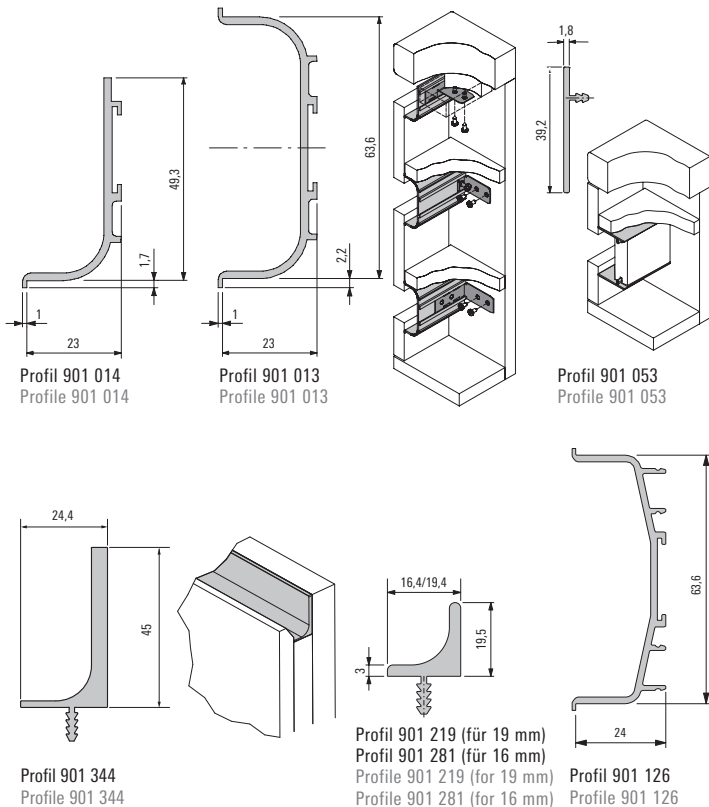

Vertikale Ausrichtung Vertical orientation

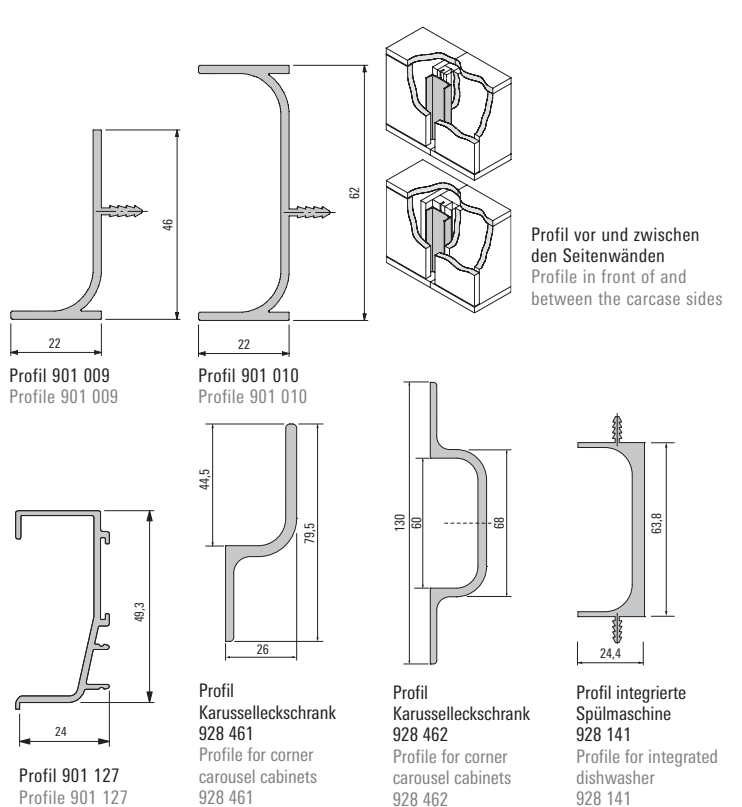





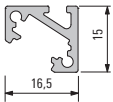
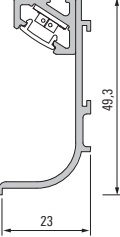
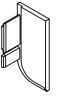
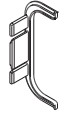
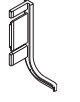
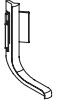
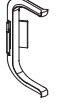
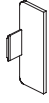

Für Karusselleckschränke und für Fronten integrierter Spülmaschinen sind spezielle Griffmuldenprofile erhältlich. Griffmulden können horizontal und vertikal angebracht werden. Auch die Ausstattung mit zusätzlicher LED-Beleuchtung ist möglich.

Special flush pull grip profiles are available for corner carousel cabinets and for the cabinet fronts of integrated dishwashers. Flush pull grips can be installed horizontally and vertically. Additional LED lighting can also be fitted.

Vorteile	Benefits
<ul style="list-style-type: none"> ▪ Komplettes Zubehör in hochwertiger, lackierter Ausführung ▪ Profile für Karusselleckschrank und integrierter Spülmaschine erhältlich ▪ Endkappen sowie Innen- und Außenecken erhältlich ▪ Eckwinkel für 135°-Lösungen ▪ LED-Lichtleiste möglich ▪ Integrierter Kabelkanal 	<ul style="list-style-type: none"> ▪ Complete accessories in high quality, lacquered finish ▪ Profiles for the corner carousel cabinet and integrated dishwasher are available ▪ End caps and inside and outside corners available ▪ Corner angle for 135° solutions ▪ LED light strip option ▪ Integrated cable channel

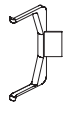
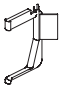
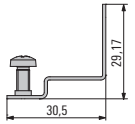
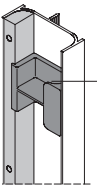
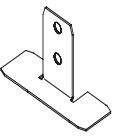
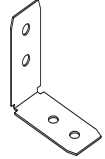
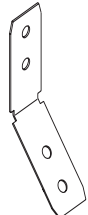
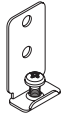
 <p>Streuscheibe opal 650 112 Opal dispersing lens 650 112</p>	 <p>Beleuchtungsprofil 985 064 Lighting profile 985 064</p>	 <p>Endkappe für 901 014 bündig 566 447* End cap for 901 014 flush 566 447*</p>	 <p>Endkappe für 901 013 überdeckend 566 607 End cap for 901 013 overlapping 566 607</p>	 <p>Endkappe für 901 014 überdeckend 566 617* End cap for 901 014 overlapping 566 617*</p>	 <p>Endkappe für 901 013 bündig 566 477 End cap for 901 013 flush 566 477</p>	<p>*linke und rechte Ausführung vorhanden *Left hand and right hand design available</p>	
 <p>Ecken für 901 014 innen 566 587 außen 566 517 Corners for 901 014 inside 566 587 outside 566 517</p>	 <p>Ecken für 901 013 innen 566 597 außen 566 527 Corners for 901 013 inside 566 597 outside 566 527</p>	 <p>Endkappe für 901 126 566 927.01 End cap for 901 126 566 927.01</p>	 <p>Endkappe für 901 127 rechts 566 737.01 links 566 747.01 End cap for 901 127 right 566 737.01 left 566 747.01</p>	 <p>Endkappe für 901 126 überdeckend 566 687 End cap 901 126 overlapping 566 687</p>	 <p>Endkappe für 901 127 rechts 566 637.01 links 566 637.02 End cap for 901 127 right 566 637.01 left 566 637.02</p>	 <p>Ecken für 901 126 innen 566 757.01 außen 566 767.01 Corners for 901 126 inside 566 757.01 outside 566 767.01</p>	 <p>Ecken für 901 127 innen 566 727.01 außen 566 717.01 Corners for 901 127 inside 566 727.01 outside 566 717.01</p>
 <p>Befestigungslasche 550 622 Fixing lug 550 622</p>	 <p>Montagehilfe Installation aid Füllprofil für E-Gerätebefestigung 600 oder 1150 mm, 901 316 Filler profile for mounting electrical appliances, 600 or 1150 mm, 901 316</p>	 <p>Befestigungswinkel 550 402 Fixing bracket 550 402</p>	 <p>Befestigungswinkel 550 512 Fixing bracket 550 512</p>	 <p>Eckwinkel 550 511 (135°) Corner angle 550 511 (135°)</p>	 <p>Befestigungslasche 551 544.30 Fixing lug 551 544.30</p>		