

Schüco Interior Smartcube shelving system

Much more than just a matter of form



SCHÜCO

Schüco Interior Smartcube shelving system

Enquiry Order

Company address (stamp)

Date Signature

Consignment: _____

Contact: _____

Requested delivery date: _____

Total number of pages sent: _____

Information:

Consent to your data being transferred to third parties
By sending this enquiry form, you consent to the data you entered in the contact form being forwarded to partners that can make your building plans a reality. Other privacy notices, particularly those on the processing of your personal data, the selection of potential partners for you, and your rights of access, rectification, deletion, restriction of processing, objection and appeal can be found at www.schueco.com/gdpr.

Shelf dimensions: (enter dimensions in mm)

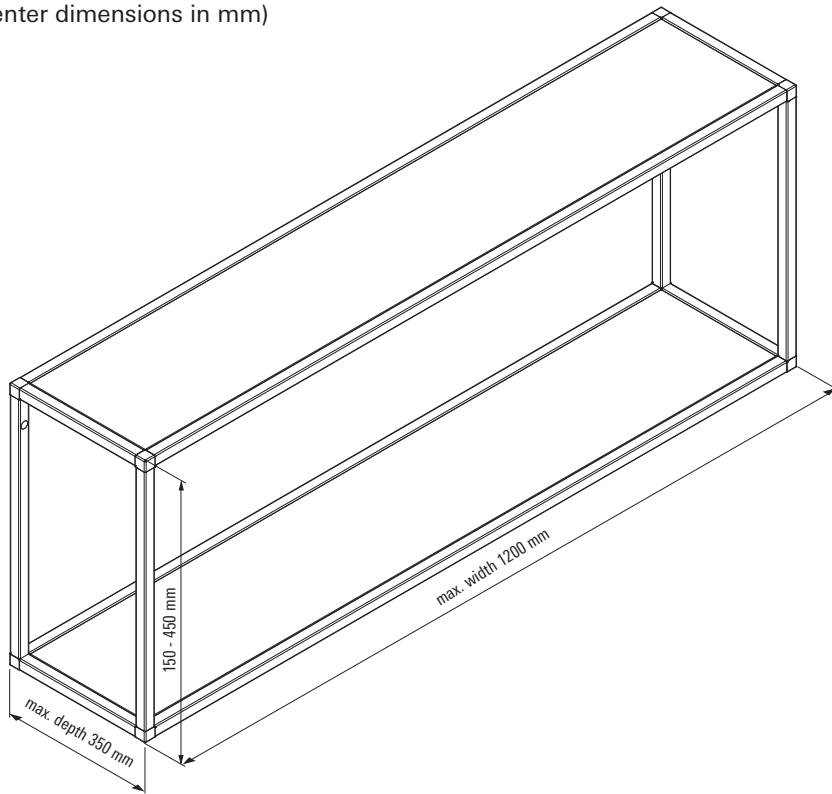

Length: mm Width: mm Depth: mm Smartcube quantity:

**Other dimensions and options possible on request.
Sketch your Schüco Interior Smartcube shelving system here:**

Profiles for Smartcube

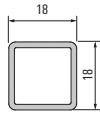

Strut
100008606
E6/stainless steel
5000 mm
100008606
E6/C35 black
5000 mm

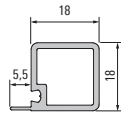

Strut with support
100008593
E6/stainless steel
5000 mm
100008590
E6/C35 black
5000 mm

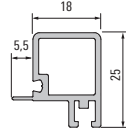

Strut
Sliding door, top
100008627
E6/C35 black
5000 mm

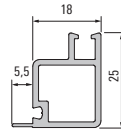

Strut
Sliding door, bottom
100008632
E6/C35 black
5000 mm

Corner joints

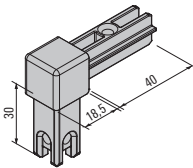

Corner joints 2 S
100003040
E6/stainless steel
100003039
E6/C35 black

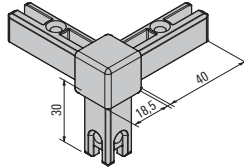

Corner joints 3 S
100003050
E6/stainless steel
100003049
E6/C35 black

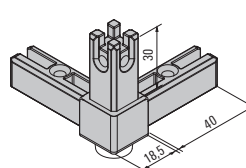

Corner joints 3 S including adjustable foot
100003070
E6/stainless steel
100003069
E6/C35 black

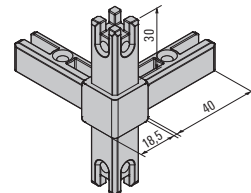

Corner joints 4 S
100003056
E6/stainless steel
100003055
E6/C35 black

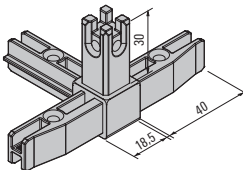

Corner joints 4 S H
100003062
E6/stainless steel
100003061
E6/C35 black

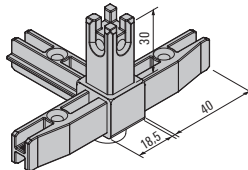

Corner joints 4 S H including adjustable foot
100003073
E6/stainless steel
100003072
E6/C35 black

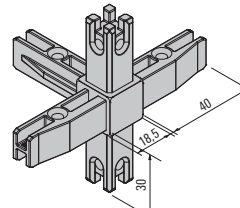

Corner joints 5 S
100003067
E6/stainless steel
100003066
E6/C35 black

Fittings set for Smartcube with sliding door

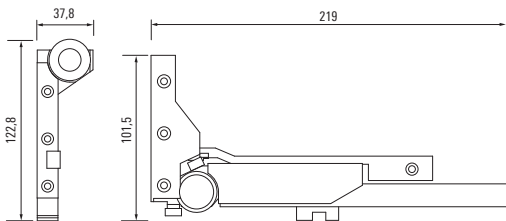

Slide Line M, fittings set damped
100002695

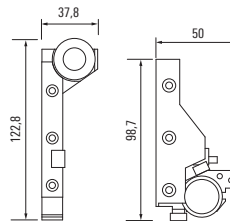

Slide Line M, fittings set not damped
100002692

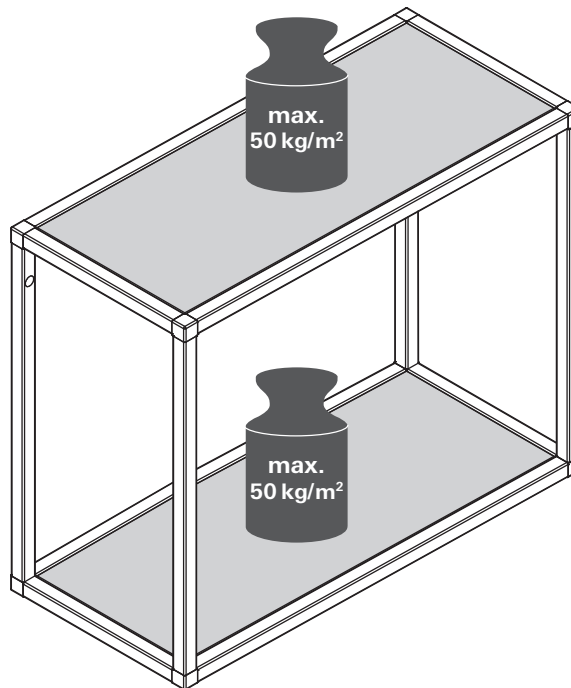

The system limits are described in the **installation instructions, Art. No. 100002252**.

The load capacity of the system was determined based on tests carried out within the framework of the applicable regulations and standards from the furniture and kitchen industry. It requires compliance with all the assembly steps described in detail. Deviations from the implemented specifications have an impact on the stability of the shelving system. Exceeding the system limits is not covered by our tests and is your responsibility to validate. We will gladly provide you with the test results of the system we have developed for your analysis upon request.

Please be sure to note: The supplied fixing (anchor) is only suitable for concrete walls and solid building materials (for example, sand-lime brick). The installation materials must be checked by the installer for their suitability at the intended installation location.