

Aluminium furniture systems



IDEAS BRING ROOMS TO LIFE

BE BOLD! Combinations that take your fancy · **THAT'S SMART**

Multifunctional shelving systems · **PLEASING TO THE TOUCH** Handle systems for every style





Ideas bring rooms to life.

Our lifestyles are changing. Today's lifestyles are characterised by flexibility, different ways of thinking, playing with new ideas, and spontaneity. This is accompanied by the awareness of true values such as quality, sustainability and focusing on the essentials.

Our living spaces are changing. In the mornings, it's a place to work; at lunch, it's a place to eat. Today a living room, tomorrow a home office. The kitchen has become the centre point for our daily lives, while even the bathroom is taking on a new importance, becoming a place to relax.

Our working environments are changing. Coworking spaces encourage teamwork and wellbeing at work. Sofas and cafeterias are making their way into offices.

All these changes are setting new benchmarks for furniture – the more flexible, the better. With its endless application and combination options, Schüco Openstyle, for example, focuses on these new values of transparency, openness and spontaneity. Then there's Schüco Smartcube, a truly unique shelving system in terms of flexibility. The product concept is both simple and complex, as are the stand systems which bear the weight of every table and piece of furniture. Be inspired by the countless possibilities for designing your individual space!

Your Schüco team

Contents

Room design system

6

Schüco Openstyle room design system

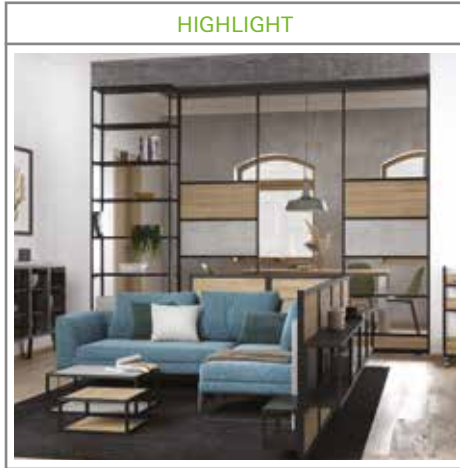

Sliding door system

12

MST sliding door system

14

MST handle profiles, frame profiles and guide tracks

16

MST accessories

16

MST floor tracks



Shelf systems

18

Schüco Smartcube shelving system

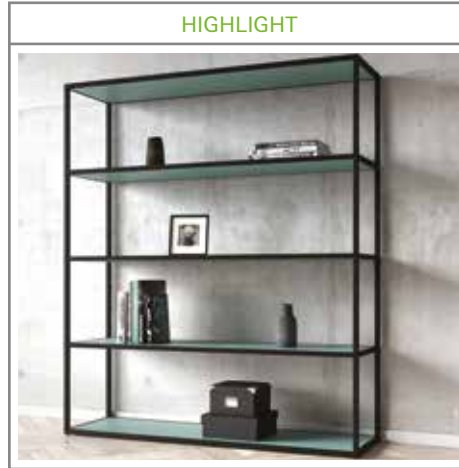

22

Schüco Smartframe shelving system

24

Schüco Mandeo shelving system

26

Schüco Ilumacube shelving system



Stand systems

28

Schüco Cone stand system

30

Schüco Frame stand system

32

Schüco Stair furniture leg

32

Plinth system

Handle systems

34

Schüco Divaro design cover



36

Handlebars



40
Concealed handlebars

40
Handle recess

42
Recessed handles



Frame systems

44
Glass frame systems



46
Glass frame profiles – bonded panes

46
Edge and front frame profiles

Midway and wall systems

48
Schüco Kreativo wall system

50
Midway system 16

52
Midway system 4-18

52
Panel system

54
Schüco Groove hanging rail

54
Schüco Groove wall attachment profile

56
Accessories for midway and wall systems



System components

58
Schüco Spaceline drawer organiser



60
Schüco Tara storage recess



62
Lighting profile

62
CD and DVD rack

64
Connecting profiles for worktops

64
Carcase corner cleat profiles

66
Ventilation grille

66
Roller shutter systems

Schüco Openstyle room design system

The new open-plan



Our living spaces are demanding more and more flexibility and multifunctionality. Living spaces grow together, merge into one, while walls disappear or dissolve into glass areas. With its light, slender architecture, Schüco Openstyle offers a range of options for the flexible design of open-plan spaces. Timeless design and high stability connect and separate living areas.

Thorsten Rosenstengel, byform produktdesign





What does inspiration mean?

Something new, unusual or creative. Focusing on the essentials. Bringing form and function together in harmony. Schüco Openstyle is the perfect product for creative, individual room design. The system is flexible, light, transparent and can be used anywhere, providing endless inspiration for new lifestyles and interior designs.

Schüco Openstyle room design system

Combinations that take your fancy

Schüco Openstyle works in any living space. In the kitchen, it's a practical midway system or it separates the utility room, while in the bathroom it can partition the shower area, or provide attractive screening in a dressing room. The range of designs and number of accessories make for countless combinations, free design and customised use.



Benefits

- High design variety
- Flexible use
- Designed for 16 and 19 mm panel material
- Can be used as a fixed or moving unit
- Custom division with bars is possible



Schüco Openstyle room design system

Functional flair



One concept, countless possibilities. The basic components of Schüco Openstyle are compatible with the Schüco Interior Systems sliding door system and open up countless possible uses. The system provides everything a contemporary office needs, with maximum functionality and a comfortable working environment.

**The office is the
new living room**



10

Room design
system

Schüco Openstyle room design system

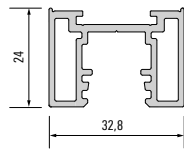
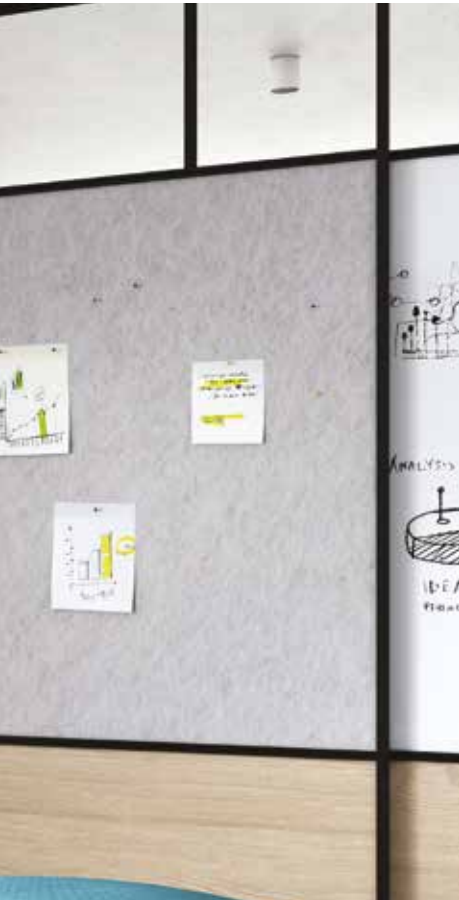

008656
Handle

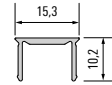

008664
Cover strip

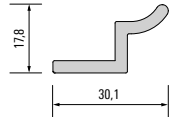

008673
Mounting rail

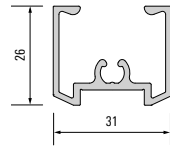

008677
Frame, top / bottom

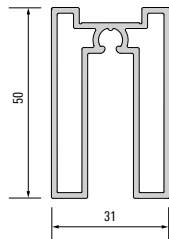

008683
Frame under roller fitting

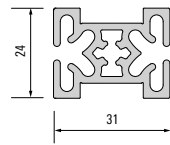

008687
Bar



MST sliding door system

Just keeps running ... and running ... and running



12

The sliding door system operates with barely a sound as it divides up spaces, creates new rooms or is fitted to wardrobes – whatever your lifestyle requires. It can be used in alcoves and sloping areas. The infills can be customised, with or without bars.

**Suddenly a
new room is
created**



MST handle profiles, frame profiles and guide tracks

Perfect in every respect



The handle and frame profiles complete the outstanding quality of the sliding door system, with technical perfection in an elegant design. Doors run along the guide tracks softly and almost noiselessly.

Benefits

- Smooth operation due to the top guide rollers
- Quiet operation thanks to self-centring track guide
- Possible door sizes of 2.00 m x 3.00 m (W x H)
- Possible door weights up to 100 kg
- System can be extended as required



MST handle profiles

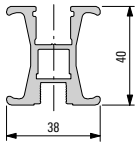

008317
Handle profile C

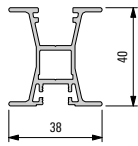

008436
Handle profile C Basic

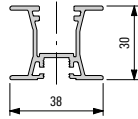

008370
Handle profile BAL

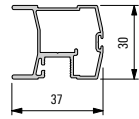

008391
Handle profile
brush seal BAL

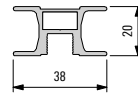

008442
Handle 20 C



MST frame and bar profiles

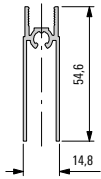

008314
Frame profile, bottom

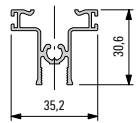

008439
Frame profile, top

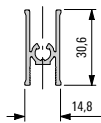

008377
Frame profile BAL
as frame, top

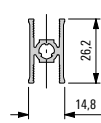

008364
Bar profile

MST guide tracks

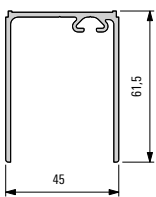

008353
Guide track, single

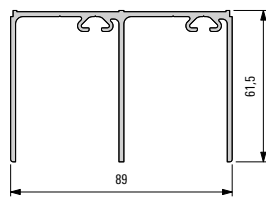

008350
Guide track, double

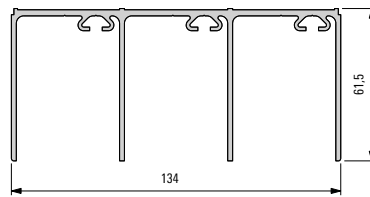

008340
Guide track, triple

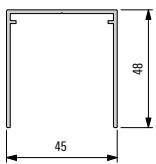

008397
Guide track, single

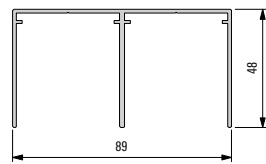

008387
Guide track, double

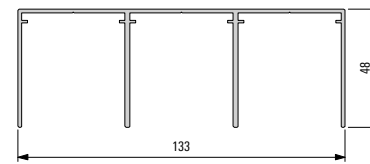

008393
Guide track, triple



MST accessories

Making life even easier



Brush seal carrier in the guide track protects against dirt and dust.

Roller carriage in the guide track – higher load-bearing capacity and smooth operation.

Rebate gasket – shock absorber for the rebate on the frame profile.

Soft closer – can be used for door widths from 540 mm (from 930 mm on both sides).

It slows down the door, draws it in and holds it in position.

MST floor track

Unobtrusive style



The discreet floor tracks are available as an embedded or surface-mounted version. The right choice depends on the type of floor covering. The surface-mounted track with flush design is perfect for stone and timber floors, as it has a surface area of just 4.5 mm. With multiple tracks, discreet joint covers or the respective flooring conceal any areas of unevenness at the cut edges of the flooring.

MST accessories

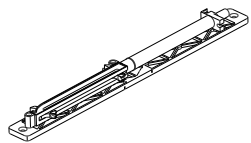
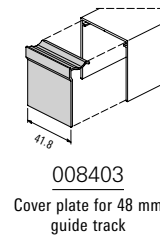
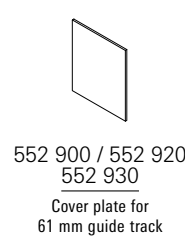
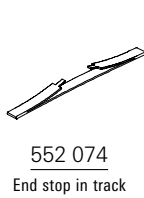
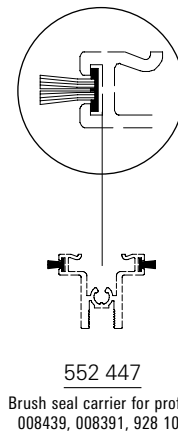
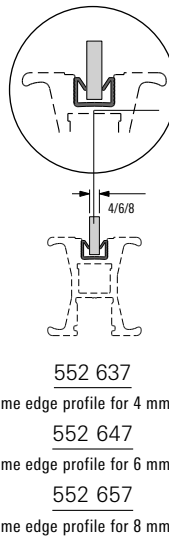
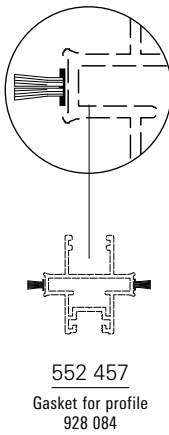
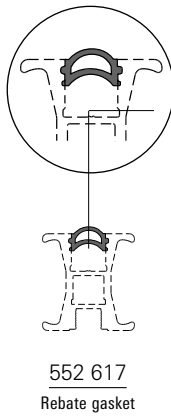

552 669.01/02 Class I: 10-20 kg
552 679.01/02 Class II: 20-40 kg
552 699.01/02 Class III: 40-60 kg
552 689.01/02 Class IV: 60-100 kg
Soft closer for 61 mm guide track, left/right, including pilot pin

552 669.03 Class I: 10-20 kg
552 679.03 Class II: 20-40 kg
552 699.03 Class III: 40-60 kg
552 689.03 Class IV: 60-100 kg
Soft closer for 48 mm guide tracks

Embedded floor tracks, with joint cover

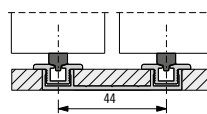
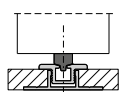
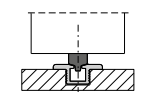
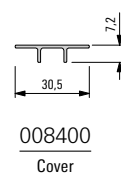
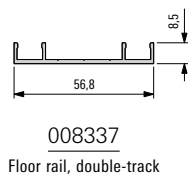
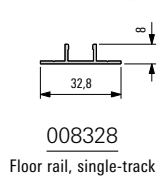
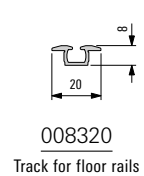

Surface-mounted floor tracks

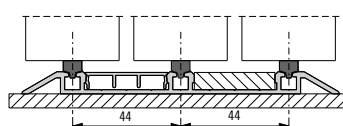
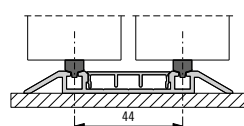
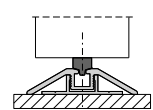
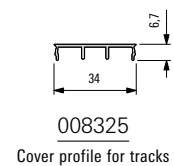
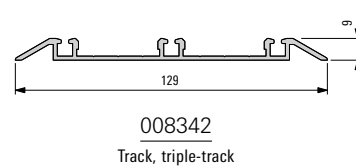
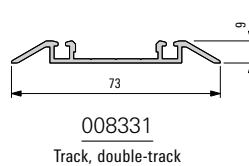
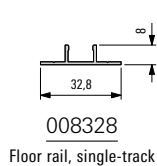
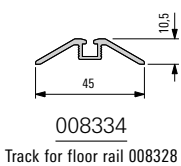

Surface-mounted floor tracks, flush design

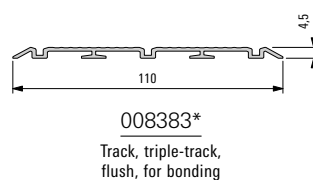
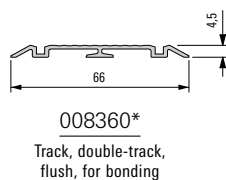
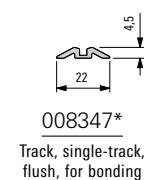

*No end stop possible

Schüco Smartcube shelving system

Much more than just a shape



A small, smart cube which offers plenty of creative freedom – cubes can be placed next to each other, on top of one another, on the wall, integrated in existing furniture or simply surface mounted. Schüco Smartcube works well anywhere – in the office, living room and kitchen, or wherever it is needed.



Products and systems with wonderful use of materials are presented at raumprobe, the largest exhibition for construction products and new materials, in their own "miraculous materials" section. For these new spaces, we were looking for a system which can showcase the range of different materials in a grand frame. The requirements were varied: flexibility and a large number of configuration options, a slimline look and high stability. The system is designed as a space-defining structure and should not be too obtrusive (as it is supposed to frame the exhibits and not steal the show). There were also requirements for smart functions such as integrated lighting, sliding units and storage. We struck gold with Schüco Smartcube, which promised to fulfil everything we were looking for. When we were setting up, we were also impressed by the precision and perfect preconfiguration. We now have a new display shelf to showcase our materials, the simplicity of which impresses both us and our visitors. The Smartcube has quickly become a real talking point.

Hannes Bäuerle, raumprobe

With an extremely wide range of possible uses, Schüco Smartcube can define an entire room design and add visual highlights – elegantly on the wall, integrated in the kitchen, and as single pieces of furniture such as a free-standing shelf or coffee table. The possibilities are endless.



Schüco Smartcube shelving system

One for all



Smartcube
is everywhere

A sophisticated product concept lays the foundations for an unbeatable system which is unrivalled in terms of its flexibility – so simple yet so complex.

Benefits

- Modular, flexible use
- Available in stainless steel and anodised black
- Side parts are pre-assembled
- Simple handling by means of packed sets
- Wide selection of corner cleats means the maximum number of options are possible
- Versatile accessories available



Schüco Smartcube shelving system

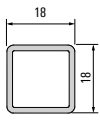

008598
Strut

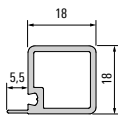

008583
Strut with support

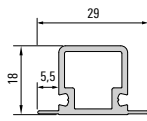

008634
Strut with support
Both sides

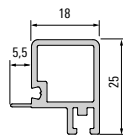

008625
Strut for sliding door,
top

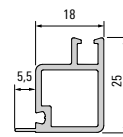

008629
Strut for sliding door,
bottom

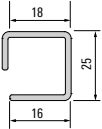

008697
Strut for midway system

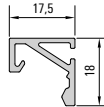

008702
Lighting profile

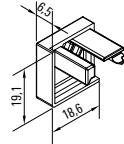

550 557
End cap, right

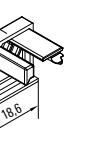

550 547
End cap, left

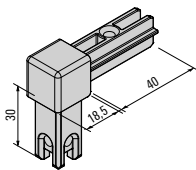

565 326
Corner joint, 2-sided

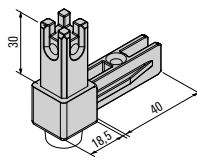

565 406
Corner joint, 2-sided,
with adjustable foot

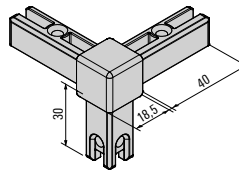

565 346
Corner joint, 3-sided

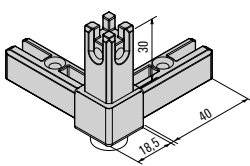

565 386
Corner joint, 3-sided,
with adjustable foot

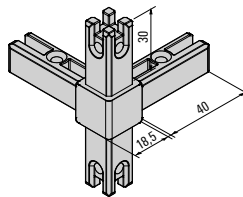

565 356
Corner joint, 4-sided

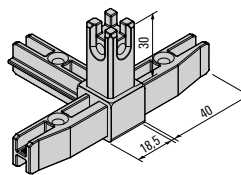

565 366
Corner joint, 4-sided
horizontal

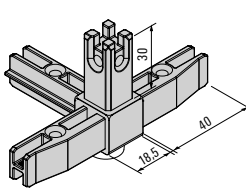

565 396
Corner joint, 4-sided, horizontal
with adjustable foot

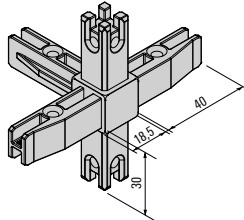

565 376
Corner joint, 5-sided

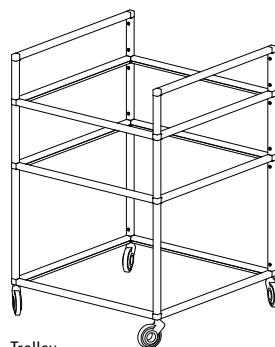
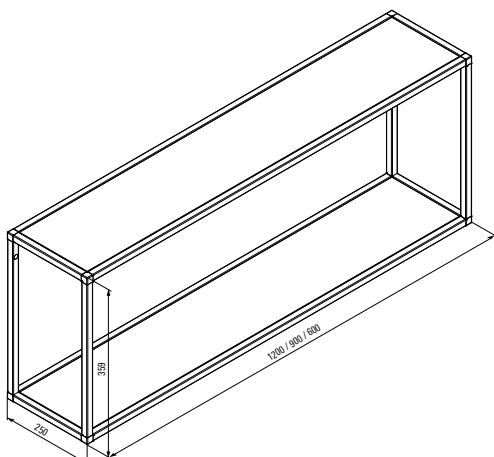

Trolley

Schüco Smartframe shelving system

Combination is key

Ideas are welcome. Schüco Smartframe provides the framework for endless possibilities for use and arrangements. The basic structure is made up of elegant aluminium frames that are available in two sizes and which support the shelves.

Benefits

- Modular, flexible use
- Available in stainless steel and anodised black
- Multiple kits can be combined



Schüco Smartframe shelving system

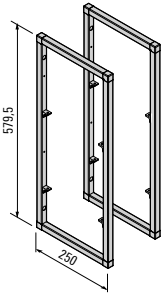

928 515
Kit for 580 mm
side component

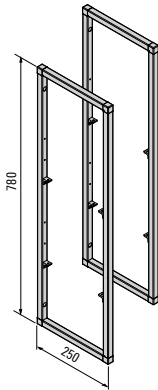

928 623
Kit for 780 mm
side component



Schüco Mandeo shelving system

The infinite shelving system



The Schüco Mandeo shelving system uses a simple principle to offer a number of design options. Robust aluminium profiles are used in this eye-catching frame system that enhances every living space. It provides additional storage space, showcases favourite pieces and is the perfect organisation system. Its design can be customised and extended as required. Individual frames can be combined for a flexible arrangement and look. They can then be attached to the wall, freestanding, or a combination of the two. There are virtually no limits.

The robust shelving frames are available in black and anodised stainless steel, forming the basis for a custom design. When combined with the various finishes and colours of the shelves, they create a design feature that suits any taste and lifestyle.

Schüco Mando shelving system

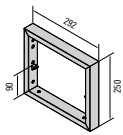

912 406
Frame 250 mm

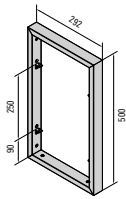

912 407
Frame 500 mm

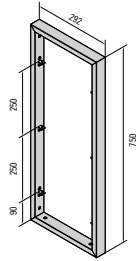

912 408
Frame 750 mm

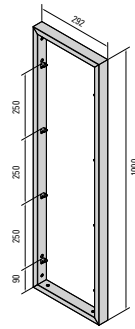

912 409
Frame 1000 mm

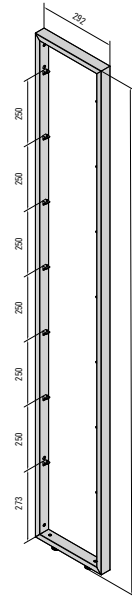

912 410
Frame 1950 mm



Schüco Illumacube shelving system

Light in its most beautiful form



We want to showcase our personalities through the things we love – especially during these times when we are mostly at home. We like to show favourite pieces, items with personal value, and things that are important to us. With Illumacube, Schüco sets the stage for these open areas with continuous lighting in front of the carcass. The kitchen becomes a personal, inviting space, while the hidden lighting creates atmosphere, for easy living.

Kristina Meyer, byform produktdesign



Schüco Illumacube showcases a piece of furniture, turns a cabinet into a stage, and adds ambience to a room. A frame with continuous light profile is mounted on a carcass as a unit to create ambient spaces with indirect lighting. Power is supplied via the corner cleats with just one cable outlet. This adds a homely touch to the kitchen, highlights design features in the bathroom, illuminates shelves with indirect lighting, and turns ornaments in a display cabinet into showpieces.

Schüco Illumacube shelving system

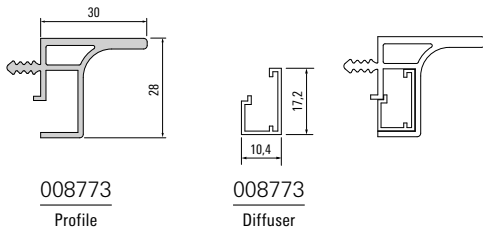
**Benefits**

- Frame is mounted in front of a carcass as a unit
- Just one cable outlet
- Integrated power supply via the corner joint
- Light output not immediately visible

Schüco Cone stand system

Slender yet robust

The striking front view contrasted with the slim profile face width are what set the Schüco Cone stand system apart. Visual presence meets effortless – something which is also clear in the combination of table and bench.



Schüco Cone stand system

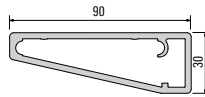
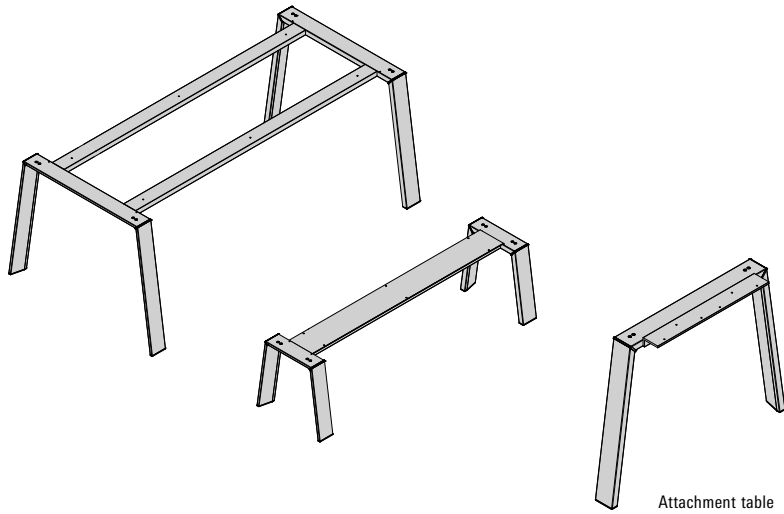

007553
Stand leg

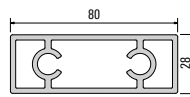

007558
Rectangular cross beam

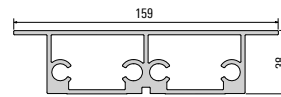

007568
Cross beam

**Benefits**

- High-quality stand system
- Concealed connections
- Can be a table, bench and sideboard substructure or attachment table
- Easy to assemble

Schüco Frame stand system

Sophisticated straight lines



Endlessly flexible, this system holds almost anything and can bear extremely high loads, both as a table frame or base frame underneath a sideboard or kitchen unit. With its consistent straight lines, Schüco Frame fits in perfectly with a linear room design, rounding off the furnishings nicely.

Benefits

- High stability
- Clear language of form
- Can be used as a table, bench and furniture substructure or attachment table



Schüco Frame stand system

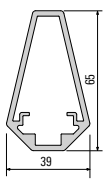
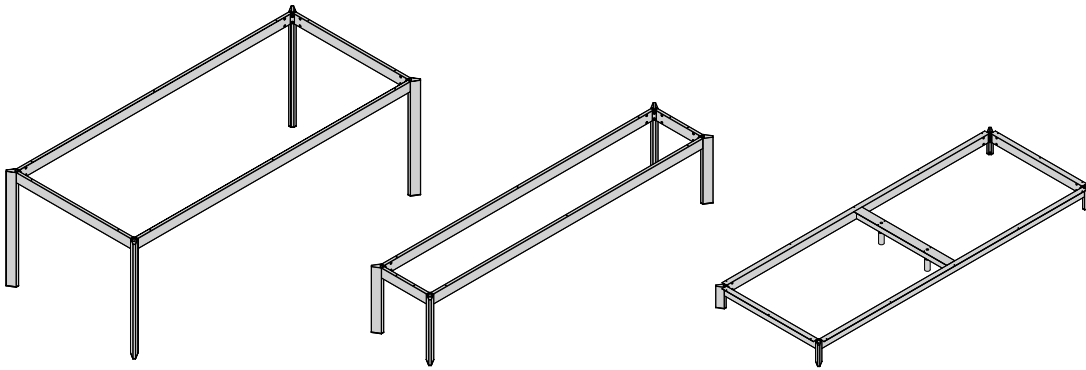

007581
Stand leg

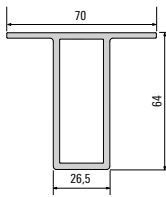

007587
Centre cross beam

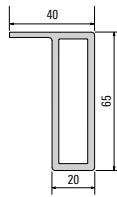

007595
Base cross beam

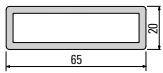

007578
Cross beam

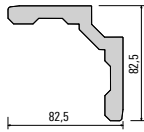

928 438
Corner cleat

Schüco Stair furniture leg

Elegant yet robust



Lightness meets stability. You don't notice the robustness of Schüco Stair at first glance. It adds a complementary, slimline and elegant finish for a piece of furniture and also looks impressive as a table leg.

Benefits

- Individual, slimline units convey a light, airy impression
- Height adjustment to level out unevenness of the ground
- Can be positioned under the piece of furniture in various ways



Plinth system

Function on top form



The Schüco plinth system adds an attractive finish to a kitchen. The high-quality aluminium plinth system features a high-tech appearance, with sophisticated technology that ensures optimum air circulation.

Benefits

- High-quality aluminium design
- Variable height and length
- Easy to attach to the kitchen base feet



32

Schüco Stair furniture leg

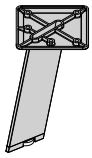

Kit

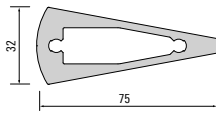

008692
Profile

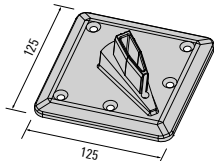

565 466
Bracket



565 457
End cap



Plinth system

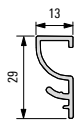

010752

Plinth cover, top



010758

Ventilation louvre blade

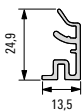
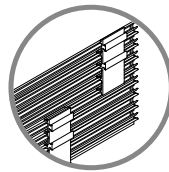
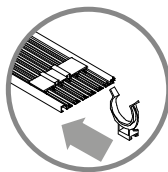

010767

Plinth cover, bottom

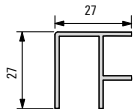

010775

Angled bracket



650 002

Sealing profile



530 097

Installation clips

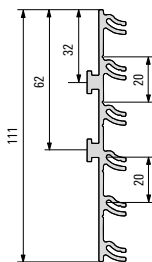

530 077

Plastic clip support

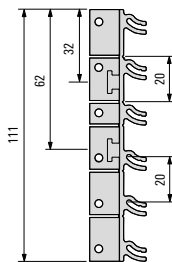

530 087

Plastic clip support, right/left

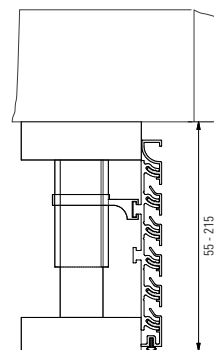

Ventilation cross-section:
54-490 cm²/m



Schüco Divaro design cover

Light and shadow



The Schüco Divaro design cover opens up completely new front views and creates both a visual and tactile experience. It lifts the overall appearance of a piece of furniture and living space, adding that certain *je ne sais quoi*. Elegant aluminium, an intriguing relief structure and wide range of options come together to form this design cover. A screw fixing is located at the bottom to make it easy to attach a handle.

Schüco Divaro design cover

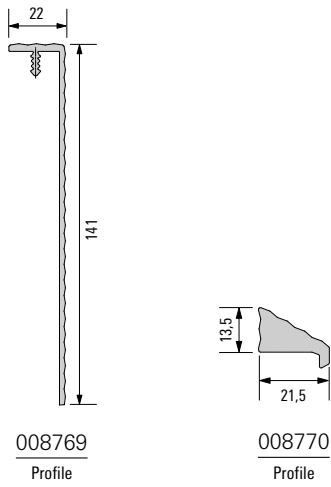
**Benefits**

- Elegant relief structure
- Can be arranged individually
- Integrated screw fixing for attaching a handle
- A design feature that goes far beyond the possibilities of a pull grip



Handlebars

Pleasing to the touch

A close-up photograph of a modern, light-colored handlebar mounted on a light green cabinet. The handlebar has a sleek, curved design with a brushed metal finish. The background is slightly blurred, showing a kitchen counter with some green items.

Handlebars are a key feature in the overall impression of a kitchen, living room or piece of furniture. They are equally as effective as a discreet detail or striking design feature that gives the entire piece that special something.



Details make all the difference

Benefits

- Exclusive design
- Bespoke
- Anodising of individual handlebars

Handlebars

Playing with shapes



Whether straight, curved, combined with different contours or intriguing surface textures – find the perfect handlebar to suit your personal taste and style.

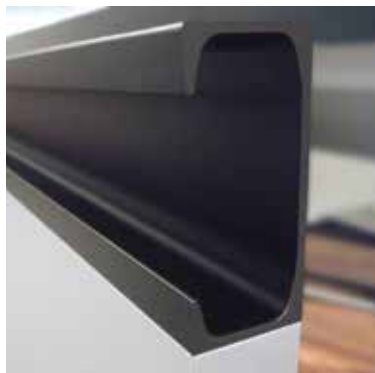

Handlebars

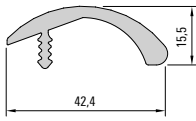

006874
Kanza profile

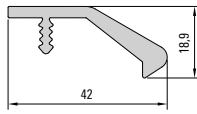

006899
Divido profile

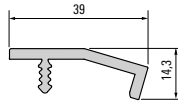

005977
Kontur profile

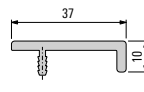

006196*
Profile

Handlebar 006196 is available from stock in silver, polished stainless steel and anodised black in packing units of 20.

*Made-to-measure handlebars are available as packing units in the standard lengths 295 – 1195 mm.

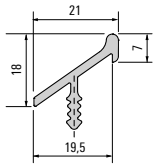

004699
Ladeo profile

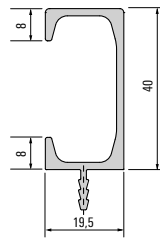

004457
Reta profile

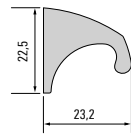

567 660
Denza profile

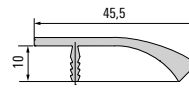

005819
Profile

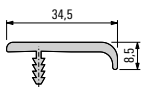

004370
Profile

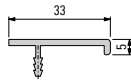

007956
Profile

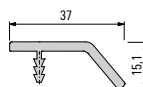

005141
Profile



005736
Profile

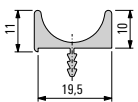

004047
Profile

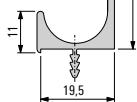

003999
Profile

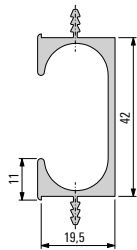

004063
Profile

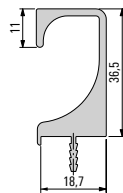

003959
Profile

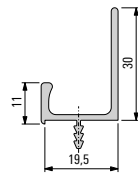

005192
Profile

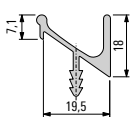

005177
Profile

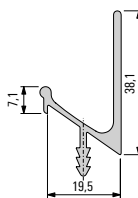

005156
Profile

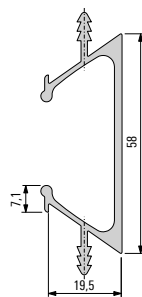

005185
Profile

Concealed handlebars

More than meets the eye



Yes to design, but with a discreet elegance. Concealed handlebars are the perfect answer to this. They maintain the flush look while their elegant profile face widths appear discreetly.

Benefits

- Handle-free appearance
- Maximum functionality
- Straight alignment

Handle recess

When less is more

Handle recesses become one with the front panel. They make a statement while slotting in flush with the unit. They are technically perfect, with outstanding quality and ergonomics.

Benefits

- Can be produced in any length
- End caps are simply pushed on



40

Concealed handlebars

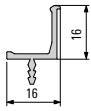
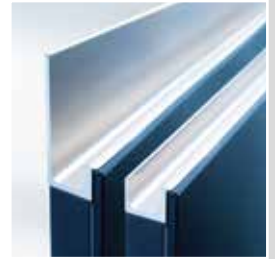

004617
Profile

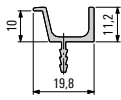

005489
Profile

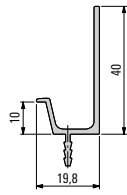

005434
Profile

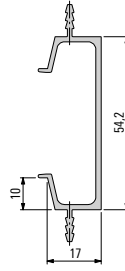

004651
Profile

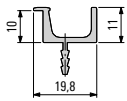

005350
Profile

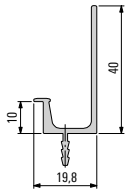

005531
Profile

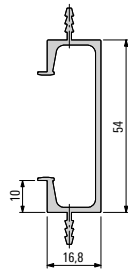

004678
Profile

Handle recess

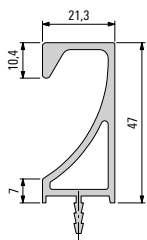

005317
Profile for 19 mm front depth

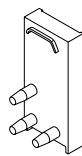

565 847.01
End cap for 005317, left silver

565 847.02
End cap for 005317, right silver

565 847.03
End cap for 005317, left stainless steel look

565 847.04
End cap for 005317, right stainless steel look



Recessed handles

Looks good, feels good



With their minimalist, unembellished nature, recessed handles are perfect for handle-free style. Technically perfect and ergonomic, they meet the need for top quality and convenience.

Benefits

- Complete accessories in high-quality, painted design
- Profiles available for the corner carousel cabinet and integrated dishwasher
- End caps and inner and outer corners are available
- Corner chevron for 135° solutions
- LED light strip option
- Integrated cable duct

Recessed handles

Horizontal orientation

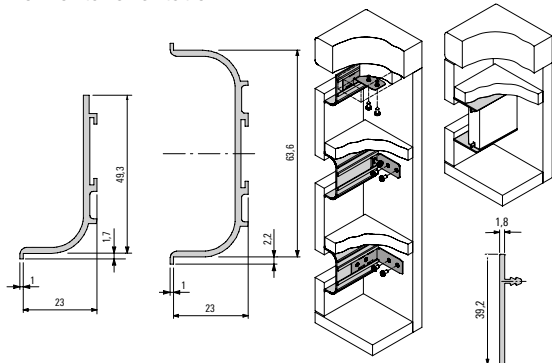

004264
Profile

004205
Profile

004472
Profile

Vertical orientation

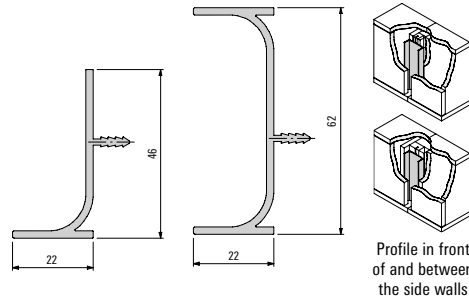

004117
Profile

004163
Profile

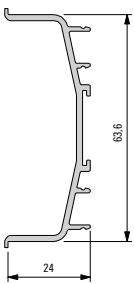

921 126
Profile

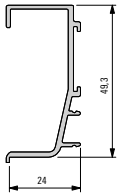

004871
Profile

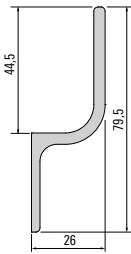

006773
Profile for corner carousel cabinet

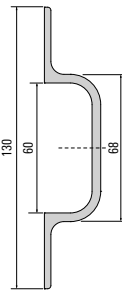

006774
Profile for corner carousel cabinet

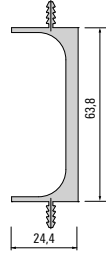

008493
Profile for integrated dishwasher

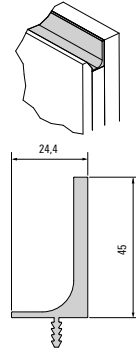

005805
Profile

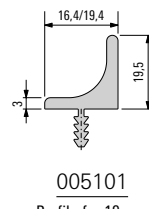

005101
Profile for 19 mm
005247
Profile for 16 mm

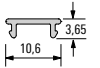

650 112
Diffusing panel, opal

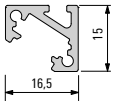

010956
Lighting profile

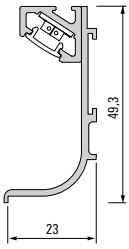

566 447*
End cap for 004264 flush

566 707
End cap for 004264 overlapping



566 477
End cap for 004205 flush

566 697
End cap for 004205 overlapping

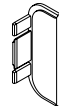

566 617*
End cap for 004264



566 607
End cap for 004205

*Left hand and right-hand design available

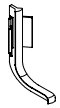

566 587
Corner for 004264 inner



566 597
Corner for 004205 inner

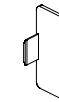

566 927.01
End cap for 004868



566 737.01
End cap for 004871 right



566 687
End cap for 004868

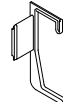

566 637.01
End cap for 004871 right



566 757.01
Corners for 004868 inner



566 727.01
Corners for 004871 inner

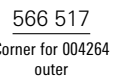

566 517
Corner for 004264 outer

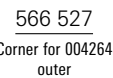

566 527
Corner for 004264 outer

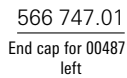

566 747.01
End cap for 004871 left

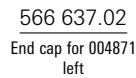

566 637.02
End cap for 004871 left

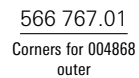

566 767.01
Corners for 004868 outer

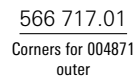

566 717.01
Corners for 004871 outer

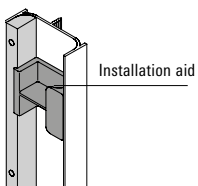

901 316
Filler profile for mounting electronic devices, 600 or 1150 mm

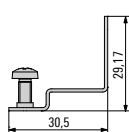

550 622
Fixing lug

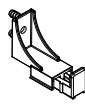

550 617
Fixing clip

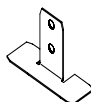

550 402
Fixing lug

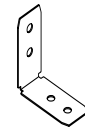

550 512
Fixing bracket

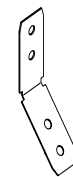

550 511
Corner chevron (135°)



551 544.30
Fixing lug

Glass frame systems

Form meets function



The creative arrangement options and different surface finishes turn these glass frame systems into real design features. They add a special, elegant touch to any room, wherever and however they are arranged. Available in different profile cross-sections and surface finishes. The new retaining profile, which can be used in conjunction with the new glass frame profiles 010737 and 010833, makes it easier to insert the fittings without extensive carcass work.

Benefits

- Particularly elegant look
- Different profile cross sections available
- Can be installed as a top-hung, side-hung, double or sliding door

Glass frame systems

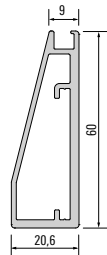

008407
Graphic profile

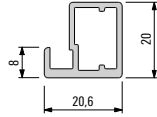

004600
Profile

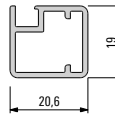

004525
Profile

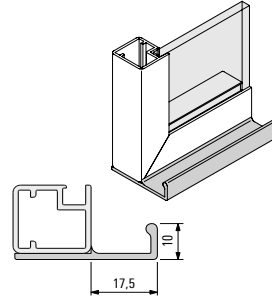

005123
Pull grip

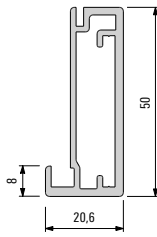

008123
Profile

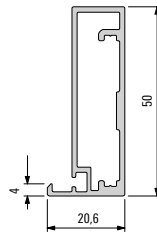

008192
Profile

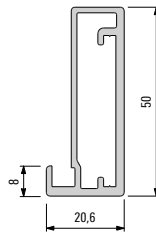

923 051
Profile

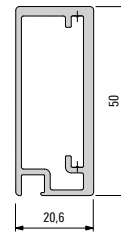

008205
Profile

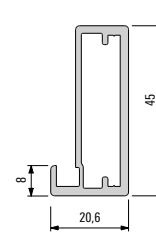

004512
Profile

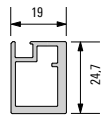

010737*
Profile

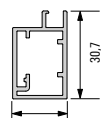

010833**
Profile

* For Salice Air fitting
** For Grass Tomos H, T-Slim fittings

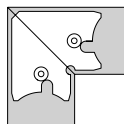

550 764.98
Corner cleat

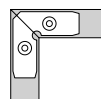

550 484
Corner cleat

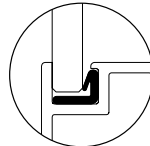

532 917
PEVA rattle protection

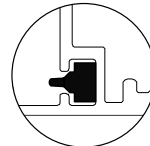

650 010
Gasket for profile 008192

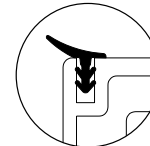

532 837
Moisture seal for profile 008123

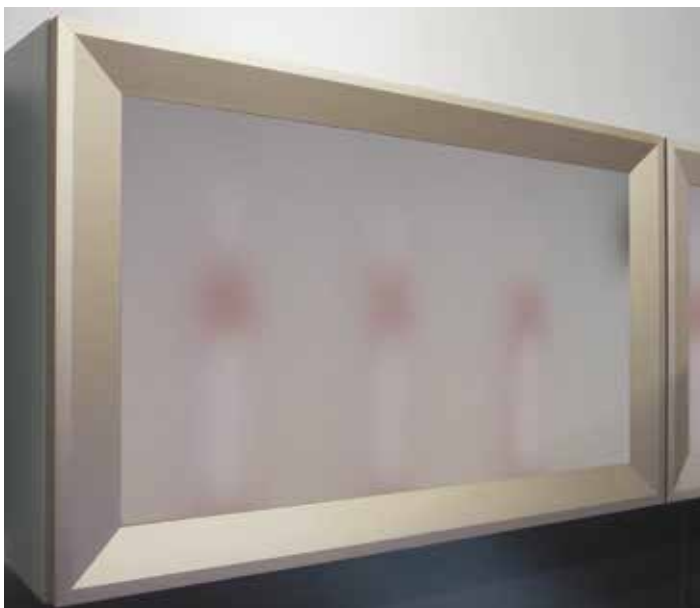

Glass frame profiles – bonded panes

They look as if they are floating

Lightness and transparency are on trend. The frame profiles for furniture fronts are perfect for this. Its bonded panes or a mount with a clear glass pane create a unit that appears to float.



Benefits

- Exclusive look
- Bonded glass panes provide invisible support for the frame



Edge and front frame profiles

The best protection

A decorative feature that protects. The design of the aluminium profiles is stylish, while their functionality is extremely practical, with high stability and concealed mitres.

Benefits

- Attractive edge cover
- Narrow visible surfaces

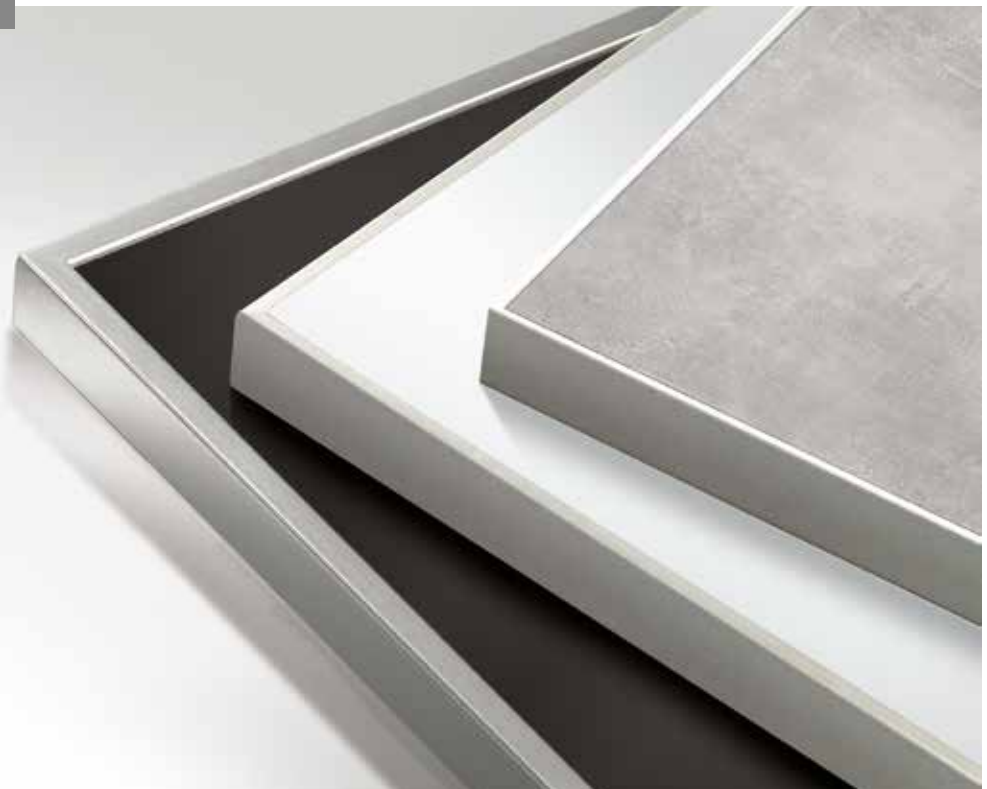

Glass frame profiles – bonded panes

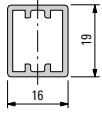

008109
Profile

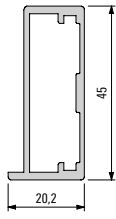

008120
Profile

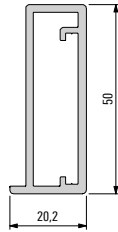

008141
Profile

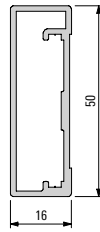

008184
Profile

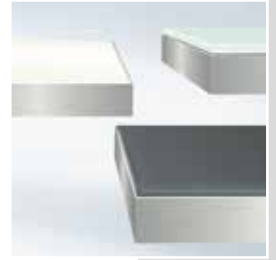

550 341.01
Sleeve for handle hole

110 040
15 mm adhesive strip

110 041
35 mm adhesive strip

Edge and front frame profiles

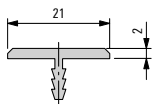

005035
Profile

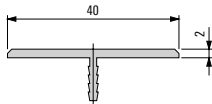

005017
Profile

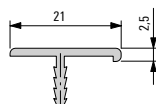

005025
Profile

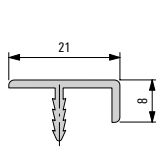
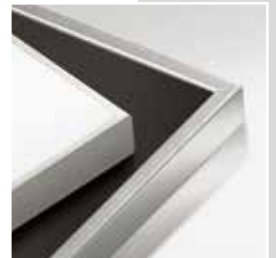

005030
Profile

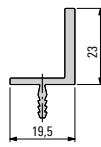

980 010
Profile

Schüco Kreativo wall system

Creativity without limits



Schüco Kreativo adds a special touch of character to entire rooms, creating structure in the kitchen, living room and office alike. Depending on requirements, a wide selection of practical, attractive accessories is available.

Benefits

- Open display
- High flexibility
- Optional lighting possible

Schüco Kreativo wall system

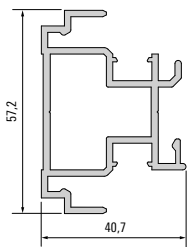
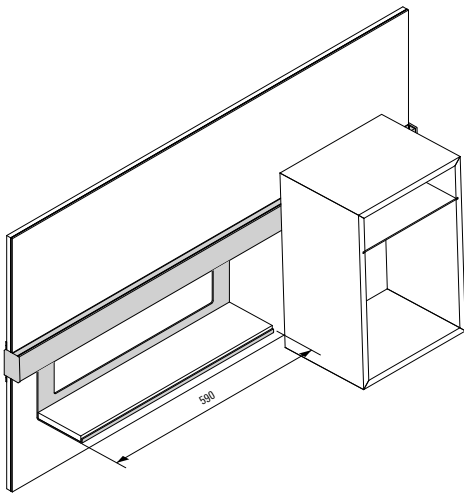

008569
Base support

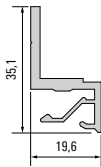

008573
Panel support

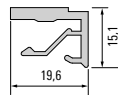

928 162
Cover strip

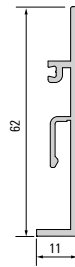

008576
Cover and support strip

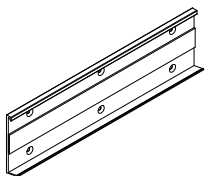

008580
250 mm mounting rail

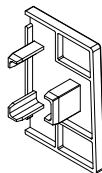

553 847.66
End cap, left



650 112
Opal dispersing lens

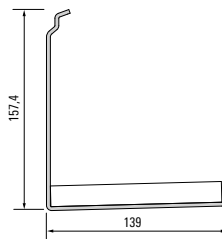

928 431
Shelf base

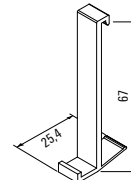

928 164
Hook

553 857.66
End cap, right

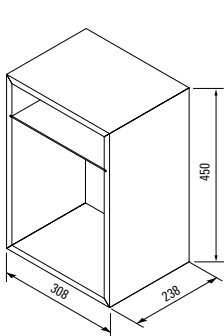

928 411
Box, open

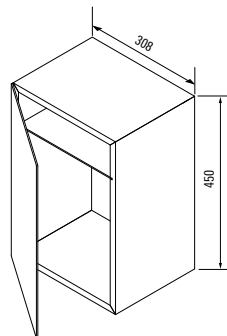

928 432
Box with door

Midway system 16

Cast from the same mould



The midway system 16 is ideally suited to usage in classic recessed areas. It creates a clean transition to the worktop and can also be used as practical wall cladding. It can hold all manner of utensils. With its elegant appearance, the midway system blends in with any room design.



50

Midway system 16

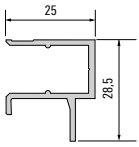

007423

Upper panel bracket 25

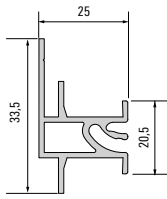

007411

Intermediate profile 25

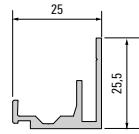

007417

Lower panel bracket 25

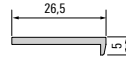

007429

Closer profile 25

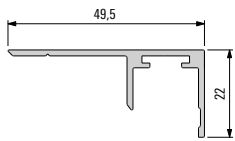

925 364.61.99

Upper panel bracket

Material: Aluminium profile
Surface finish: E6/EV1
anodised silver
PU: 20 units
each 4100 mm long

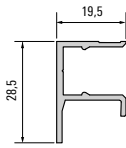

008488

Top profile

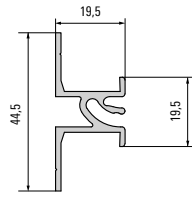

985 007

Intermediate profile

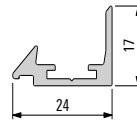

925 365.61.99

Lower panel bracket

Material: Aluminium profile
Surface finish: E6/EV1
anodised silver
PU: 20 units
each 4100 mm long



007264

Track profile for panels

Material: Aluminium profile
Surface finish: E6/EV1
anodised silver
PU: 3 m bar profiles
From 100 running metres

533 507.17 right
533 517.17 left

Upper end cap

Material: Plastic
Surface finish: Silver
PU: 20 units

533 527.17 right
533 537.17 left

Lower end cap

Material: Plastic
Surface finish: Silver
PU: 20 units

567 257.17

Push-in gasket

Material: Plastic
Surface finish: Silver
PU: 100 running metres

533 547.67

90° corner

Material: Plastic
Surface finish: Silver
PU: 20 units

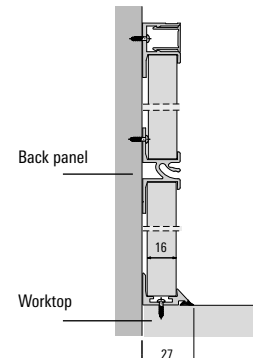
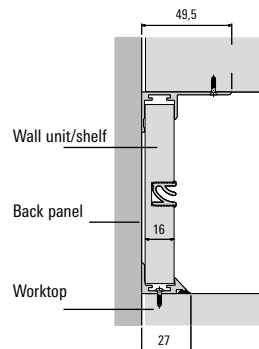

Benefits

- Smooth transitions between worktop and wall cladding
- Durable even under extreme conditions
- Seals prevent moisture ingress
- Simple installation without drilling holes in the wall
- Use of 16 mm thick panels
- Versatile accessories available

Midway system 4-18

A real "all-rounder"



With the midway system 4-18, the rear wall is also incorporated in the overall room design. A choice of timber or glass infills with a material thickness of up to 18 mm can be used. The available LED lighting creates more atmosphere. The range of different accessories are practical additions.

Benefits

- For material thicknesses from 4 to 18 mm
- LED lighting possible
- Can be used as midway cladding and wall panels
- Versatile accessories available

Panel system

Multitalented



The panel system meets many different requirements for individual use, and its attractive appearance always enhances different living spaces. The accessories can be used in a number of different ways and can hold heavy objects too.

52

Benefits

- Panels from 16 to 21 mm can be used
- A number of usage options in the living and working environment
- Easy to install without special tools
- Versatile accessories

Midway system 4-18

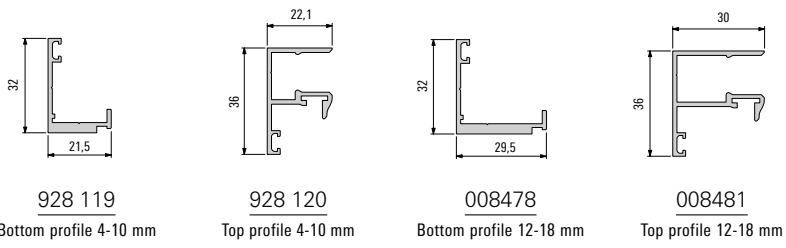

928 119
Bottom profile 4-10 mm

928 120
Top profile 4-10 mm

008478
Bottom profile 12-18 mm

008481
Top profile 12-18 mm

Niche mounting

(8 mm example)

(10 mm example)

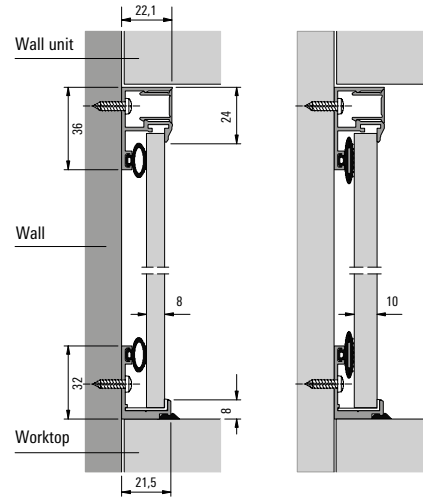

552 307
Rebate gasket

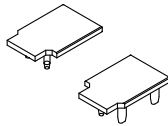

530 017
End caps, left

530 027
End caps, right



650 101
Edge protection
567 257.17
Push-in gasket
Material: Plastic
Surface finish: Silver
PU: 100 running metres

Panel system

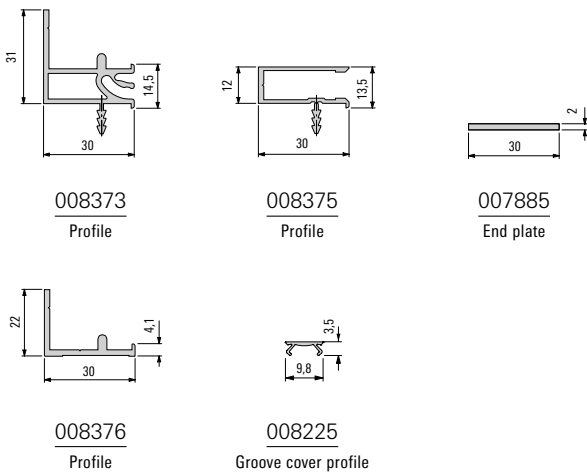

Wall-mounted installation

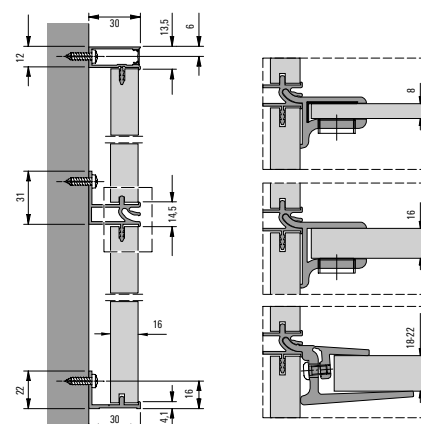

Schüco Groove hanging rail

The perfect storage for everything



The Schüco Groove hanging rail is at the heart of the versatile accessories. With its discreet look, it can hold any item you need to grab quickly. The lighting above gives it a pleasant radiance.

Schüco Groove wall attachment profile

Smooth transitions

The Schüco Groove closer profile creates an attractive connection between the rear wall and worktop. The lighting adds additional drama.



Schüco Groove hanging rail

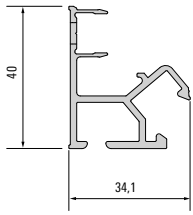

008534
Hanging rail

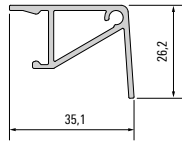

008543
Cover



650 103
Dispersing lens

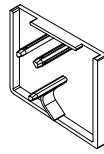

553 827
End caps, left

553 817
End caps, right



Benefits

- Elegant design
- LED strip adds attractive lighting accents
- Works perfectly with the Schüco Groove wall attachment profile
- Versatile accessories available

Schüco Groove wall attachment profile

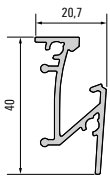

008555
Wall attachment profile 2

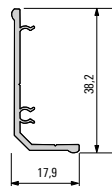

650 107
Plastic basic profile



650 103
Dispersing lens

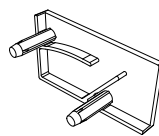

553 767
End caps for wall attachment profile 2, left

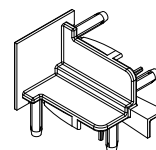

553 797
90° corner piece for wall attachment profile 2

553 757
End caps for wall attachment profile 2, right



Benefits

- Stylish design feature for any kitchen
- Integrated LED lighting
- Can be installed on the wall or worktop

Accessories for midway and wall systems

We've thought of everything



Where do you put all those kitchen utensils? This will no longer be an issue thanks to our range of accessories which covers everything – from knife block and roll holder through to hook rail, and much more.

Benefits

- Perfectly tailored to the Schüco Groove hanging rail and the midway systems
- Varied range to meet any requirement
- High quality and stability
- Accessories suitable for the Linero holding rail

Accessories for midway and wall systems

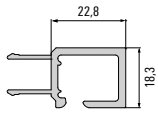

928 129
Linero system rail

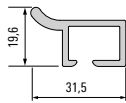

008345
Linero function strip

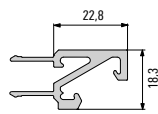

008485
Lighting profile

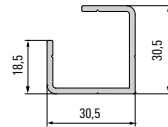

928 128
Corner profile



650 103
Dispersing lens



008467
Cover profile

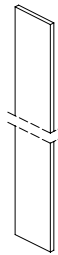

007491
End plates, flat profile, 20 x 2 mm

010793
End plates, flat profile, 22 x 2 mm

007885
End plates, flat profile, 30 x 2 mm

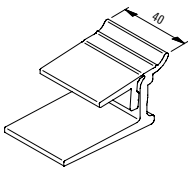

928 069.70.99
Bracket for timber base
18-22 mm

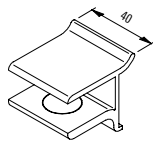

902 605.61.99
Bracket for timber base
16 mm

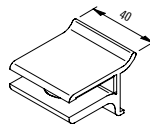

902 625.61.99
Bracket for glass base
8 mm

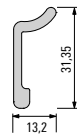

007038
Mounting profile
for panel bolt

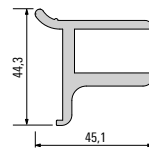

007057
Support profile
for 16 mm base

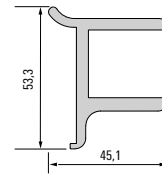

007428
Base support profile
25 mm

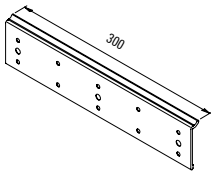

928 091.73.99
300 mm mounting rail
with clamping lug

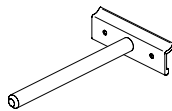

902 622.00.99
Base support



902 273.70.99
Attachment hook

902 149.73.99
300 mm mounting rail
without clamping lug



928 407
Roller holder



553 720
Hanging rail



553 790
Universal mount



928 406
Knife block



553 740
Hook rail

553 710
Hanging rail, closed

553 780
Universal mount, closed

928 405
Knife block, closed

553 730
Hook rail, closed

Schüco Spaceline drawer organiser

The joy of organisation



Huge impact with little effort. Schüco Spaceline organises drawers in a number of different ways with just a few individual components. You can quickly put together large compartments, small compartments, and combinations thereof in any way you like.

58



Schüco Spaceline drawer organiser

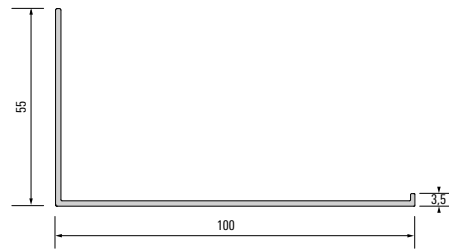

008447
Divider profile

**Benefits**

- Just a few components can fully equip the drawers
- Flexible layout
- High-quality combination of materials



300 mm

600 mm



1200 mm



Schüco Tara storage recess

Two in one

It's what's inside
that counts

The first benefit: Schüco Tara stores all the kitchen utensils that need to be stowed away. The second benefit: It is fully integrated in the work surface, taking up no space.

Benefits

- More storage space
- High functionality
- Easy to install
- Easy to retrofit

60

Schüco Tara storage recess

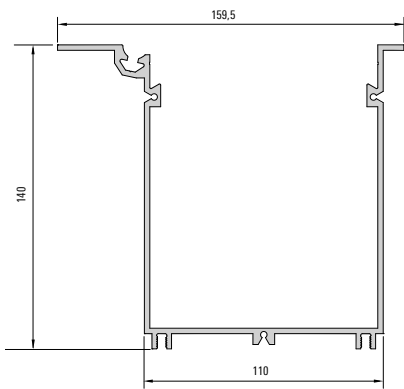

008558
Trough

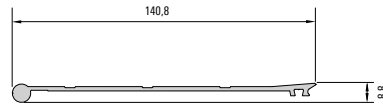

008562
Cover

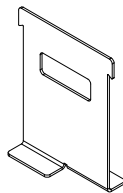

553 850
Partition wall

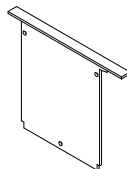

928 416
End bracket



566 787
Gasket cord \varnothing 4.0 mm

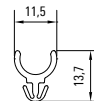

650 111
Bracket



553 802
Worktop tray



928 410
Bottle holder

Lighting profile

Highlight

We all know that light gives each room a special ambience. Indirect lighting creates a comfortable, warm environment, making a kitchen look homely or providing functional lighting when placed correctly. The lighting profiles can be positioned both in the wall unit and in a recess.

Benefits

- Discreet design
- Functional and ambient lighting



CD and DVD rack

Practical, quick and easy

You can quickly and easily organise and find the CD or DVD you're looking for. The racks can be expanded as required and integrated in any furniture system.

Benefits

- Easy organisation of your CDs and DVDs
- Can be integrated in any furniture system
- Can be expanded as required



Lighting profile

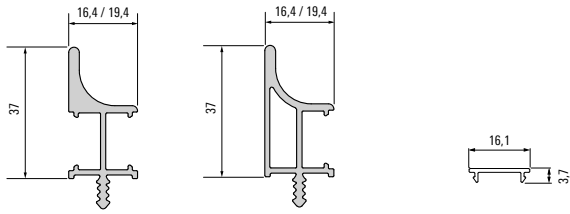

008515

Profile for 16 mm

008529

Profile for 16 mm

650 108

Dispersing lens, clear

008507

Profile for 19 mm

008518

Profile for 19 mm

650 109

Opal dispersing lens



CD and DVD rack

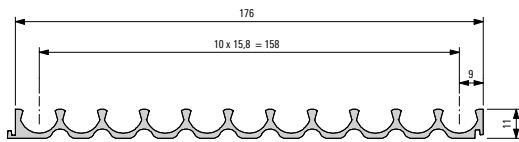

007272

CD rack for 11 CDs

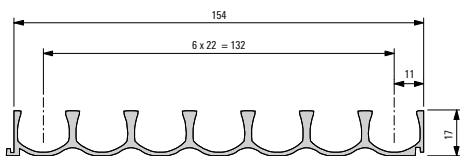

007370

DVD rack for 7 DVDs



Connecting profiles for worktops

Chic and neat

Aluminium connecting profiles are the perfect solution for small offsets at an intersection between two rounded worktops. This eliminates the need for mitred and shaped cuts.

Benefits

- Clean connections at corner joins
- No need for mitre cuts
- Can be used on the right and left



Carcase corner cleat profiles

Perfectly concealed

Want that perfect finish for your mitred edges? Look no further – carcase corner cleat profiles can fill this gap and provide an additional design feature.

Benefits

- Function meets elegant design
- Streamlined design



Connecting profiles for worktops



910 200

Profile cross-section
for finished components

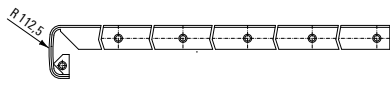

901 843

Length: 601 mm



Carcase corner cleat profiles

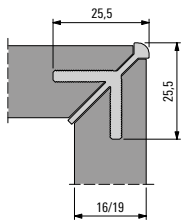

007142

Profile for 19 mm

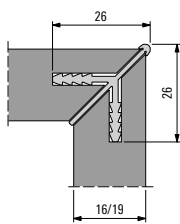

007919

Profile for 16 mm

007934

Profile for 19 mm

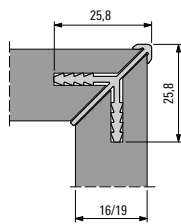

007922

Profile for 16 mm

007941

Profile for 19 mm



Ventilation grille

Well ventilated – always

In addition to meeting technical and functional requirements, the ventilation grilles feature an attractive design, and are robust and easy to clean.

Benefits

- Can be adapted to suit any furniture design
- High-quality, robust, easy-care material
- Easy to install and dismantle

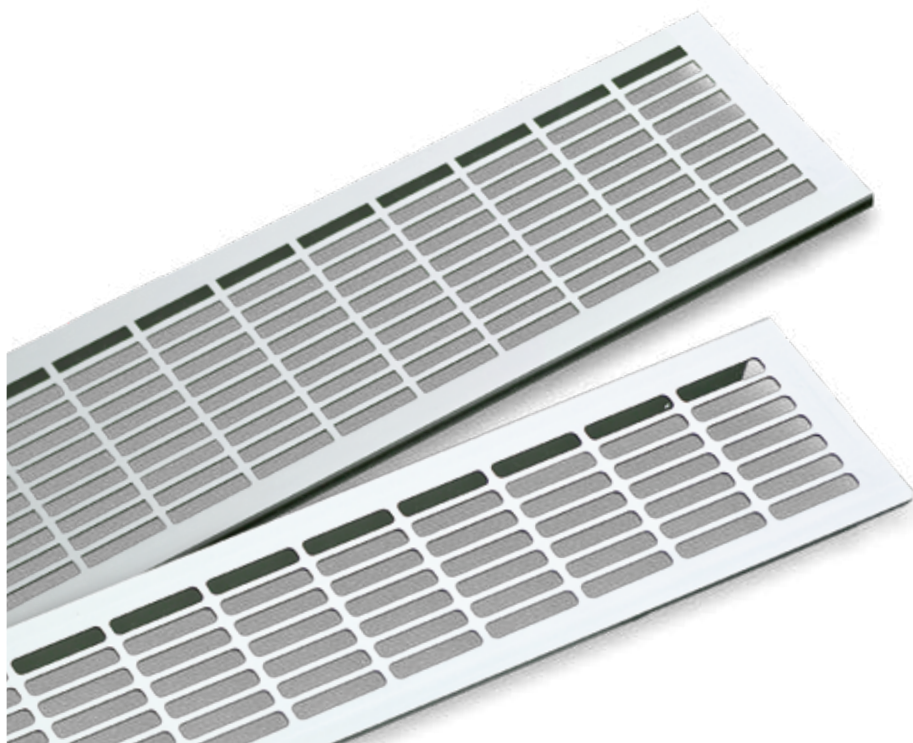

Roller shutter systems

Rolling on quietly

As it should be – silent, easy and technically perfect – these roller shutter systems meet all your needs. Up and down, horizontally and vertically. They also look great to boot!

Benefits

- Smooth operation
- Horizontal and vertical installation possible



Ventilation grille

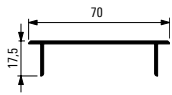

921 531
Rectangular, 30 x 6 mm
Ventilation cross-section:
313 cm²/m

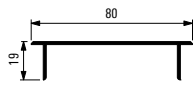

921 571
Oval, 30 x 6 mm
Ventilation cross-section:
358 cm²/m

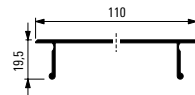

921 541
Rectangular, 30 x 5.7 mm
Ventilation cross-section:
496 cm²/m



Angled louvre blades

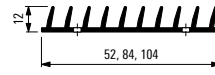

921 310 / 921 320 / 921 330
Width = 52, 84 and 104 mm
Variable length up to 1000 mm



Roller shutter systems

Shutter design

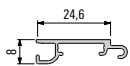

007179
Slat profile, smooth

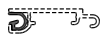

650 088
Retaining profile

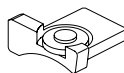

565 907.05
Slat end cap, left

565 907.06
Slat end cap, right

End profile

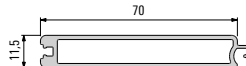

007150
End profile 12

551 947.03
End cap for profile, right

551 947.04
End cap for profile, left



Unit accessories

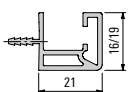

008255
Guide profile for counterbalance, 19 mm, unit side

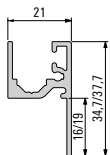

925 063
Guide profile for spring mechanism, 19 mm, unit side

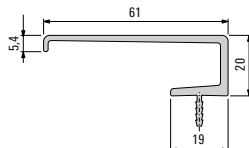

008233
Cover profile

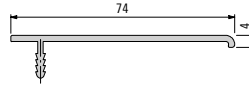

011107
Cover profile

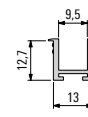

650 079
Plastic guide track



552 677.03
Cover cap for guide profile 008255, left

552 677.04
Cover cap for guide profile 008255, right

Notes

Your area sales manager will be happy to give you more information about stock availability, sizes, purchase quantities etc. Many of our collection articles, colours and sizes can be produced for you on an order-specific basis.

We will be happy to advise you about minimum order quantities, delivery times and available stock.

P4507/EN/04.22/Printed in Germany

We reserve the right to make changes and to correct errors.

Products may differ from illustrations.

The "Schüco" logo and other logos are protected in Germany and various international markets. Detailed information is available on request.

Changing living spaces



Schüco supplies a range of room design and furniture systems which meet all the requirements for openness, transparency and multifunctionality, while following the latest living and style trends. Sophisticated product concepts are the perfect foundation for dissolving space limitations, furnishing rooms and allowing new spaces to merge. The systems can be combined and expanded in any way you like. The range also features an extensive choice of accessories for all types of application in various living environments.

Schüco – System solutions for windows, doors and façades

Based in Bielefeld, the Schüco Group develops and sells system solutions for windows, doors and façades. With 6330 employees worldwide, the company strives to be the industry leader in terms of technology and service both now and in the future. In addition to innovative products for residential and commercial buildings, the building envelope specialist offers consultation and digital solutions for all phases of a building project – from the initial idea through to design, fabrication and installation. Schüco works with 10,000 fabricators and 30,000 architectural practices, as well as construction professionals who commission buildings around the world. Founded in 1951, the company is now active in more than 80 countries and achieved a turnover of 1.995 billion euros in 2021. For more information, visit www.schueco.com

SCHÜCO

Schüco Interior Systems KG

Werk Borgholzhausen

In der Lake 2, D-33829 Borgholzhausen, Tel. +49 5425 12-0, Fax +49 5425 12-236

interior-systems@schueco.com, www.schueco.com/interior-systems