

## Designgriffe Design handles



## Griffe für die Sinne. Handles for the senses.

Es fühlt sich irgendwie besonders an – harmonisch und schmeichelnd. Der Blick bleibt an einem kleinen Detail hängen – etwas, das dem Ganzen einen speziellen Ausdruck verleiht. Und im täglichen Gebrauch ist kaum spürbar, dass dieses Etwas auch noch die Aufgabe hat, eine Funktion zu erfüllen. Haptik, Optik und Funktionalität sind im Einklang. Sinnvolle Griffe – genau das war das Ziel von Schüco Interior Systems bei der Entwicklung der neuen Griff-Kollektion. Inspiriert von Elementen aus anderen Ländern, Kulturen und Kunstepochen, produziert mit perfektem Know How und perfektioniert in der Funktion ist eine Kollektion entstanden, die die Sinne für Ästhetik und gleichzeitig Funktionelles weckt. Wir wünschen Ihnen viel Spaß damit!

It feels like something special – smooth like silk. Your view lingers on the smallest details that give the whole product a unique character. In daily use, you can barely notice this is something that fulfils a purpose. The feel, look and function are in harmony. To create meaningful handles – this was the goal of Schüco Interior Systems when developing the new handle collection. Inspired by elements from different countries, cultures and artistic movements, produced using expert knowledge and with perfected functions, we created a collection that triggers the senses in terms of both aesthetics and functionality. Enjoy!

Ihr Your  
Schüco Team

## Inhalt Contents

Trends Trends	3
Kollektion Collection	26
Produktübersicht Product overview	52

# Trends

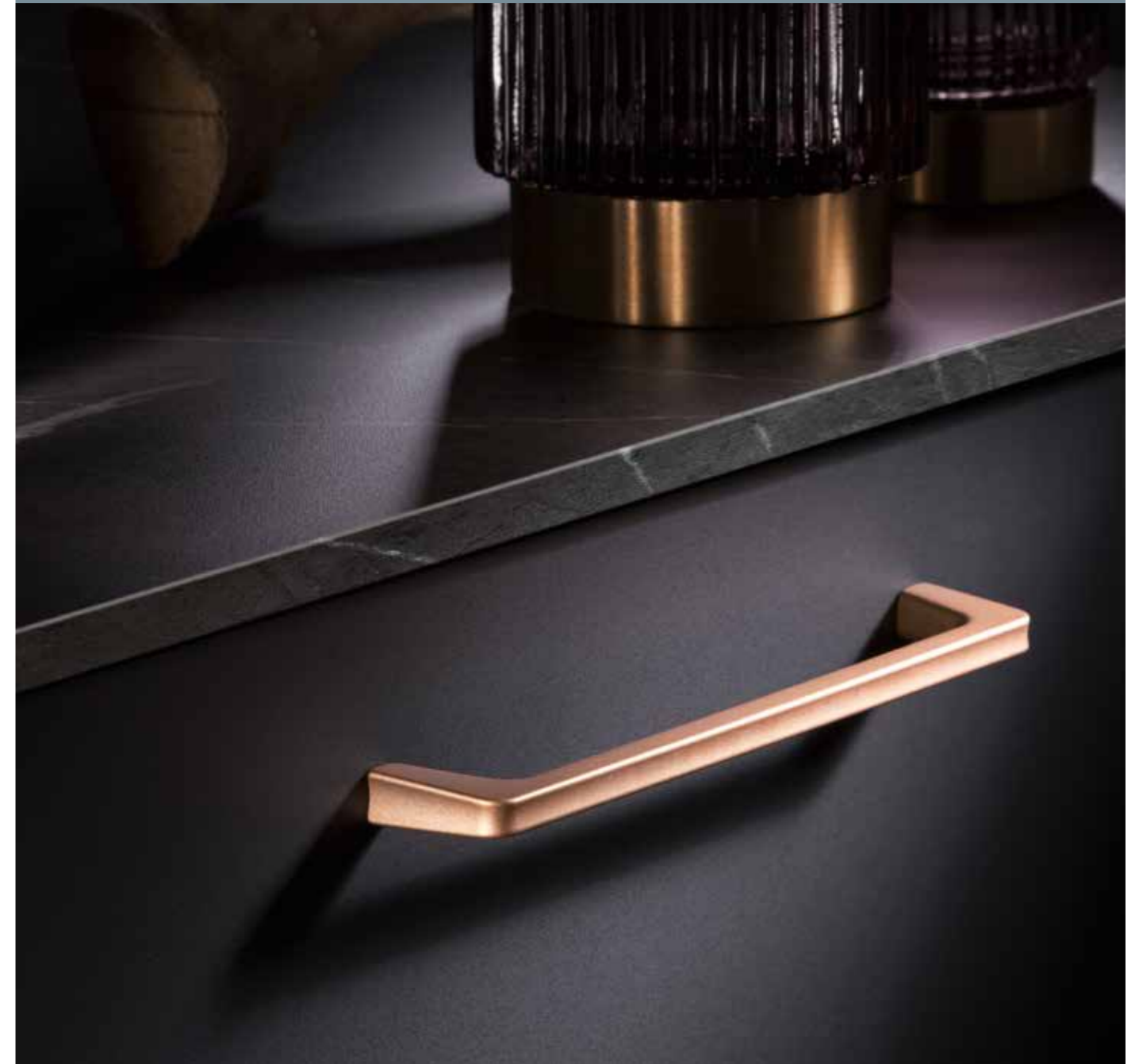

**Essential** Die Basics im Fokus · **Dekor** Ein Dialog von Formen · **Slim-Line** Die Feinsinnigen · **Formation** Die dritte Dimension · **Different** Das gewisse Etwas · **Essential** Focusing on the basics · **Dekor** An interplay of shapes · **Slim-Line** The subtle approach · **Formation** The third dimension · **Different** That certain something



Die Basics im Fokus  
Focusing on the basics

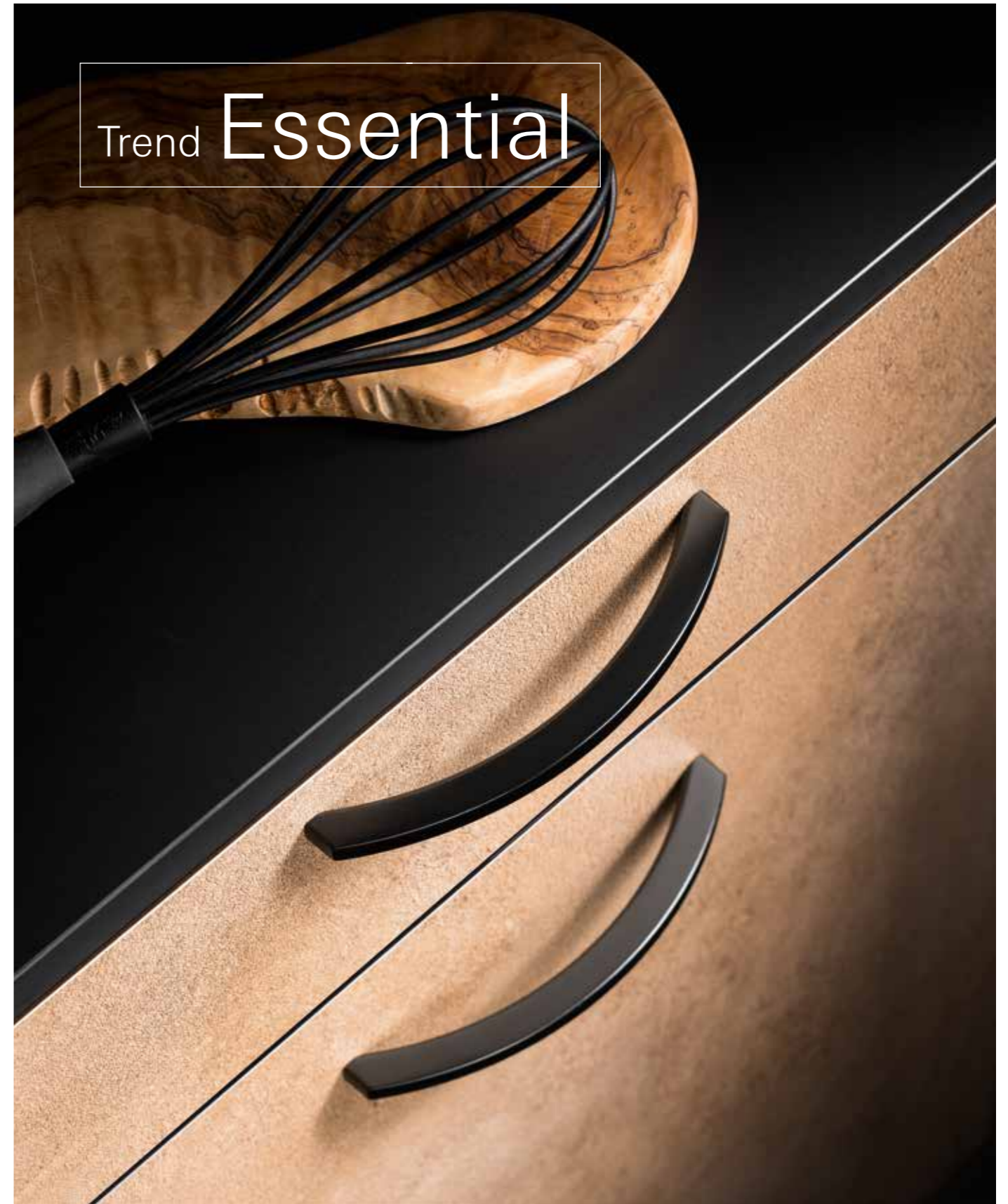

Reduziert auf das, worauf es ankommt. Klarheit und Eindeutigkeit zeichnen die Griffkreationen dieses Trends aus. Bei aller Konzentration auf das Wesentliche ist die Wirkung dennoch verblüffend. Weniger ist eben oft mehr.

Pared down to what matters. Clarity and simplicity set the handles of this style apart. When the focus is on the essentials, the effect is no less striking. Less is just as often more.





Art.-Nr. 040 030 RENDO

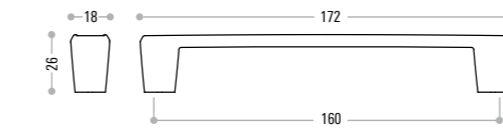
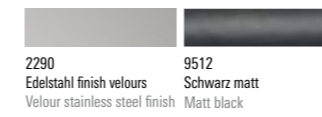

Art.-Nr. 040 031 ARUSA

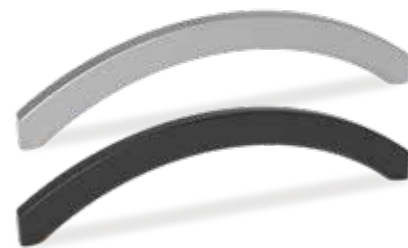
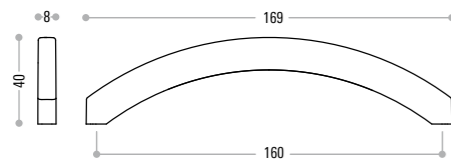



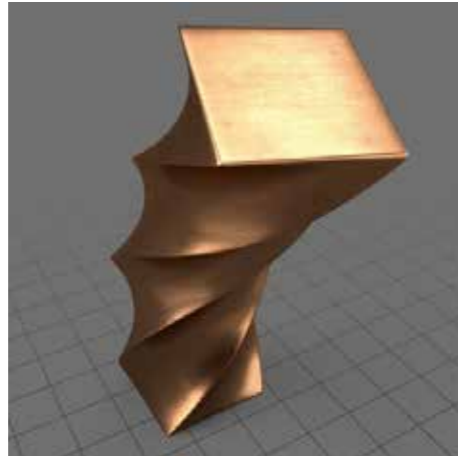

Ein Dialog von Formen  
An interplay of shapes

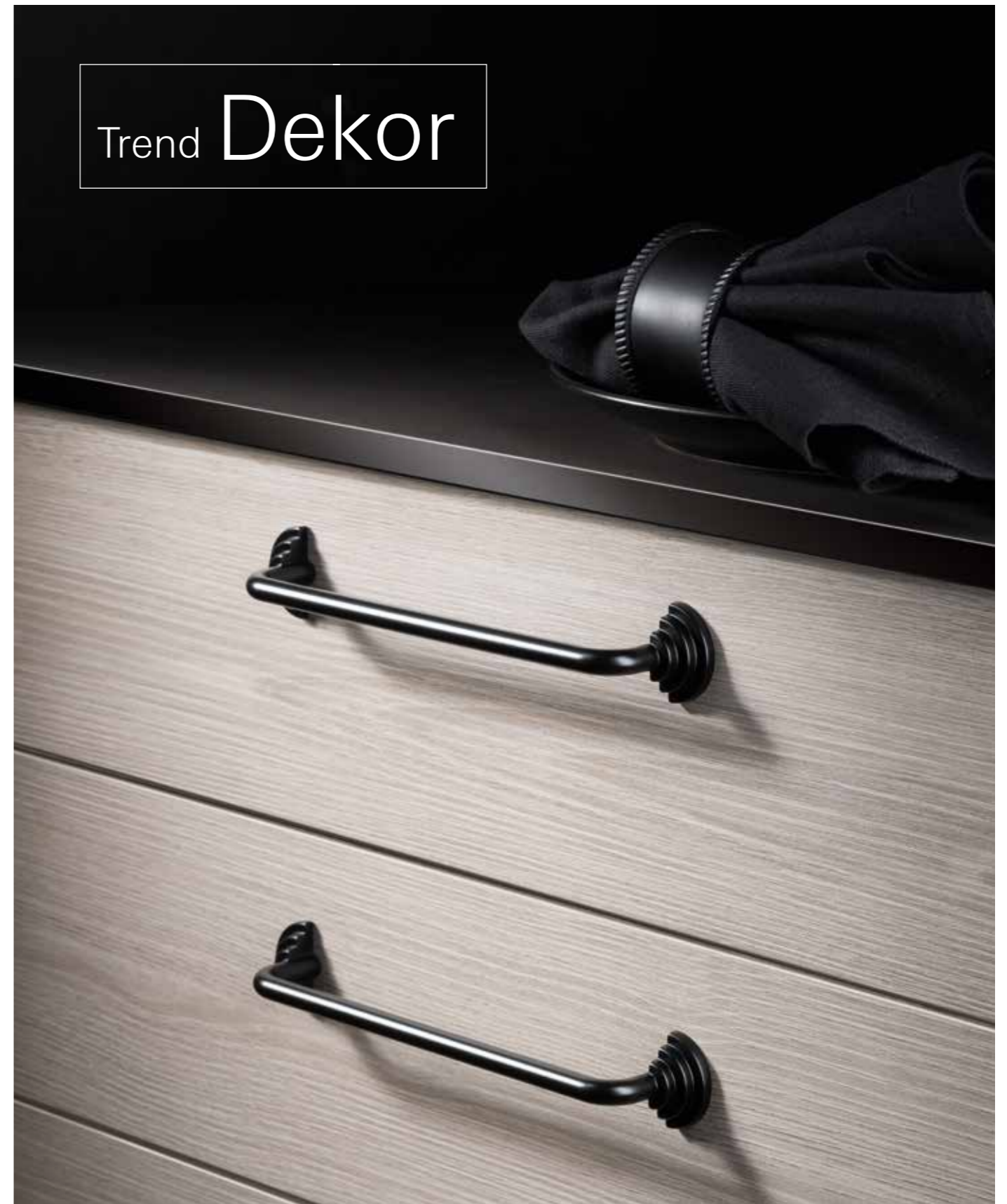

Grenzenlose Impressionen gekonnt in einem harmonischen Ganzen vereint. Netzstrukturen treffen auf Wellen, gerade Linien kombiniert mit weichen Schwüngen. Opulent, nahezu majestätisch, setzen sich die Dekor-Griffe in Szene. Neben Design und Haptik wurde auch an perfekte Funktionalität gedacht.

Endless forms skilfully combined into a harmonious whole. Rigid structures meet waves and straight lines combine with soft curves. Dekor handles give their surroundings an opulent, almost majestic feel. Attention has also been paid to perfect functionality alongside the design and feel.



Art.-Nr. 040 038 MIRVA

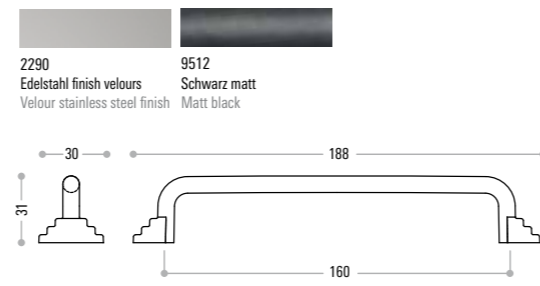

Art.-Nr. 040 032 BRILAC

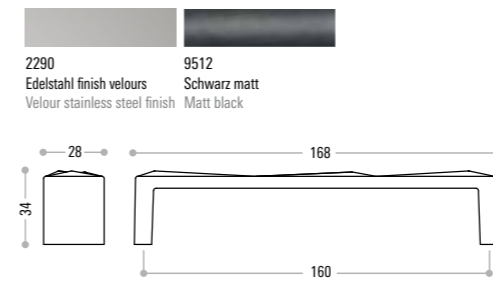

Art.-Nr. 040 033 XANTA

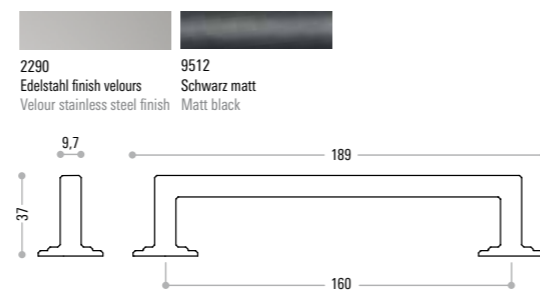





Art.-Nr. 040 037 YAVI

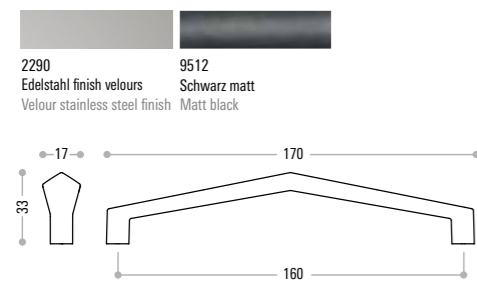

Art.-Nr. 040 041 CHELIN

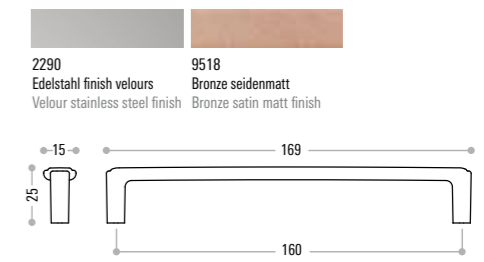

Art.-Nr. 040 042 ZESIA

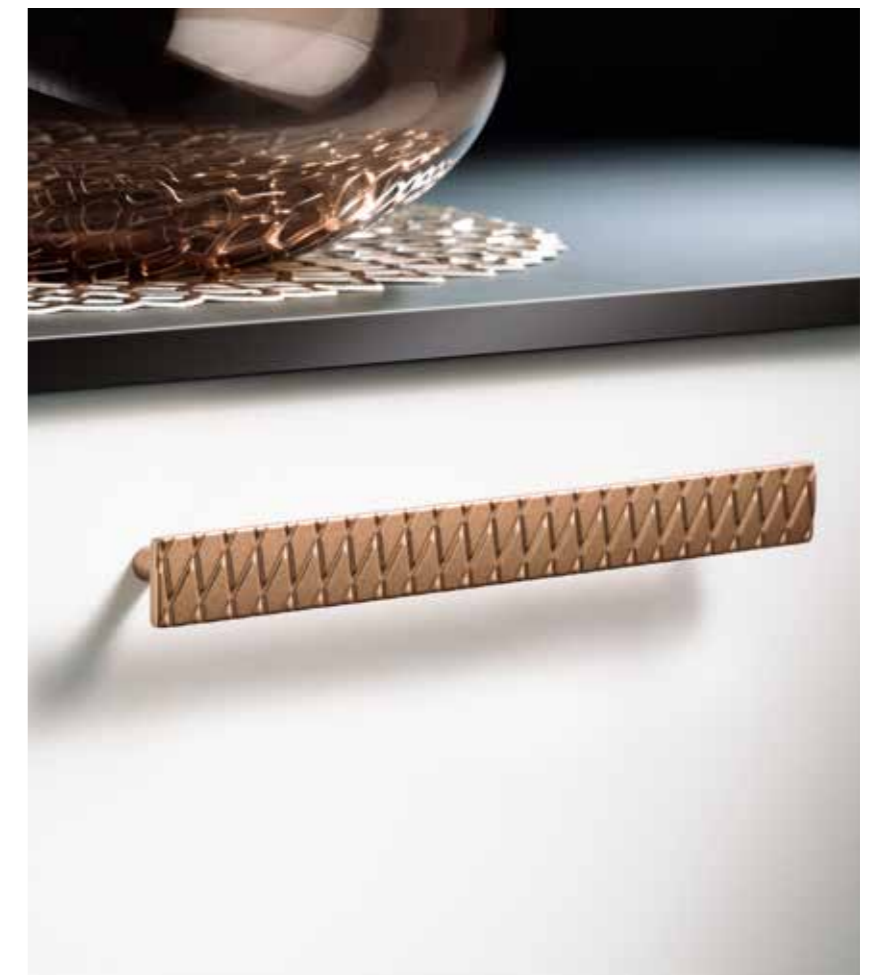
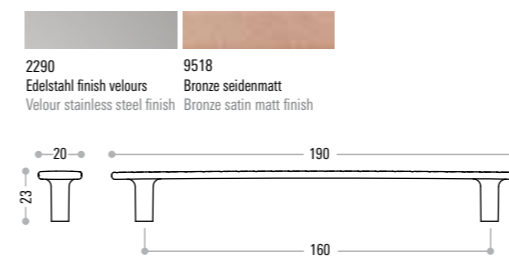



Die Feinsinnigen  
The subtle approach



# Trend Slim-Line



Schlank ist elegant. Durchdachte Konzepte, kein Schnickschnack, sondern ausgewogene Linienführungen stehen bei der Slim-Line-Kollektion im Fokus. Die konsequente Geradlinigkeit verleiht jeder Möbelfront eine besonders elegante Note.

Slimline stands for elegance. The no-frills Slim-Line collection focuses on carefully considered concepts and balanced lines. The consistent, straight lines lend every piece of furniture a particular air of refinement.



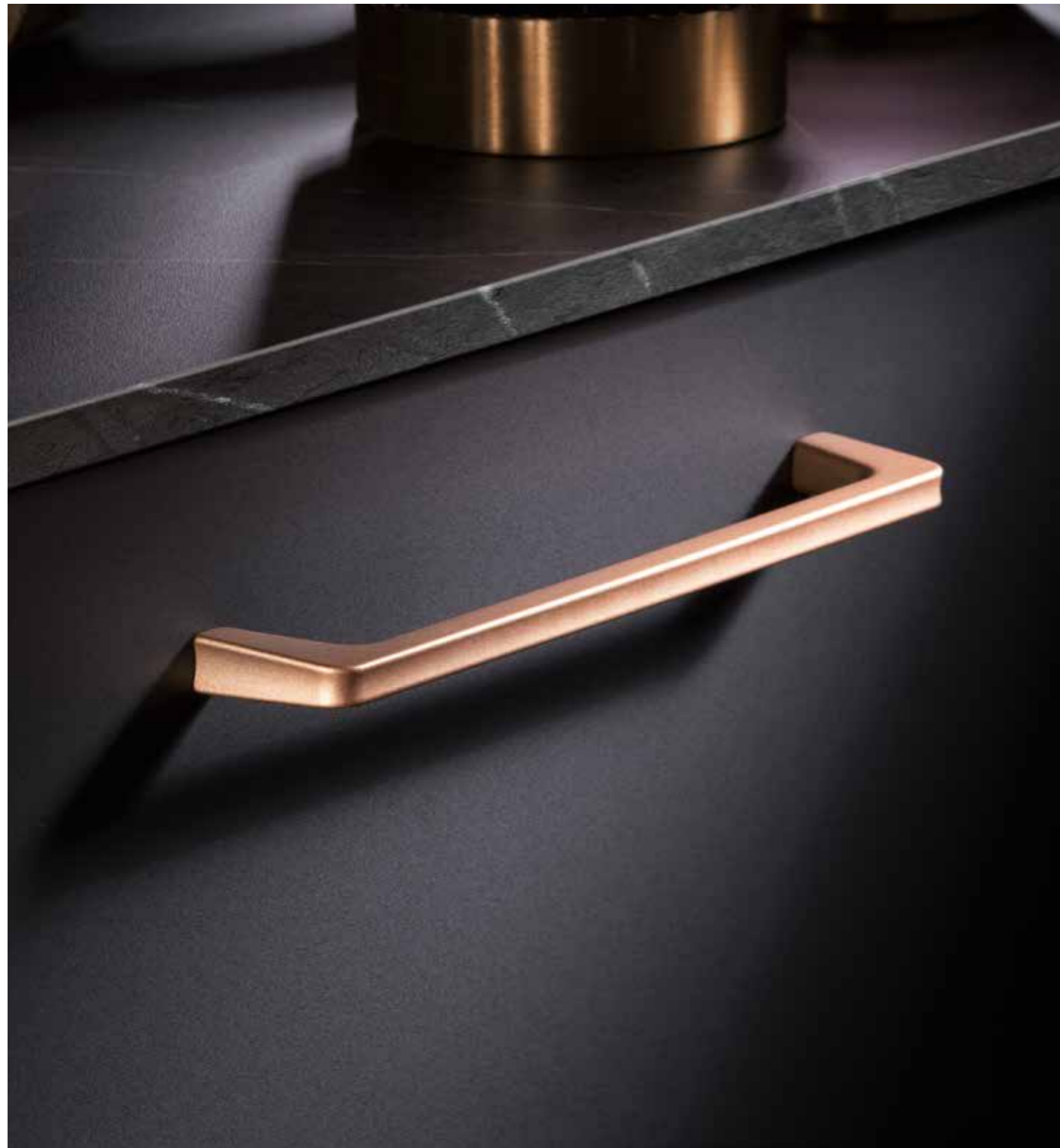

Art.-Nr. 040 036 KEVA

2290 Edelstahl finish velours Velour stainless steel finish	9512 Schwarz matt Matt black

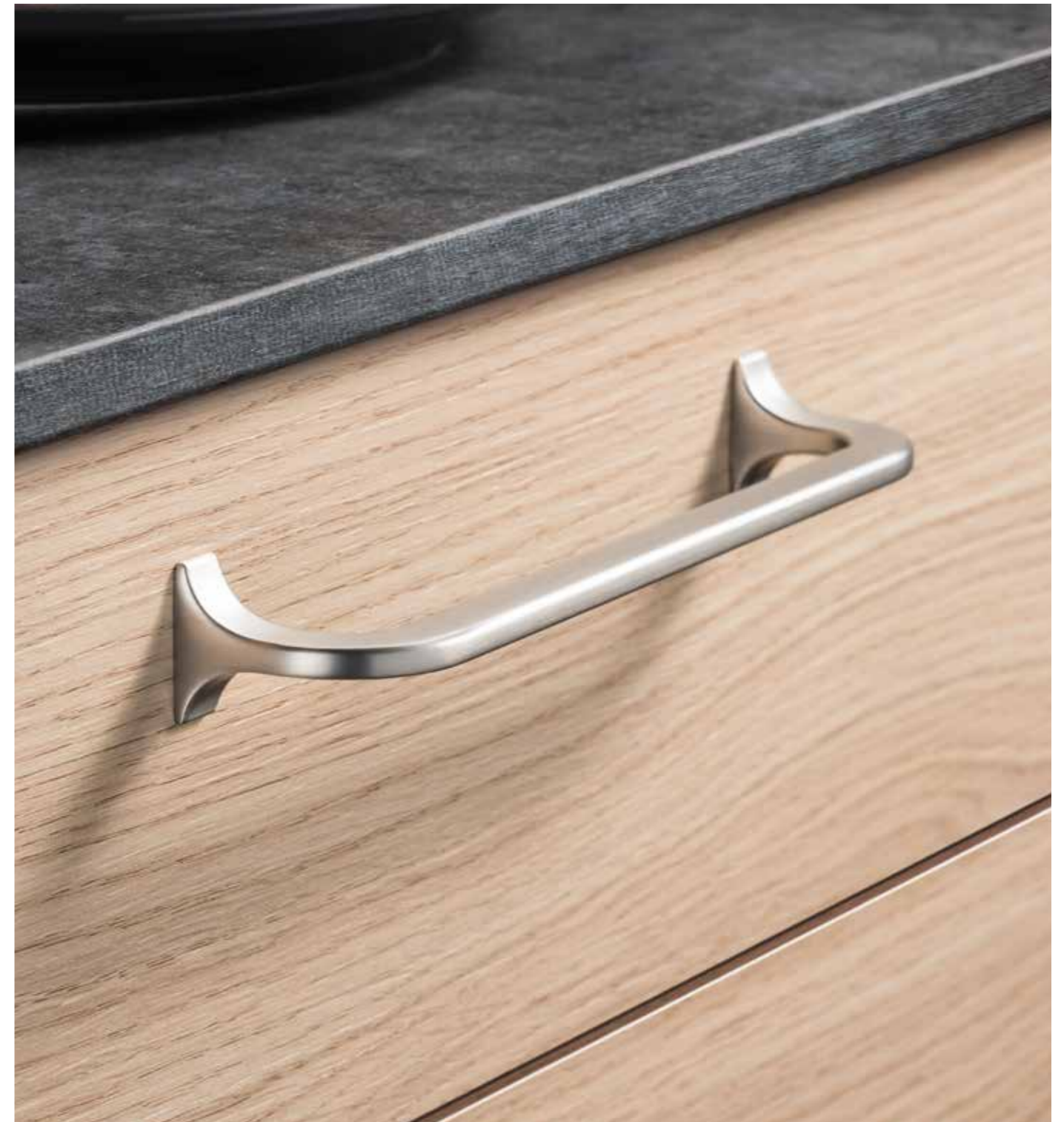
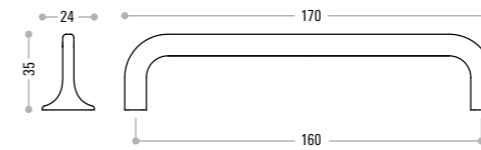

Art.-Nr. 040 040 PRIGOT

2290 Edelstahl finish velours Velour stainless steel finish	9518 Bronze seidenmatt Bronze satin matt finish

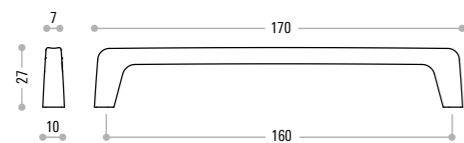



Die dritte Dimension  
The third dimension



# Trend Formation

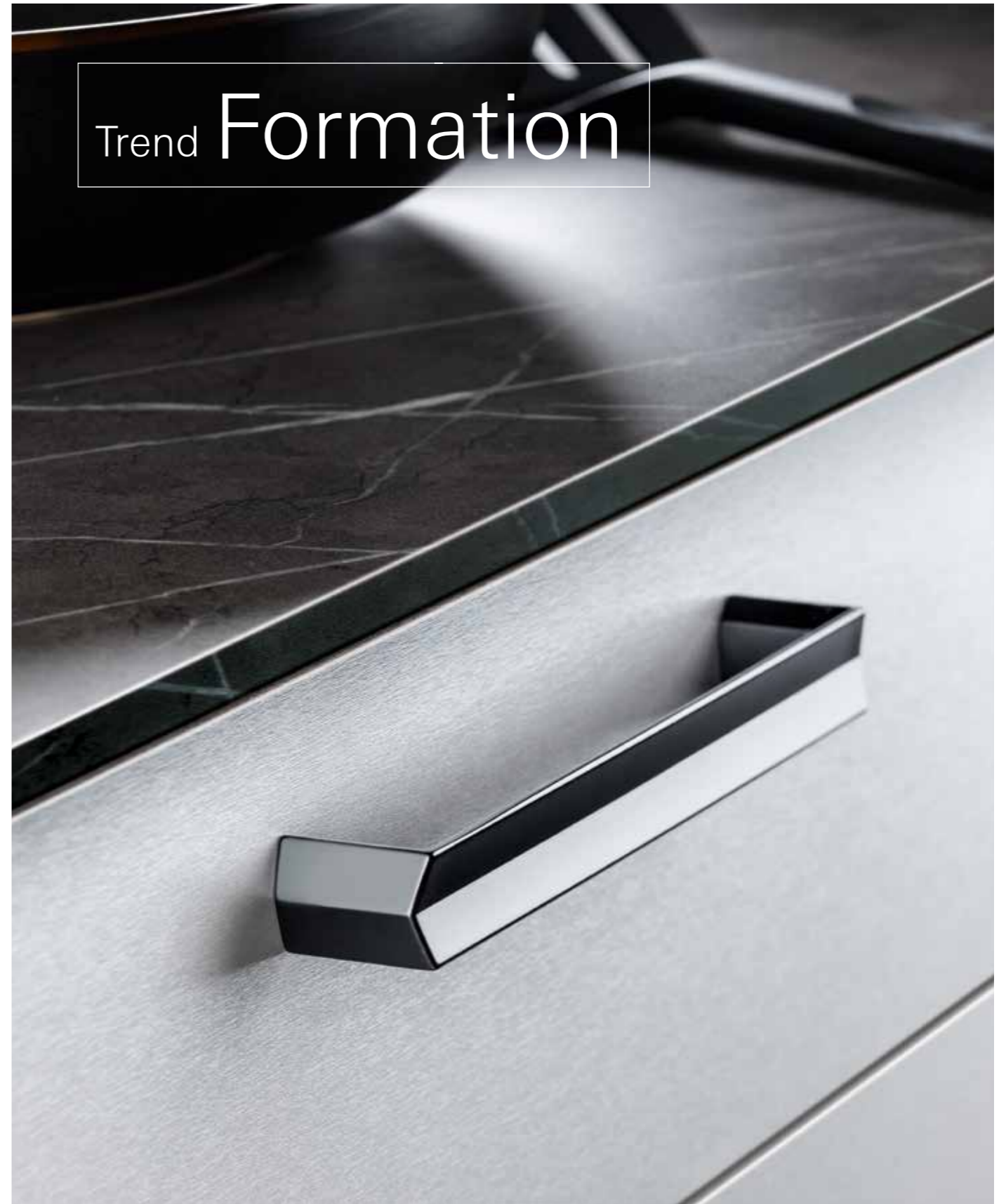

Die Kunst der Formensprache liegt in der gekonnten Kombination verschiedener Flächen, Linien und Geometrien, die sich mit ausgefallenen Strukturen zu einem harmonischen Ganzen vereinen. Überraschend und außergewöhnlich in der Optik überzeugen die Griffe als echte Handschmeichler.

The art of spatial design lies in skilfully combining different areas, lines and geometries with unusual structures which unite to create a harmonious whole. Surprising and unusual in their appearance, the handles are a real pleasure to touch.





Art.-Nr. 040 029 PAO

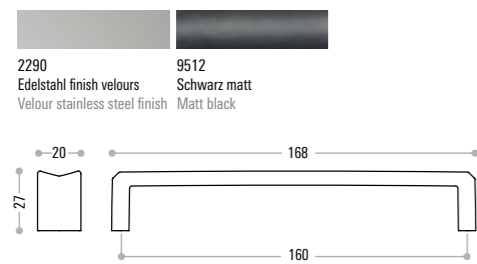

Art.-Nr. 040 034 CESCO

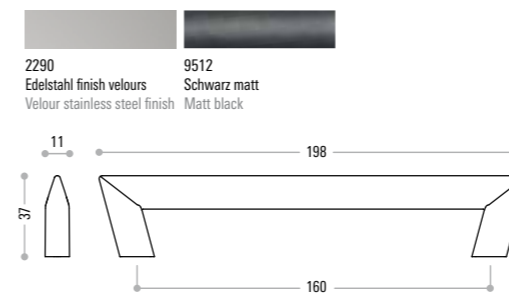



Das gewisse Etwas  
That certain something

# Trend Different

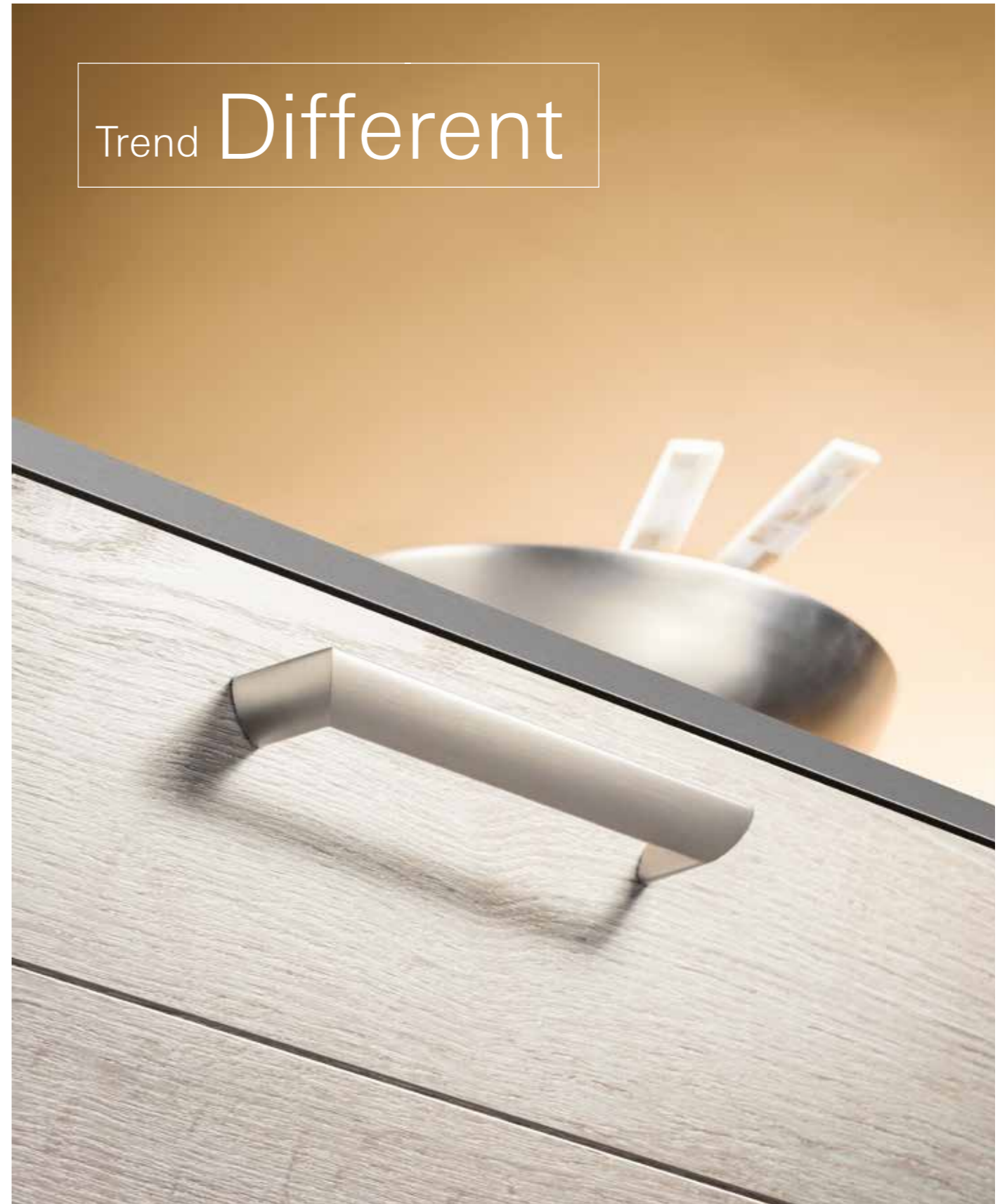

Selbstbewusst bis übermütig wurden Fantasie und Kreativität freier Lauf gelassen. Bei der Umsetzung kommen die technischen Faktoren ins Spiel. Ergebnis sind Griffe, die überraschend anders und gleichzeitig höchst anpassungsfähig sind.

From confident to exuberant, fantasy and creativity have been given free reign, while technical factors come in to play in the implementation. This results in handles that are both drastically different and still easily adaptable.





Art.-Nr. 040 043 BIKO

2290 Edelstahl finish velours  
Velour stainless steel finish

9512 Schwarz matt  
Matt black

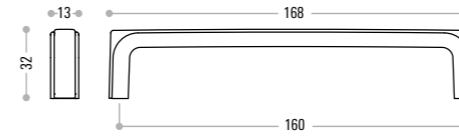

Art.-Nr. 040 035 BIATO

2290 Edelstahl finish velours  
Velour stainless steel finish

9512 Schwarz matt  
Matt black

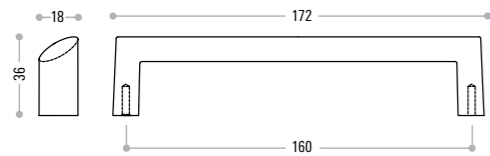



Eine Frage des Stils  
A question of style

# Kollektion

Collection



Eine Kollektion so vielseitig wie jeder einzelne Griff. Schlicht und elegant lässt er der Möbelfront den Vortritt. Ausdrucksstark und markant setzt er gezielt Akzente. Harmonisch ergänzt er den Stil seiner Umgebung. Den Einsatzbereichen sind keine Grenzen gesetzt.

A collection as diverse as the handles themselves. Simple and elegant, each handle allows the furniture to take centre stage. Expressive and striking, they deliberately convey character and harmoniously complement the style of their surroundings. There are no limits to how the handles can be used.





SANTIО

**Art.-Nr. 040 021 SANTIО**

2290	9512	9603	9502
Edelstahl finish velours	Schwarz matt	Chrom glänzend	Rotgold finish velours
Velour stainless steel finish	Matt black	Glossy chrome	Velour rose gold finish

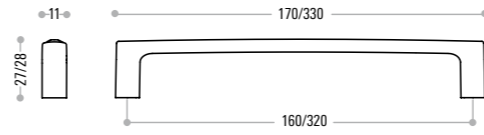

BLIC

**Art.-Nr. 040 024 BLIC**

2290	9512
Edelstahl finish velours	Schwarz matt
Velour stainless steel finish	Matt black

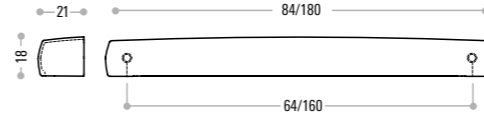

QUEN

**Art.-Nr. 040 023 QUEN**

9512	9514
Schwarz matt	Anthrazit matt
Matt black	Matt anthracite

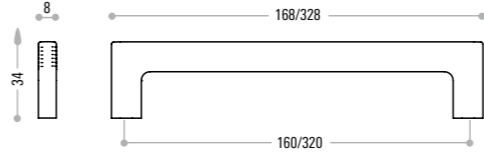

BALIAN

**Art.-Nr. 040 020 BALIAN**

2290	9512	9514
Edelstahl finish velours	Schwarz matt	Anthrazit matt
Velour stainless steel finish	Matt black	Matt anthracite

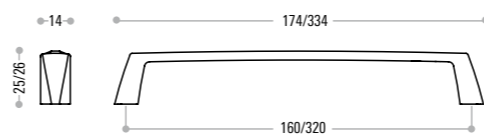

PAROL

**Art.-Nr. 040 022 PAROL**

9512	9502
Schwarz matt	Rotgold finish velours
Matt black	Velour rose gold finish

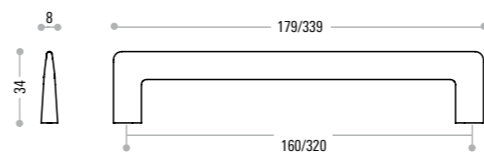





CALLISTRA



STANZIA



PATER



CARRY

**Art.-Nr. 040 027 CALLISTRA**

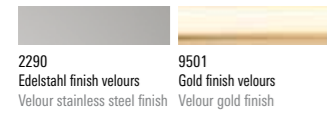

2290 Edelstahl finish velours  
Velour stainless steel finish

9501 Gold finish velours  
Velour gold finish

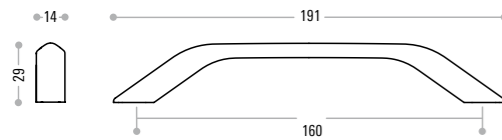

**Art.-Nr. 040 026 STANZIA**

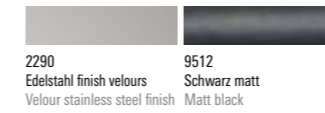

2290 Edelstahl finish velours  
Velour stainless steel finish

9512 Schwarz matt  
Matt black

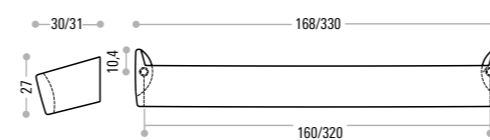

**Art.-Nr. 040 025 PATER**



2290 Edelstahl finish velours  
Velour stainless steel finish

9512 Schwarz matt  
Matt black

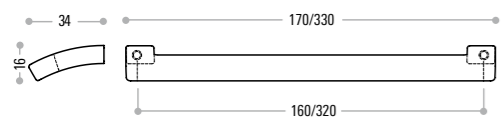

**Art.-Nr. 040 005 CARRY**

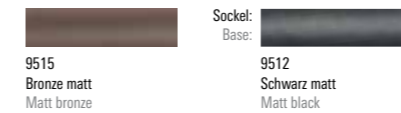

9515 Bronze matt  
Matt bronze

9512 Schwarz matt  
Matt black

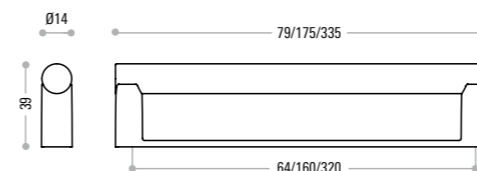





LEVEL

**Art.-Nr. 040 004 LEVEL**

2290 9514  
Edelstahl finish velours Anthrazit matt  
Velour stainless steel finish Matt anthracite

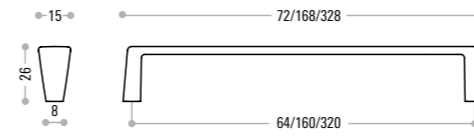

CLUB

**Art.-Nr. 040 000 CLUB**

2290 9512  
Edelstahl finish velours Schwarz matt  
Velour stainless steel finish Matt black

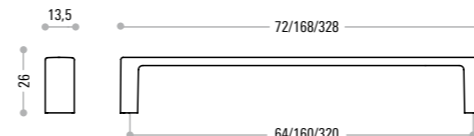

FACETTE

**Art.-Nr. 040 011 FACETTE**

2290  
Edelstahl finish velours  
Velour stainless steel finish

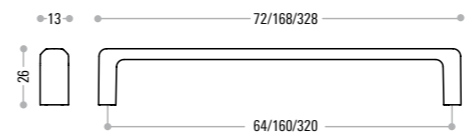

SWING

**Art.-Nr. 040 001 SWING**

2290 9513  
Edelstahl finish velours Messing matt  
Velour stainless steel finish Matt brass

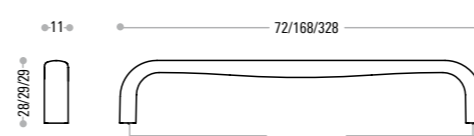



CURVE

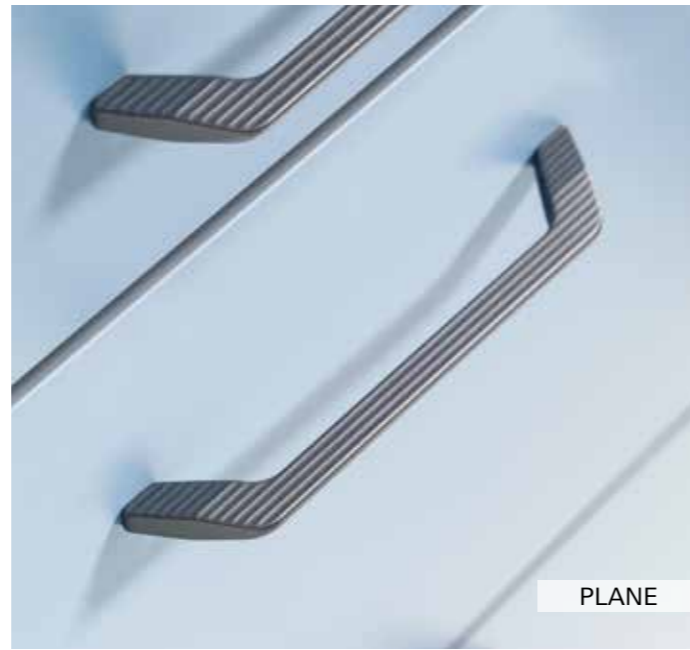

PLANE



STRIPE



RIFFLE

**Art.-Nr. 040 002 CURVE**

2290 Edelstahl finish velours  
Velour stainless steel finish

9512 Schwarz matt  
Matt black

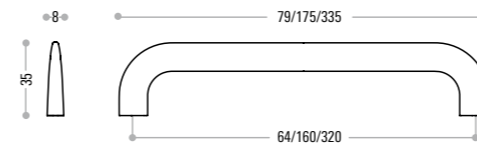

**Art.-Nr. 040 003 PLANE**

9514 Anthrazit matt  
Matt anthracite

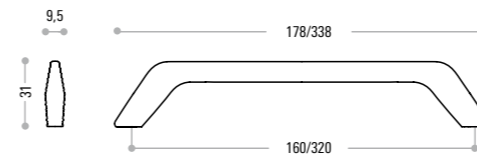

**Art.-Nr. 040 009 STRIPE**

2295 Edelstahl finish eloxiert  
Anodised stainless steel finish

9514 Anthrazit matt  
Matt anthracite

9612 Schwarz eloxiert  
Anodised black

9613 Natur eloxiert  
Natural anodised

Socket:  
Base:

2295 Edelstahl finish eloxiert  
Anodised stainless steel finish

9514 Anthrazit matt  
Matt anthracite

9612 Schwarz eloxiert  
Anodised black

9613 Natur eloxiert  
Natural anodised

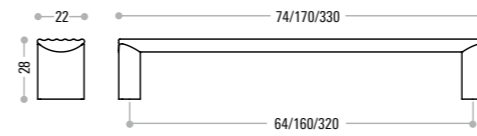

**Art.-Nr. 040 007 RIFFLE**

2298 Edelstahl finish brüniert  
Bronzed stainless steel finish

9512 Schwarz matt  
Matt black

9512 Schwarz matt  
Matt black

Socket:  
Base:

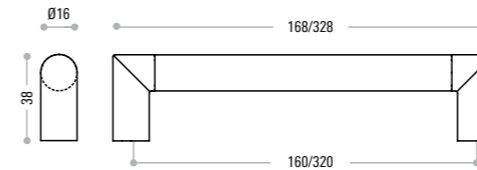

**Art.-Nr. 040 010 LINE**

9514 Anthrazit matt  
Matt anthracite

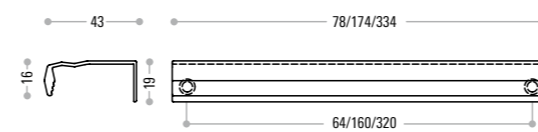





**Art.-Nr. 030 016**

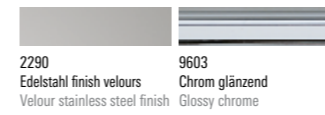

2290 Edelstahl finish velours  
Velour stainless steel finish

9603 Chrom glänzend  
Glossy chrome

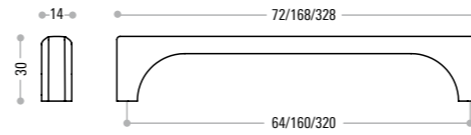

**Art.-Nr. 030 011**



2290 Edelstahl finish velours  
Velour stainless steel finish

9603 Chrom glänzend  
Glossy chrome

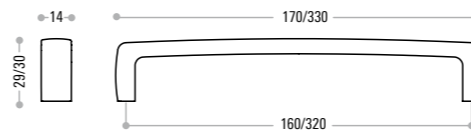

**Art.-Nr. 030 017**



6572 Gunmetal gerändelt  
Knurled gun metal

9005 Edelstahl gerändelt  
Knurled stainless steel

0020 Nickel glänzend  
Nickel shiny

2290 Edelstahl finish velours  
Velour stainless steel finish

9007 Black Edition  
Black edition

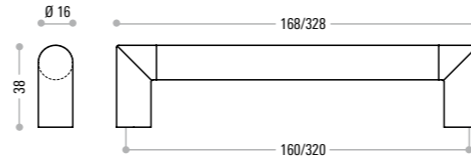

**Art.-Nr. 030 010**



9510 Anthrazit lackiert  
Lacquered anthracite

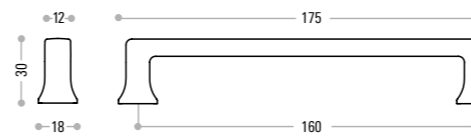

**Art.-Nr. 030 005**

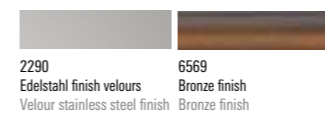

2290 Edelstahl finish velours  
Velour stainless steel finish

6569 Bronze finish  
Bronze finish



**Art.-Nr. 017 882**

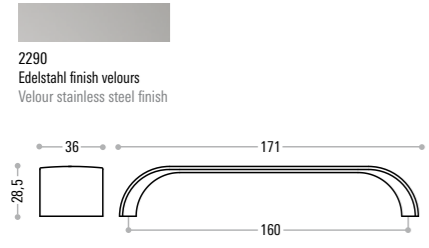

2290  
Edelstahl finish velours  
Velour stainless steel finish



**Art.-Nr. 017 931**

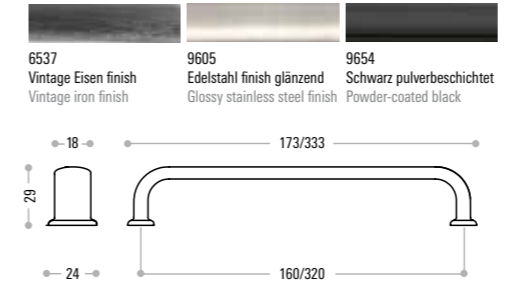

6537 Vintage Eisen finish  
Vintage iron finish

9605 Edelstahl finish glänzend  
Glossy stainless steel finish

9654 Schwarz pulverbeschichtet  
Powder-coated black



**Art.-Nr. 017 728**



2290 Edelstahl finish velours  
Velour stainless steel finish

6550 Antik Zink finish  
Antique zinc finish

9605 Edelstahl finish glänzend  
Glossy stainless steel finish



**Art.-Nr. 017 938**



9603 Chrom glänzend  
Glossy chrome

9605 Edelstahl finish glänzend  
Glossy stainless steel finish

9619 Schwarz lackiert velours  
Lacquered black velour

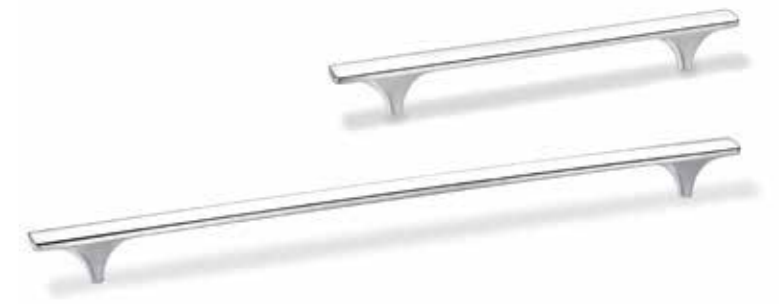

**Art.-Nr. 030 004**

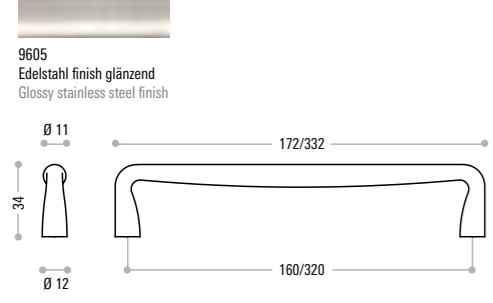

9605  
Edelstahl finish glänzend  
Glossy stainless steel finish



**Art.-Nr. 017 829**

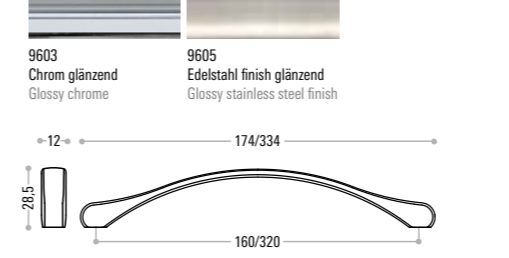

9603 Chrom glänzend  
Glossy chrome

9605 Edelstahl finish glänzend  
Glossy stainless steel finish



**Art.-Nr. 017 902**

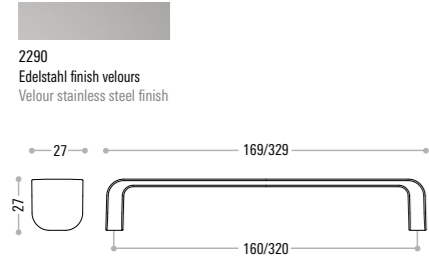

2290  
Edelstahl finish velours  
Velour stainless steel finish



**Art.-Nr. 017 841**

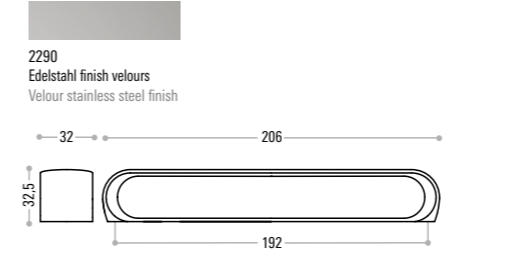

2290  
Edelstahl finish velours  
Velour stainless steel finish



**Art.-Nr. 030 000**

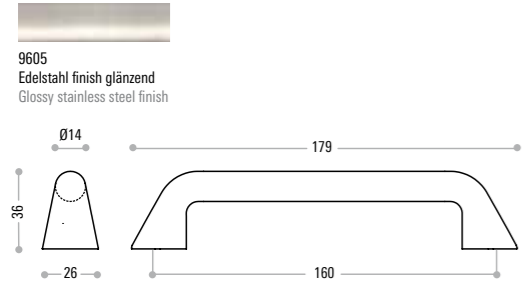

9605  
Edelstahl finish glänzend  
Glossy stainless steel finish



**Art.-Nr. 017 880**



9603 Chrom glänzend  
Glossy chrome

9605 Edelstahl finish glänzend  
Glossy stainless steel finish

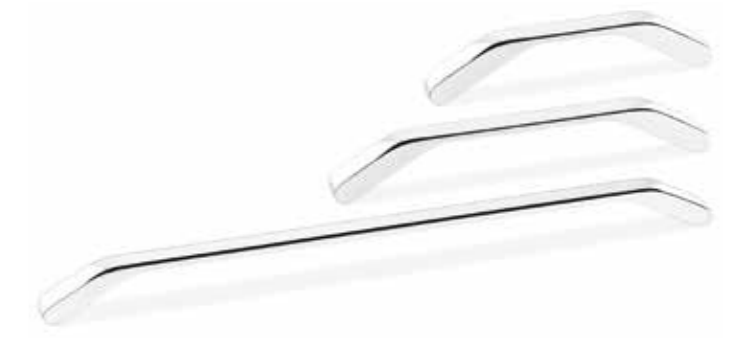





**Art.-Nr. 030 009**



9603  
Chrom glänzend  
Glossy chrome

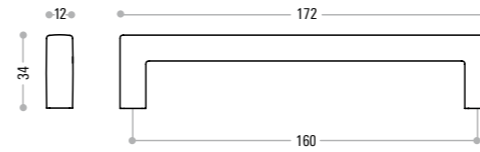

**Art.-Nr. 017 535**



9605  
Edelstahl finish glänzend  
Glossy stainless steel finish

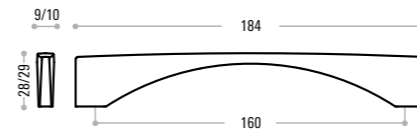

**Art.-Nr. 017 649**



9603 Chrom glänzend Glossy chrome  
9605 Edelstahl finish glänzend Glossy stainless steel finish

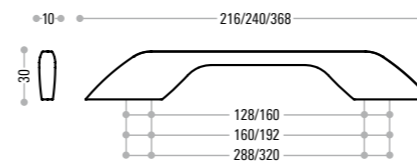

**Art.-Nr. 017 687**



2290 Edelstahl finish velours Velour stainless steel finish  
6550 Antik Zink finish Antique zinc finish  
9605 Edelstahl finish glänzend Glossy stainless steel finish

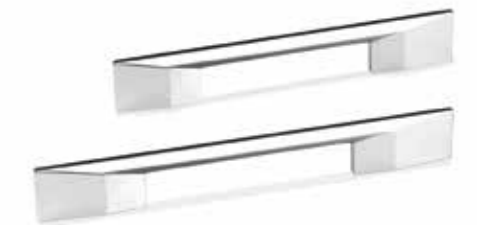
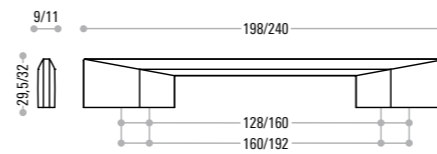

**Art.-Nr. 017 683**



2290 Edelstahl finish velours Velour stainless steel finish  
9603 Chrom glänzend Glossy chrome  
9605 Edelstahl finish glänzend Glossy stainless steel finish

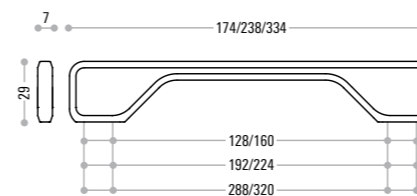

**Art.-Nr. 017 685**

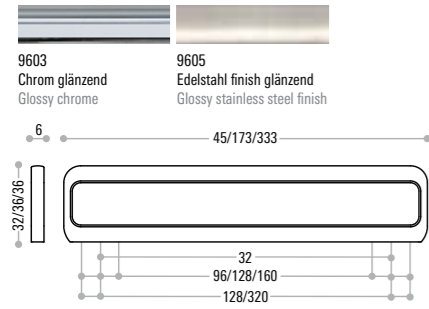

**Art.-Nr. 017 020**

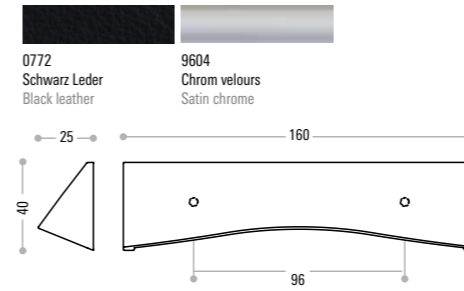

**Art.-Nr. 017 727**

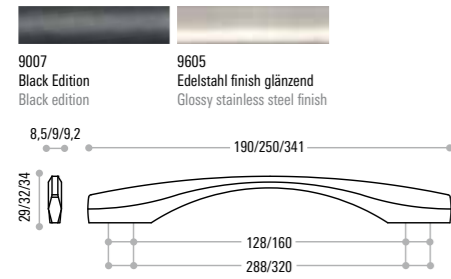

**Art.-Nr. 017 803**

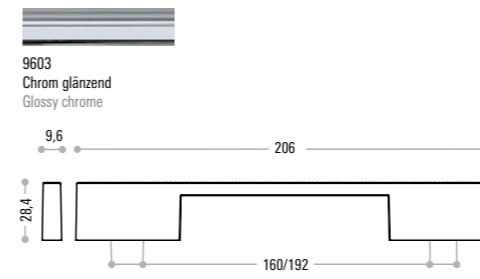

**Art.-Nr. 017 650**

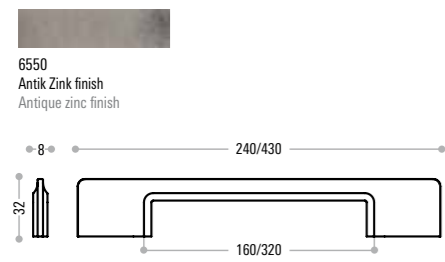

**Art.-Nr. 017 014**

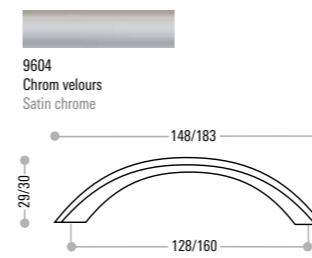

**Art.-Nr. 017 241**

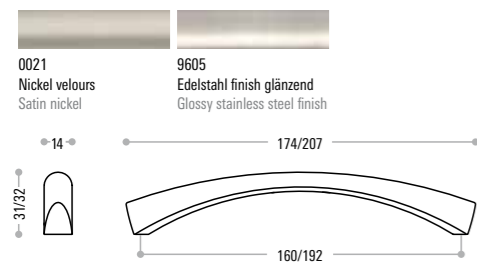

**Art.-Nr. 016 450**

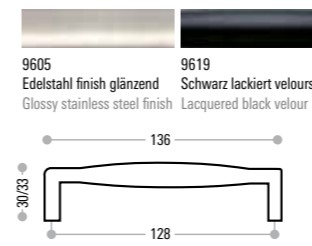

**Art.-Nr. 017 096**

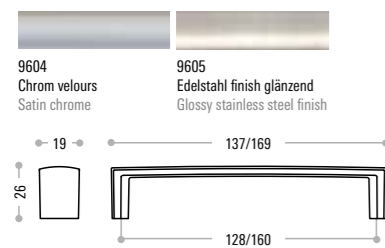

**Art.-Nr. 016 338**

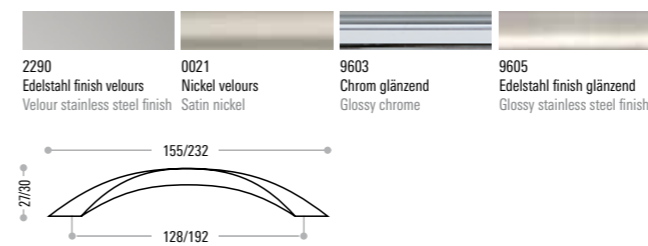



**Art.-Nr. 017 359**

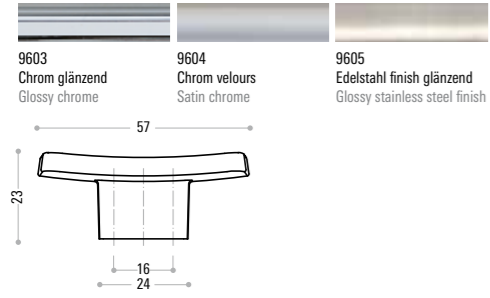

**Art.-Nr. 017 800**

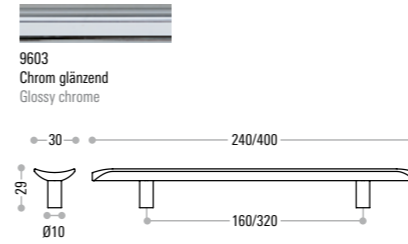

**Art.-Nr. 017 357**

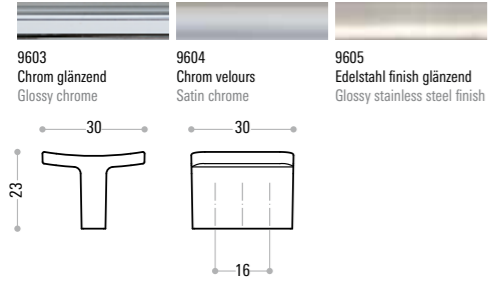

**Art.-Nr. 017 507**

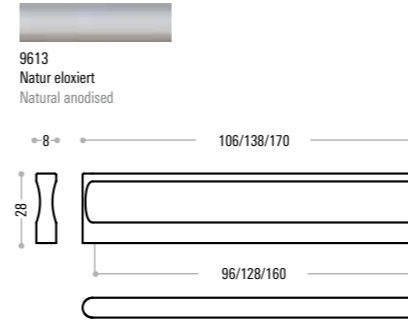

**Art.-Nr. 016 958**

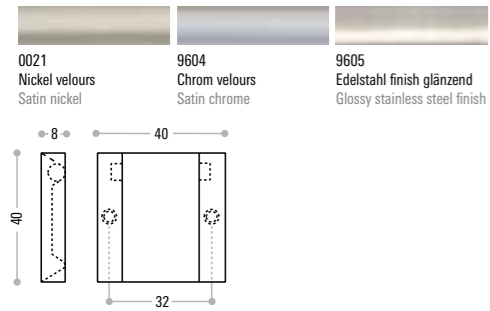

**Art.-Nr. 017 018**

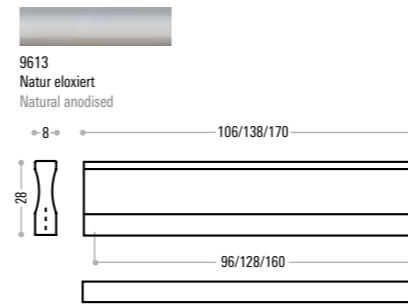

**Art.-Nr. 017 021**

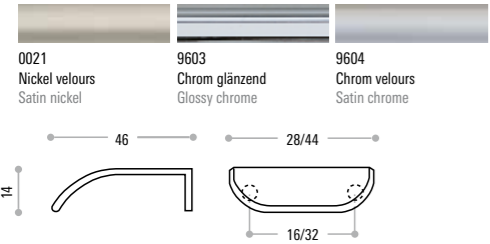

**Art.-Nr. 017 754**

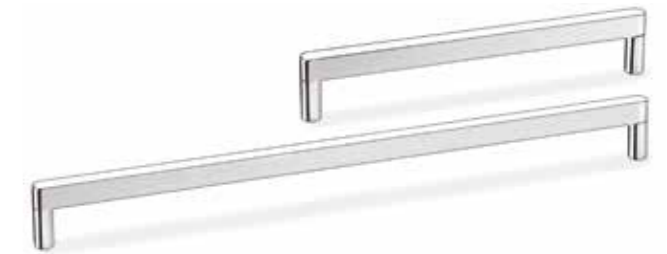
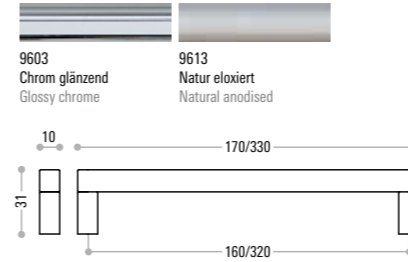

**Art.-Nr. 017 968**

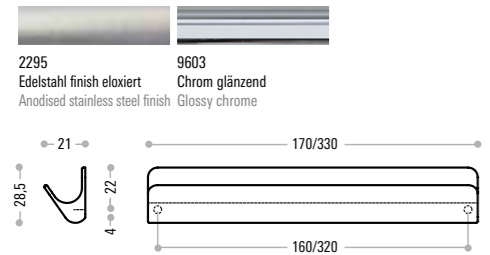

**Art.-Nr. 017 760**

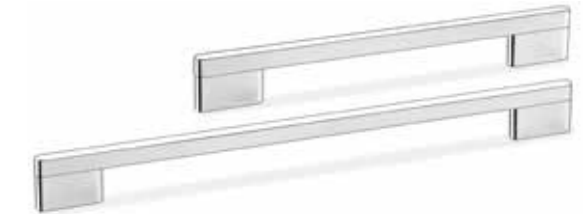
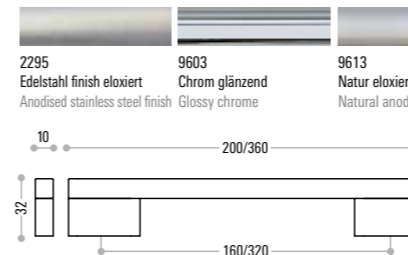



**Art.-Nr. 030 001**



9619 Schwarz lackiert velours  
Lacquered black velours

6521 Giacometti Texture  
Giacometti texture

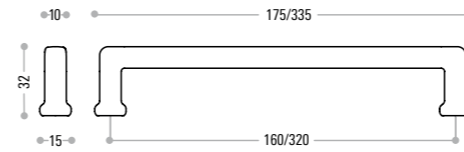

**Art.-Nr. 017 964**



6545 Carving antik Eisen finish  
Antique iron carving finish

6557 Carving Eisen dunkel finish  
Dark iron carving finish

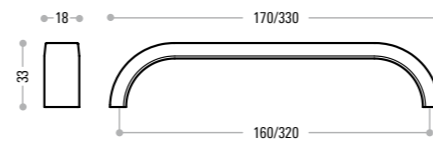

**Art.-Nr. 017 884**



6545 Carving antik Eisen finish  
Antique iron carving finish

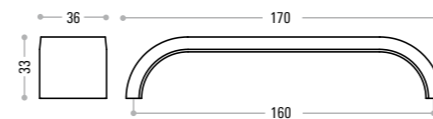

**Art.-Nr. 017 939**



6538 Flechtwerk  
Wickerwork

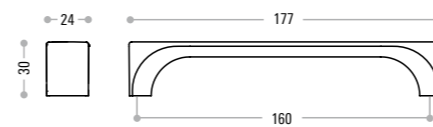

**Art.-Nr. 017 895**



6536 Antik Eisen finish  
Antique iron finish

9619 Schwarz lackiert velours  
Lacquered black velours

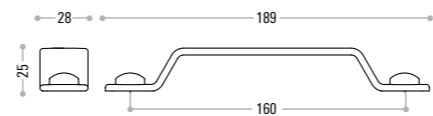



**Art.-Nr. 017 973**

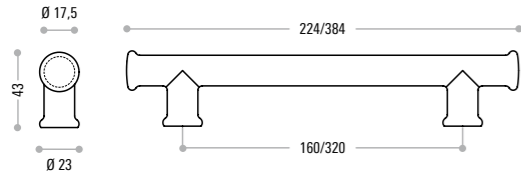
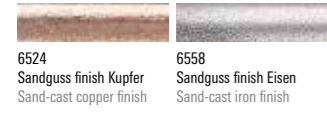

**Art.-Nr. 017 811**

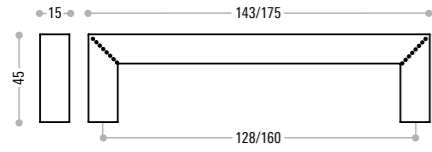

**Art.-Nr. 017 812**

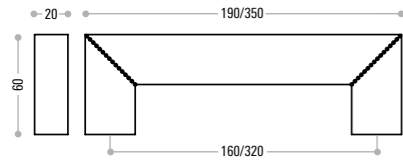
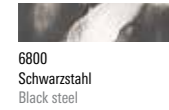

**Art.-Nr. 017 773**

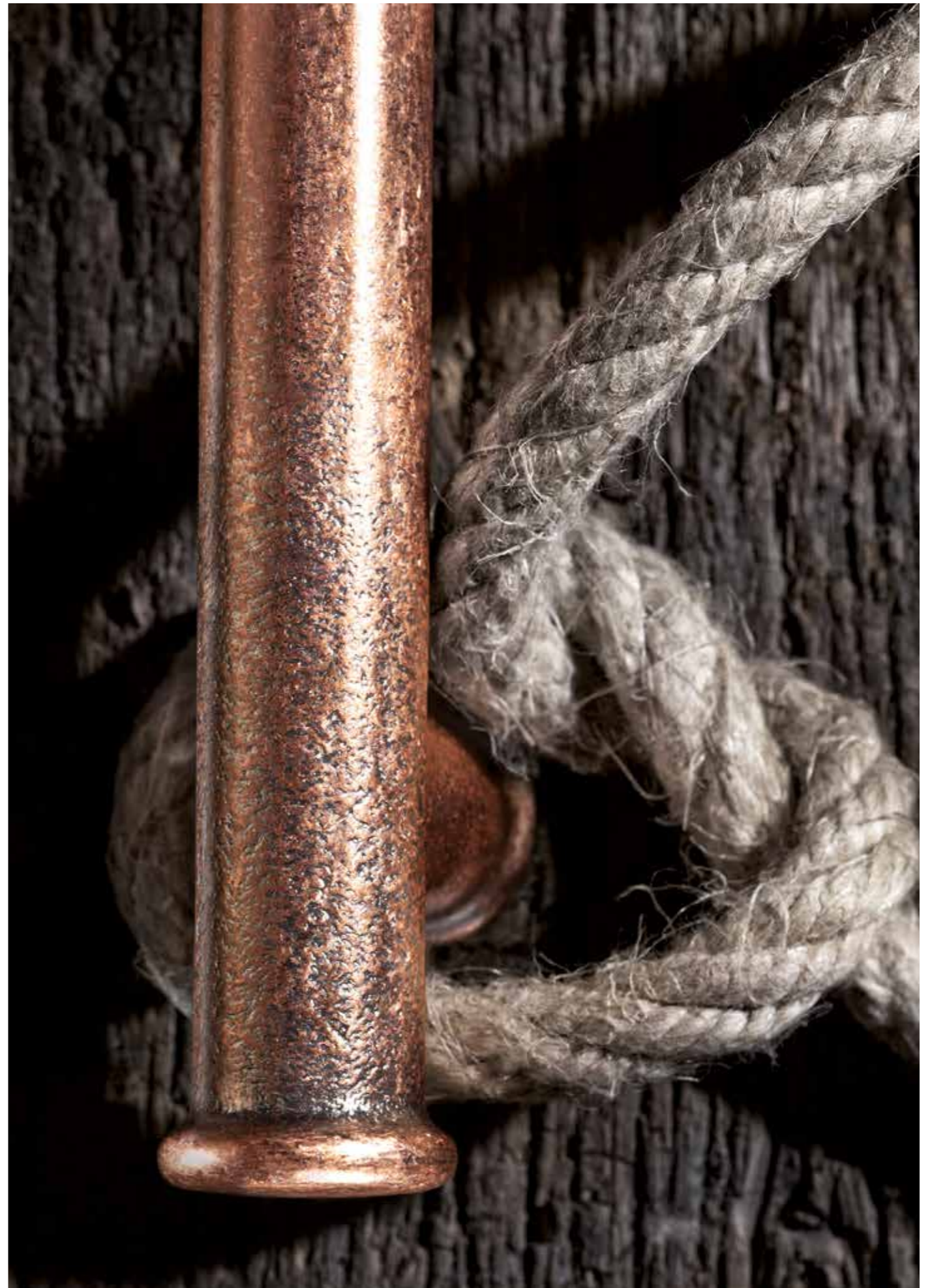
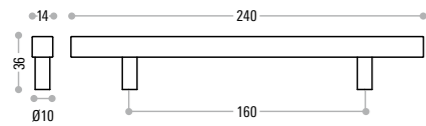

**Art.-Nr. 017 935**

9603 Chrom glänzend  
Glossy chrome

9605 Edelstahl finish glänzend  
Glossy stainless steel finish

Dekor:  
Decor:

2010 2011 2015

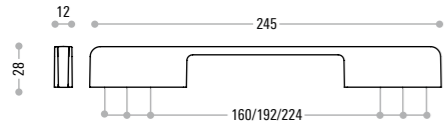

**Art.-Nr. 017 804**

9603 Chrom glänzend  
Glossy chrome

Dekor:  
Decor:

6620

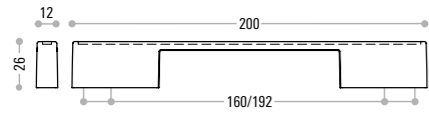

**Art.-Nr. 017 579**

9603 Chrom glänzend  
Glossy chrome

Dekor:  
Decor:

2010 2011

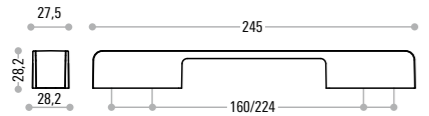

**Art.-Nr. 017 794**

9612 Schwarz eloxiert  
Anodised black

9603 Chrom glänzend  
Glossy chrome

Socket:  
Base:

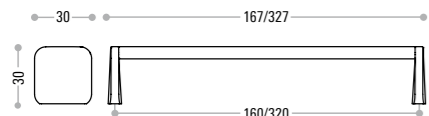

**Art.-Nr. 017 370**

Korpus:  
Body:

0519 Eiche hell  
Light oak

3001 Erle  
Alder

9627 Buche natur lackiert  
Natural laquered beech

Socket:  
Base:

0021 Nickel velours  
Satin nickel

9604 Chrom velours  
Satin chrome

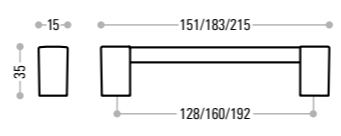

**Art.-Nr. 017 175**

Korpus:  
Body:

0240 Dunkelbraun Leder  
Dark brown leather

Socket:  
Base:

2290 Edelstahl finish velours  
Velour stainless steel finish

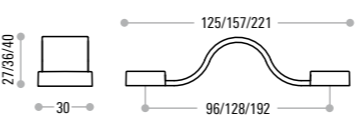

**Art.-Nr. 017 161**

0240 Dunkelbraun Leder  
Dark brown leather

Socket:  
Base:

2290 Edelstahl finish velours  
Velour stainless steel finish

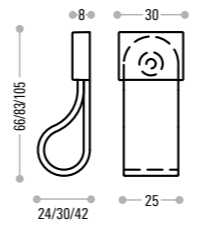



# Auf einen Blick At a glance

## Trends

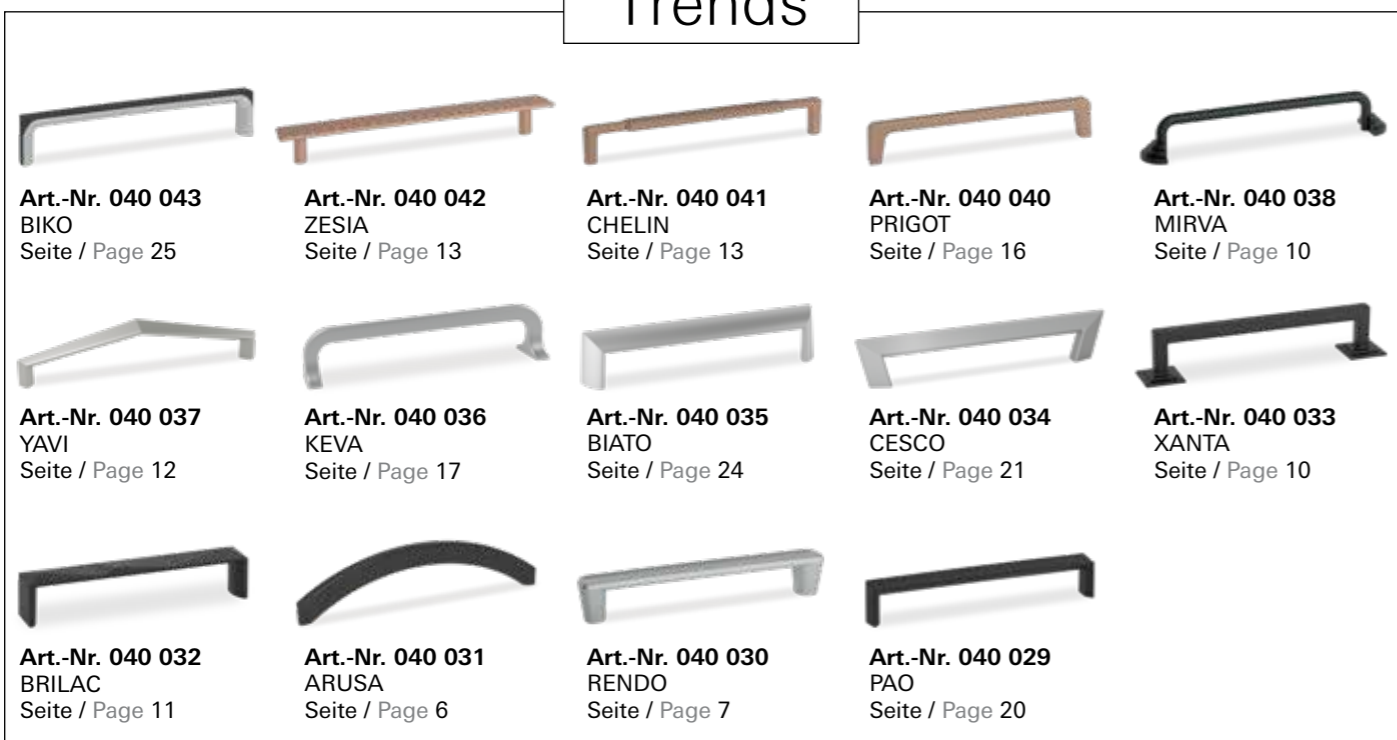

Unsere Kollektion bietet viele Möglichkeiten und Varianten hinsichtlich Design, Farben, Größen und Kombinationen. Viele von diesen trendorientierten Griffen sind als Lagerprogramm erhältlich und somit kurzfristig ab Lager lieferbar.

Ihr Gebietsmanager informiert Sie gern über die Lagerverfügbarkeiten, Größen, Abnahmemengen etc.. Viele unserer Kollektionsartikel, Farben oder Größen können für Sie auftragsbezogen produziert werden. Wir beraten Sie gerne über Mindestbestellmengen, Lieferzeiten oder verfügbare Bestände.

**Pflegehinweis:**

Bitte verwenden Sie nur lösungsmittelfreie Reinigungsmittel.

Our collection offers many different possibilities and options when it comes to design, colour, size and combinations. Many of these trend-oriented handles are available as stock items and can therefore be delivered ex stock at short notice.

Your area sales manager will be happy to give you more information about stock availability, sizes, purchase quantities, etc. Many of our collection articles, colours and sizes can be produced for you on an order-specific basis. We will be happy to advise you about minimum order quantities, delivery times and available stocks.

**Maintenance instructions:**

Please use solvent-free cleaning agents only.

P4459/04.22/Printed in Germany.

Änderungen und Irrtümer vorbehalten. Abbildungen ähnlich. Die Zeichen „Schüco“ und andere sind in Deutschland und diversen internationalen Märkten geschützt. Auf Nachfrage erteilen wir detaillierte Auskunft.

P4459/03.22/Printed in Germany.

We reserve the right to make changes and to correct errors. Pictures shown are for illustrative purposes only. The “Schüco” logo and other logos are protected in Germany and various international markets. Detailed information is available on request.



# Stil und Zeitgeist im Einklang

## Style and Zeitgeist in harmony



Die Kollektion der Schüco Interior Systems Designgriffe präsentiert sich so vielseitig wie jeder einzelne Griff. Das Neuheiten-Programm spiegelt aktuelle Designtrends wider – von schlichter Eleganz bis zu facettenreichen Formen. Der Standardbereich ist alles andere als Standard. Optik, Funktionalität und Qualität sind im Einklang, die Einsatzbereiche unbegrenzt, das Design ist vielfältig und ausgewogen – für jeden Stil, für jeden Lebensraum der passende Griff.

### **70 Jahre Schüco – Systemlösungen für Fenster, Türen und Fassaden**

Die Schüco Gruppe mit Hauptsitz in Bielefeld entwickelt und vertreibt Systemlösungen für Fenster, Türen und Fassaden. Mit weltweit 5.650 Mitarbeitenden arbeitet das Unternehmen daran, heute und in Zukunft Technologie- und Serviceführer der Branche zu sein. Neben innovativen Produkten für Wohn- und Arbeitsgebäude bietet der Gebäudehüllenspezialist Beratung und digitale Lösungen für alle Phasen eines Bauprojektes – von der initialen Idee über die Planung und Fertigung bis hin zur Montage. 12.000 Architekturbüros, Handwerksbetriebe und Bauschaffende, die den Bau eines Gebäudes in Auftrag geben, arbeiten weltweit mit Schüco zusammen. 1951 gegründet, ist das Unternehmen heute in mehr als 80 Ländern aktiv und hat in 2020 einen Jahresumsatz von 1,695 Milliarden Euro erwirtschaftet. Weitere Informationen unter [www.schueco.de](http://www.schueco.de)

The Schüco Interior Systems collection of design handles is as diverse as the handles themselves. The new range reflects the latest design trends – from simple elegance to multi-faceted shapes. The standard range is anything but standard. Appearance, functionality and quality are in harmony, there are no limits to how the handles can be used, and the design is diverse and balanced – the perfect handle for every style, in every living space.

### **70 years of Schüco – System solutions for windows, doors and façades**

Based in Bielefeld, the Schüco Group develops and sells system solutions for windows, doors and façades. With 5650 employees worldwide, the company strives to be the industry leader in terms of technology and service both now and in the future. In addition to innovative products for residential and commercial buildings, the building envelope specialist offers consultation and digital solutions for all phases of a building project – from the initial idea through to design, fabrication and installation. Schüco works with 12,000 architectural practices, fabricators and construction professionals who commission buildings around the world. Founded in 1951, the company is now active in more than 80 countries and achieved a turnover of 1.695 billion euros in 2020. For more information, visit [www.schueco.com](http://www.schueco.com)

# SCHÜCO

### **Schüco Interior Systems KG**

Werk Borgholzhausen

In der Lake 2, D-33829 Borgholzhausen, Tel. +49 5425 12-0, Fax +49 5425 12-236

[interior-systems@schueco.com](mailto:interior-systems@schueco.com), [www.schueco.com/interior-systems](http://www.schueco.com/interior-systems)