

Doc. No. 10000436501_01_de / 02.2016

Aluminium systems

Schüco DCS Touch Display

Commissioning instructions **en**

en **00 Commissioning instructions**

Contents

8	1. Notes on this document
8	1.1. Target groups and qualifications
8	1.2. Handover of the document
8	1.3. Retention of the document
9	2. Security
9	2.1. About the safety instructions
9	2.2. Laws, regulations and technical rules
10	2.3. Proper use
11	2.4. General safety instructions
12	3. Contents of delivery, transportation and storage
12	3.1. Contents of delivery for Schüco DCS Touch Display
12	3.2. Contents of delivery for Schüco IP secure connector
12	3.3. Transportation and storage
13	4. Technical data
13	4.1. Schüco DCS Touch Display
15	4.2. Schüco IP secure connector
16	5. System overview
16	5.1. Overview of system components
17	6. IP secure connector
18	6.1. Overview of IP secure connector
20	6.2. Connections for Schüco IP secure connector
22	6.2.1. Configuration of „OUT2“ on IP secure connector
23	7. DCS Touch Display
24	7.1. Overview of DCS Touch Display
25	7.2. Connections to Schüco DCS Touch Display
26	7.2.1. Connection to lock technology
26	7.2.2. Dismantling
29	8. Screen surface
30	8.1. Start screen
31	8.2. Doorbell list
33	8.2.1. Making a call
34	8.2.2. Ending a call
34	8.3. Entering the access code
37	8.4. Configuration
38	8.4.1. Error messages
39	8.4.2. Network
41	8.4.3. Audio
42	8.4.4. Screen
43	8.4.5. Alarm
44	8.4.6. Language
45	8.4.7. Test
48	8.4.8. Cleaning the display
48	8.4.9. IP secure connector
50	8.4.10. Remote maintenance
51	8.4.11. Close configuration
52	8.5. Aktion auswählen
53	8.6. Symbols

54 9. Web interface

55	9.1. Accessibility
55	9.2. Calling up the web interface
57	9.3. Logging in
58	9.4. Configuration
59	9.5. Message boxes
60	9.6. Overview when logged in
62	9.7. Network
64	9.8. SIP
64	9.8.1. SIP settings
65	9.8.2. SIP server
66	9.8.3. SIP connection
67	9.9. Device
67	9.9.1. Device
73	9.9.2. Audio
74	9.9.3. Video
76	9.9.4. Motion detection
78	9.9.5. Buttons
95	9.10. Activity
96	9.10.1. Activities
96	9.10.2. Adding an activity card
97	9.10.3. Editing an activity
98	9.10.4. Creating an activity
102	9.10.5. Preconfigured activities.
103	9.11. Action sequences
104	9.11.1. Action sequences
104	9.11.2. Editing action sequences
106	9.11.3. Actions
108	9.11.4. Creating an action sequence
109	9.11.5. Anti-theft sequence
114	9.11.6. Preconfigured action sequences
117	9.12. Contacts
118	9.12.1. Editing a contact
119	9.12.2. Adding a contact
121	9.12.3. Exporting contacts
122	9.12.4. Kontakte importieren
125	9.12.5. Editing a preconfigured contact
129	9.12.6. Peer-to-Peer
130	9.12.7. Hidden contact
133	9.13. Media
134	9.13.1. Adding an audio file
136	9.13.2. Photos
137	9.14. System
138	9.14.1. System
138	9.14.2. Configuration
139	9.14.3. E-mail settings
139	9.14.4. Exporting the configuration
139	9.14.5. Importing the configuration
143	9.15. User administration
143	9.15.1. Users
144	9.15.2. Profile
146	9.15.3. Roles
147	9.15.4. Editing a role
150	9.15.5. Creating a user
152	9.15.6. Creating a role
155	9.15.7. Changing a password
158	9.15.8. Changing the access code
160	9.16. Codecs

161 9.17. Remote maintenance

162 10. Replacing an IP secure connector

163 11. Faults and troubleshooting

163 12. Care and maintenance

163 13. Decommissioning

164 14. Service and support

1. Notes on this document

1.1. Target groups and qualifications

This document is intended for qualified personnel, such as trained fitters and electricians. Before installing and commissioning, read through this document thoroughly and adhere to the specified sequence of the instructions. Schüco International KG shall not be liable for any damage which arises from a failure to adhere to these instructions.

Qualified personnel are people who know how to assemble, install, commission, test and operate the product and who have the relevant qualifications, e.g. who have been trained and instructed in accordance with safety regulations on the maintenance and use of appropriate safety equipment and who have received training in First Aid.

Experts are people whose training and experience means that they have sufficient knowledge of power-operated windows, doors and gates and the corresponding electrical installations. They are familiar with the relevant accident prevention regulations, government Health & Safety regulations, guidelines and generally recognised technical regulations so that they are qualified to judge the occupational safety of power-operated windows, doors and gates and the corresponding electrical installations.

1.2. Handover of the document

After commissioning, hand over all the documentation pertaining to this product to the end customer. Make them aware of the safety instructions, to which they must pay particular attention.

1.3. Retention of the document

This document is a component of the product. Keep this document in an accessible place even after installation and commissioning, so that the information is always available.

2. Security

2.1. About the safety instructions



KEY WORD

Type / source / consequence of the danger

Pictograms and key words advise of the type of danger and the level of danger:







General
personal injury



Personal injury from
electrocution



Damage to property.

DANGER		Imminent danger resulting in death or severe injuries.
WARNING		Potential imminent danger which may lead to death or severe injuries.
CAUTION		Potentially dangerous situation which may lead to minor injuries.
NOTE		Imminent danger of damage to property which may lead to damage to or destruction of the product or environment.
INFORMATION		Information Information, tips and advice

2.2. Laws, regulations and technical rules

During installation and operation, observe the international, national and local safety regulations, laws and guidelines.

Accepted practice as usually codified in standards, guidelines, specifications and regulations laid down by recognised bodies must be followed.

This applies in particular to:

- European and international standards, e.g. EN 60335-2-103 on the safety of electrical devices
- VDE guidelines and regulations, e.g. DIN VDE 0100, DIN VDE 0160, DIN VDE 0632
- Guidelines and regulations of the professional trade associations, e.g. BGR 232 (previously ZH 1/494) for power-operated windows, doors and gates, BGV A2 (previously VBG4) accident prevention regulations for electrically-operated systems and devices
- Data sheets of the German Association of Window and Façade Manufacturers e.V. (e.g. KB.01 / KB.02 electrically operated windows)

2.3. Proper use

The DCS Touch Display is a modular intercom station that is based on SIP technology (RFC 2327, RFC 2396, RFC 2617, RFC 2833, RFC 2876, RFC 3261, RFC 3310 and RFC 3550).

It is intended for door communication inside and outside as well as for access control.

The DCS Touch Display must be flush-fitted, whereby it is integrated into the existing DCS profile, for example, or alternatively installed on a panel or a wall. In addition to the 4.3 inch colour touchscreen, it has a camera with motion detection, two voice-optimised microphones and a protected loudspeaker. Thanks to state-of-the-art technology, the DCS Touch Display uses very little energy, despite its wide range of functions. It can be combined with a Schüco DCS motion detector, Schüco DCS LED spotlight and DCS proximity switch, for example. Proper use also includes adhering to the installation and commissioning instructions. Any alternative use or a use beyond this remit is not in accordance with its purpose. Incorrect use or unauthorised modification of the product may result in death or serious injury, or damage to the product and other material assets.

The manufacturer / supplier shall not be liable for any resulting damage. The user alone bears the risk. Only original replacement parts may be used.

Children should be supervised to ensure that they do not play with the device..

2.4. General safety instructions

Follow the safety instructions in this document so as not to endanger your own life or that of others and to ensure error-free operation.



DANGER

Imminent danger resulting in death or severe injuries.

- ▶ Before any work is carried out on the product, all power packs must be disconnected and protected against anyone inadvertently switching them back on.
- ▶ Following each installation or alteration to the electrical system, carry out a test run to test all functions.
- ▶ When operating, note that Schüco windows and doors may open and close automatically when left unattended.

For reasons of simplicity, this documentation does not contain every detail of all product types and it cannot cover every possible installation, operation or maintenance scenario.

Should you require further information or encounter problems not dealt with in detail in these installation instructions, contact technical support +49 (0) 521 783 – 665. Moreover, we would like to point out that these installation instructions do not form part of or replace any previous or existing agreement or contract.

All obligations to be fulfilled by Schüco can be found in the appropriate sales contract, which also contains the complete current conditions of the warranty. These installation instructions do not add to or limit the contractual warranty conditions..

3. Contents of delivery, transportation and storage

3.1. Contents of delivery for Schüco DCS Touch Display

Open all the packing units. Check that no components are missing and familiarise yourself with the components.

Supplied with the Schüco DCS Touch Display are the following:

Art. No.	Description	
263 267	Schüco DCS Touch Display	<input type="checkbox"/>
263 272	DCS Touch Display installation tool	<input type="checkbox"/>
	Installation instructions (German/English)	<input type="checkbox"/>

3.2. Contents of delivery for Schüco IP secure connector

Open all the packing units. Check that no components are missing and familiarise yourself with the components.

Supplied with the IP secure connector are the following:

Art. No.	Description	
263 268	Schüco IP secure connector	<input type="checkbox"/>
	6 Plug-in connectors	<input type="checkbox"/>
	4 Fixing screws (including two spare screws)	<input type="checkbox"/>
	2 Cable ties for the mains lead cleat	<input type="checkbox"/>

3.3. Transportation and storage



NOTE

Damage to property.

- ▶ Protect against impact.
- ▶ Store only in dry interior rooms.
- ▶ Protect the device against moisture and dirt.

4. Technical data

4.1. Schüco DCS Touch Display

General data	
Installation type	Integrated in the profile in the DCS unit, leaf and outer frame, wall mounting and panel mounting
Material	Aluminium, PVC-U, toughened safety glass
Colour	Black
Weight	0,702 kg
Power supply	PoE+ IEE802.3at/Typ2 min 44 V
Alternative power supply	IEE802.3at
Input current (max.)	0,5 A
Call, speak, listen functions	
Audio coding	G.722, G.711 a-law, G.711 u-law
Video coding	H.264
Device data: Screen	
Screen	TFT active matrix, fully bonded
Size	4,3"
Resolution	480 x 800 Pixel
Screen brightness	Min. 450 cd/m ² , typically 600 cd/m ² , automatic
Angle of vision	80° in all directions
Colour depth	24 bit (true color)
Contrast ratio	1000 (typical); 700 (minimum)
Device data: Camera	
Camera opening angle	120° horizontally, 60° vertically
Video resolution	1280 x 960 (1.2 MP)
Front glass	TSG
Light sensitivity	Lens: f/2.0
Capability in backlit situations	HDR-based compensation

Access control	
Code lock	4 or 6-digit code entry
System features	
Peer-to-Peer operation	Yes
Ports	Line out, line in, 2 x USB, Ethernet
Inputs	1 input
Outputs	1 potential-free output, can be freely configured
Commissioning and maintenance properties	
Configuration	Basic settings on the DCS Touch Display, further settings via the web interface
Dimensions	
Housing	212 x 70 x 46 mm (H x W x D)
Climatic properties	
Permissible ambient temperature	-20 °C to +70 °C
Protection rating	IP 54 (when installed)
Guidelines	Conforms to RoHS, tested in accordance with IEC/EN 60950-1

4.2. Schüco IP secure connector

General	
Dimensions	262 x 59 x 26 mm (H x W x D)
Protection rating	IP 20
Temperature range	+5°C to +45°C
Air humidity	5% to 93%, non-condensing
Installation	Integrated in the DCS door profile or by the customer on the inside of the building
Key electrical data	
Power supply	12 - 30 V DC (+/-15 %) stabilised, von SELV/LPS (max 100 W) Spannungsquelle
Operating voltage	Recommended: 24 V DC, stabilised
DC OUT 3	With potential, 12-30 V DC, max. 1.5 A
OUT 1 / OUT 2	Potential-free
Contact loading of outputs OUT 1 and OUT 2	6-24 V AC/DC + - 15 %, max. 2 A von SELV/LPS (max 100 W) -Stromkreis
Guidelines	Conforms to CE and RoHS, IEC/EN 60950-1



INFORMATION

SELV electrical circuit

The relay output must only be used for SELV electrical circuits. A SELV electrical circuit in accordance with IEC/EN 60950-1 must be securely isolated (e.g. by means of double insulation) from a dangerous electrical circuit (e.g. 230 V or 110 V mains supply circuit) and must not exceed the voltage value of 60 V DC or 42.4 V ACpeak (30 V ACeff).

IP secure connector circuit breakers

All inputs and outputs of the IP secure connector are protected against voltages up to 60 V DC and 42 V AC. The „DC-OUT 3“ output also has circuit breakers to protect against external supply, short circuiting and reverse polarity.

You can find examples of connecting LED spotlights and/or motion detectors in Chapter 10, „Connection examples“, in the installation instructions..

5. System overview

5.1. Overview of system components

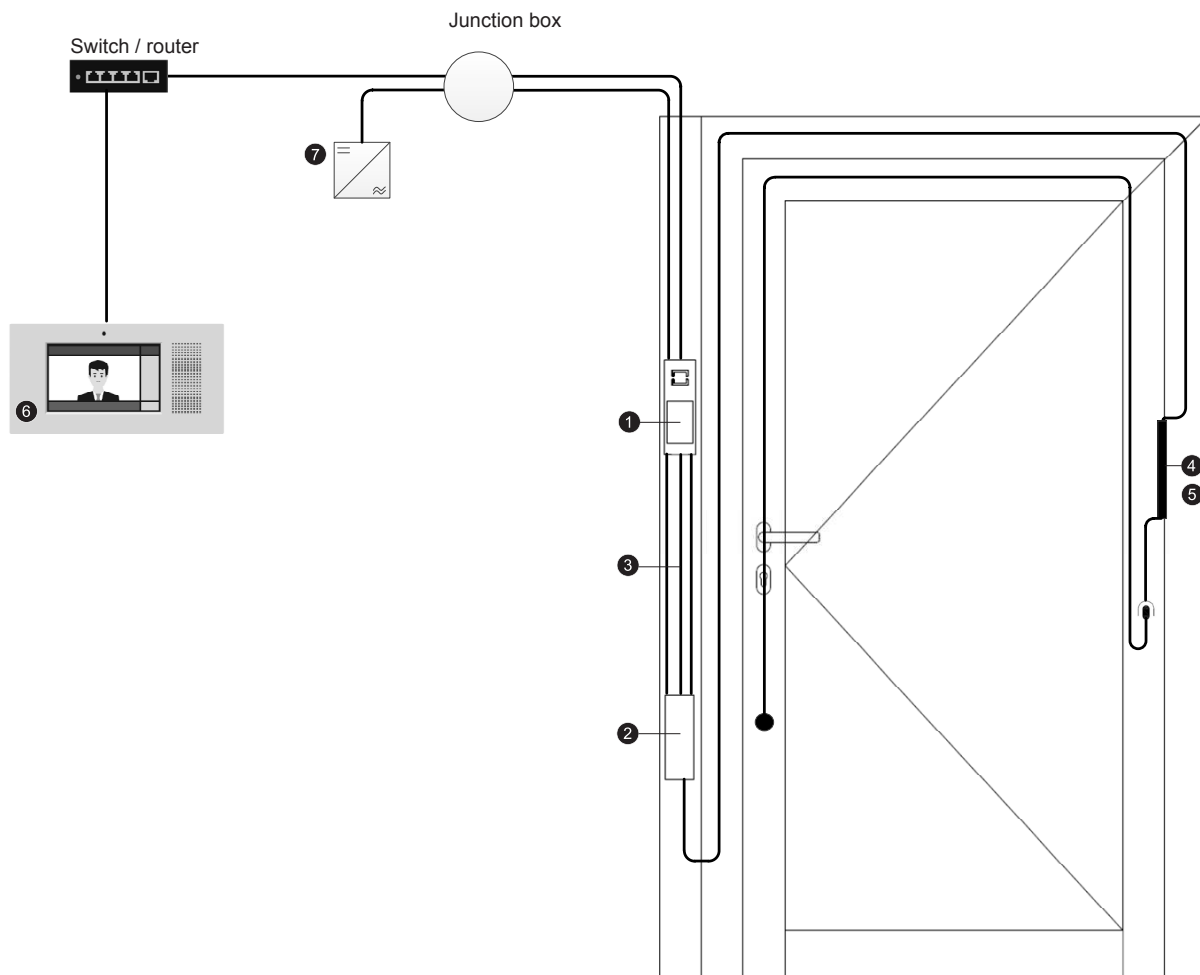

Pos.	Description	Art. No.	
1	DCS Touch Display	263 267	
2	IP secure connector	263 268	
3	Cable kits	Outer frame installation	263 278
		Leaf frame installation	263 277
		DCS in secondary leaf (double-leaf door)	263 279
4	Cable link connector	Can be split	263 016 263 017
5	Cable link connector	Network	263 273
6	Touch Display indoor intercom station*		263 283
7	Top hat rail power pack 24 V DC, 2 A		263 099

* or an alternative indoor intercom station in accordance with the compatibility list (see www.schueco.de/dcs-touchdisplay)

6. IP secure connector



INFORMATION

The DCS Touch Display can also be operated without the IP secure connector. Note that a suitable PoE+ switch must be provided by the customer in this case. If no IP secure connector is provided for the installation, you can skip this chapter.

The IP secure connector (Art. No. 263 268) is an optional device for greater output and safety. It protects the household electricity supply from unauthorised external manipulation attempts. In cases of unauthorised removal, the DCS Touch Display disconnects from the network. The IP secure connector also guarantees secure control of electric strikes and electric locks. It is recommended that you use the IP secure connector on all external doors.



INFORMATION

The IP secure connector must be installed on the inside of the building..
For perfect operation of the IP secure connector, connection to the Schüco DCS Touch Display is required..

6.1. Overview of IP secure connector

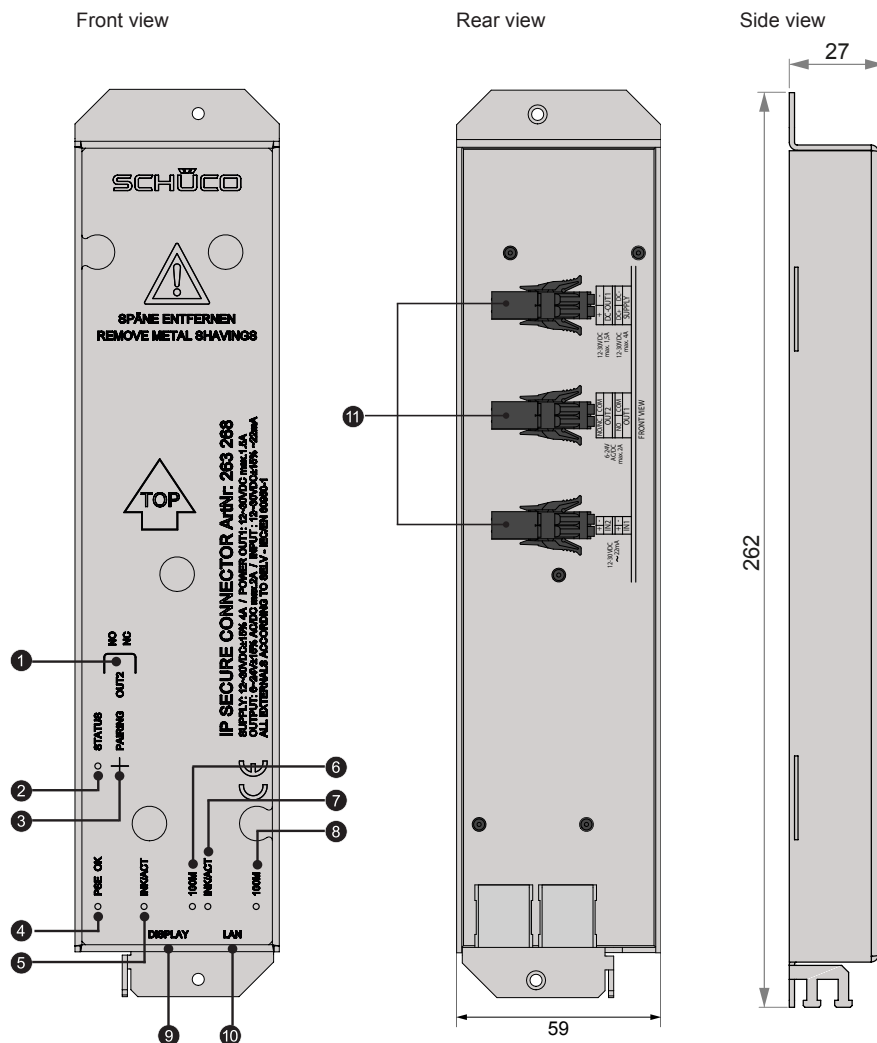

alle Maße in mm

①	Using the „OUT2“ switch, you can select whether the „OUT2“ relay is to function as a closer (NO/Normally Open) or as an opener (NC/Normally Closed).
②	The „STATUS“ LED indicates the status of the IP secure connector (see the following table).
③	By pressing the „PAIRING“ button, the IP secure connector can be paired with a DCS Touch Display.
④	The „PSE OK“ LED indicates the PoE status. If it is permanently lit, then there is a PoE+ power supply at the „DISPLAY“ RJ45 socket.
⑤	The „INK/ACT“ LED indicates whether data is being transmitted between the „DISPLAY“ RJ45 socket and the building’s internal switch.
⑥	The „100M“ LED indicates whether a transmission speed of 100 Mbps has been achieved between the IP secure connector and the DCS Touch Display at the „DISPLAY“ RJ45 socket.
⑦	The „INK/ACT“ LED indicates whether data is being transmitted between the „LAN“ RJ45 socket and the building’s internal switch.

8	The „100M“ LED indicates whether a transmission speed of 100 Mbps has been achieved between the IP secure connector and the building’s internal switch at the „LAN“ RJ45 socket.
9	The IP secure connector is connected to the DCS Touch Display via the „DISPLAY“ connection.
10	The IP secure connector is connected to the building’s internal switch/router via the „LAN“ connection.
11	The IP secure connector is supplied with power by means of the connections on the reverse side. In addition, further devices can be connected via two inputs and three outputs.

The „STATUS“ LED indicates the operating status of the IP secure connector. See the following table for the meaning of the signals:

Display	Meaning
Permanently lit	In the paired mode , the IP secure connector is assigned to a DCS Touch Display. No error has been detected.
Flashes slowly	In the unpaired mode , the IP secure connector has not been assigned to a DCS Touch Display. Even after the „PAIRING“ button has been pressed, the „STATUS“ LED flashes slowly until the IP secure connector has been assigned to a DCS Touch Display.
Flashes quickly	In the alarm mode , the connection of the IP secure connector to the building’s network is broken and the PoE+ power supply to the DCS Touch Display is disconnected (factory default).
Flashes slowly twice	In the maintenance mode , the alarm is deactivated for 15 minutes so that the DCS Touch Display can be removed.
Flashes quickly three times	In the so-called weak alarm mode , the IP secure connector is connected to a DCS Touch Display, however there is no connection to the building’s network (e.g. when the network cable is unplugged or in the event of power failure).
Flashes slowly twice and quickly once	In the update mode , new firmware is loaded into the IP secure connector.
Flashes in an SOS rhythm	In the rescue mode , an error occurred during the firmware update. A window appears in the browser.

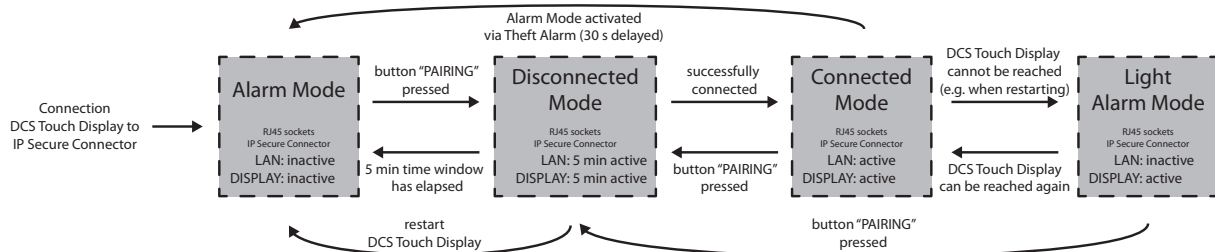

6.2. Connections for Schüco IP secure connector

The connections are located on the rear of the IP secure connector. The corresponding connectors are supplied with the product or are included in the cable kits.

The inputs and outputs on the rear of the IP secure connector are assigned as follows:

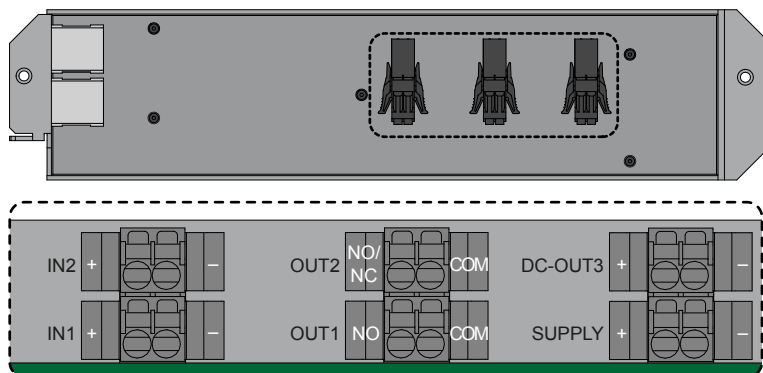

Voltage range		Notes
Power supply		
SUPPLY+	12–30 VDC (max. 4 A)	Max. 30 V DC Recommended power pack Art. No. 263 099 24 V 2 A
SUPPLY–	GND	
Output		
DC-OUT3+	12–30 VDC (max. 1,5 A)	Contact with potential
DC-OUT3–	GND	

Voltage range		Notes
Relay		
OUT1 NO	6–24 VAC/VDC (max. 2 A)	Potential-free contact Normally open (closer) max. 60 V DC
OUT1 COM		
OUT2 NO/NC	6–24 VAC/VDC (max. 2 A)	Potential-free contact Normally Open (closer) or Normally Closed (opener) can be set via the „OUT2“ switch
OUT2 COM		
Inputs		
IN1+	12–30 VDC (~ 22 mA)	Galvanically isolated
IN1–	GND	
IN2+	12–30 VDC (~ 22 mA)	Galvanically isolated
IN2–	GND	



INFORMATION

SELV electrical circuit

The relay output must only be used for SELV electrical circuits. A SELV electrical circuit in accordance with IEC/EN 60950-1 must be securely isolated (e.g. by means of double insulation) from a dangerous electrical circuit (e.g. 230 V or 110 V mains supply circuit) and must not exceed the voltage value of 60 V DC or 42.4 V ACpeak (30 V ACeff).

IP secure connector circuit breakers

All inputs and outputs of the IP secure connector are protected against voltages up to 60 V DC and 42 V AC. The „DC-OUT 3“ output also has circuit breakers to protect against external supply, short circuiting and reverse polarity.

You can find examples of connecting LED spotlights and/or motion detectors in Chapter 10, „Connection examples“, in the installation instructions..

6.2.1. Configuration of „OUT2“ on IP secure connector

Using the „OUT2“ switch, you can select whether the „OUT2“ relay is to function as a closer (NO) or as an opener (NC). Depending on the device connected, a closer can be used for an external lamp and an opener for function monitoring, for example.

- Closer (NO/Normally Open): If the closer is actuated, it closes a broken electrical circuit (factory setting).
- Opener (NC/Normally Closed): If the opener is actuated, it breaks an existing electrical circuit.

Proceed as follows to configure the „OUT2“ relay:

1. Using an object (e.g. screwdriver or pen), press down on the foil above the imprint „OUT2“ to access the switch.
2. Move the switch to the „NO“ position so that the „OUT2“ relay functions as a closer, or to the „NC“ position so that it functions as an opener.



INFORMATION

„NC“ switch position

In the „NC“ (opener) switch position, the „OUT2“ relay is an inverted closer. This means that this relay is open when there is no supply voltage at the IP secure connector.

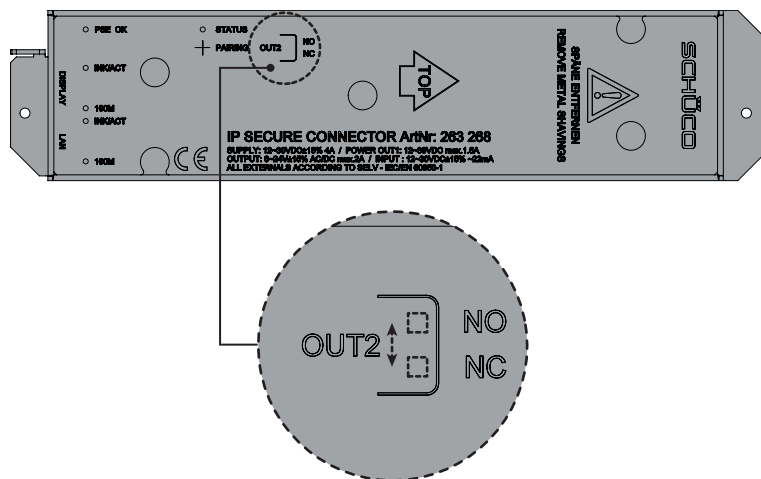

7. DCS Touch Display

The door communication and access control are supplied in this module which is operated via a touch interface. Door communication takes place via the open and unmodified SIP standard in accordance with RFC 3261. Between one and an almost unlimited number of users can be connected to the system.

There is the option to display pictures of the users or company logos next to the names on the screen. The access control is code-based. Via a simple user management system, access codes can be activated depending on times of the day and days of the week.

The digit buttons in the „code entry“ view can be displayed in a mixed, random order for increased security. It is therefore no longer possible to reproduce the codes from fingerprint impressions.

Settings for door communication and access control are made via a clearly laid-out web interface.

Basic settings, such as the brightness of the screen, can be carried out directly on the DCS Touch Display. The DCS Touch Display is equipped with inputs and outputs to which, for example, an electric strike for internal doors can be connected.

Data is communicated and power is supplied via a shared network cable.

7.1. Overview of DCS Touch Display

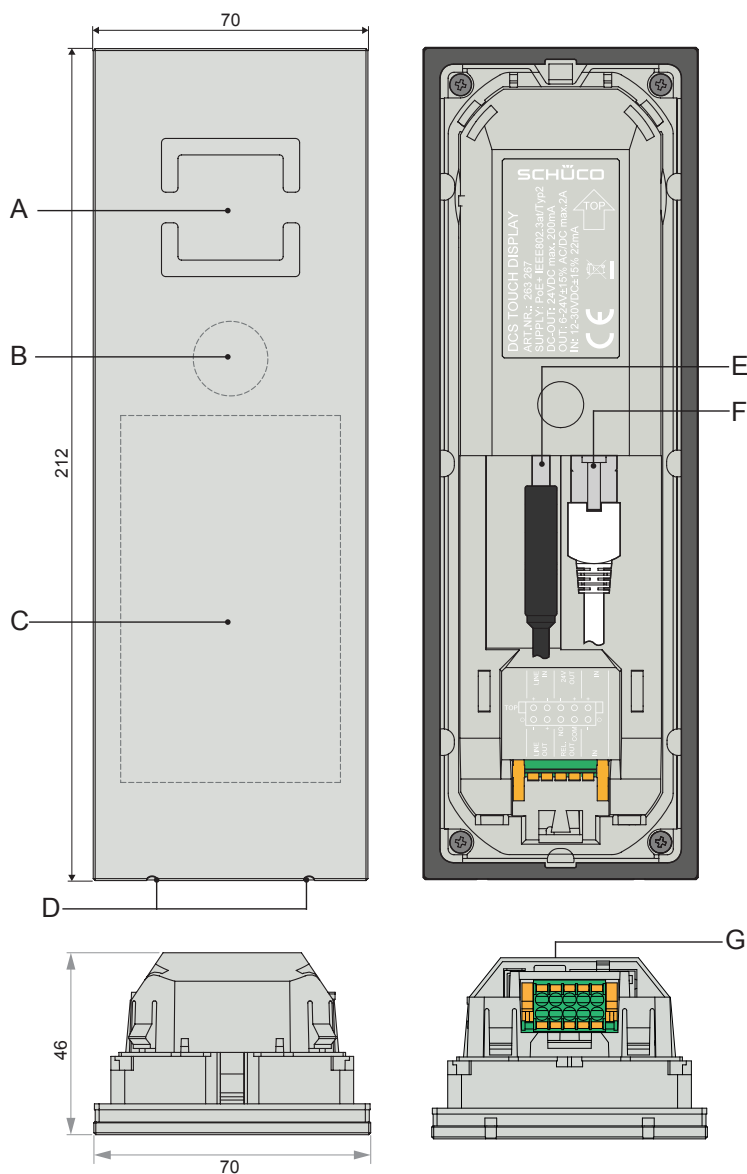

A	The loudspeaker openings are positioned such that the loudspeaker cannot be seen.
B	The high-resolution camera sits behind a tinted pane of glass, so that a person standing directly in front of it cannot see that it is a camera.
C	The 4.3 inch colour Touch Display can automatically adjust its brightness to suit the environment.
D	The voice-optimised microphones are concealed.
E	The two USB 2.0 ports turn the DCS Touch Display into a host for additional devices.
F	The RJ45 socket is used for the connection to the building's internal PoE+ switch or to the IP secure connector, whereby the DCS Touch display is supplied with power in the form of PoE+.
G	The inputs and outputs allow for additional devices to be directly connected to the Schüco DCS Touch Display.

7.2. Connections to Schüco DCS Touch Display

On the underside there is a 2 x 5-pole socket with the inputs and outputs for the Schüco DCS Touch Display. A suitable plug is supplied. The connections are assigned as follows:

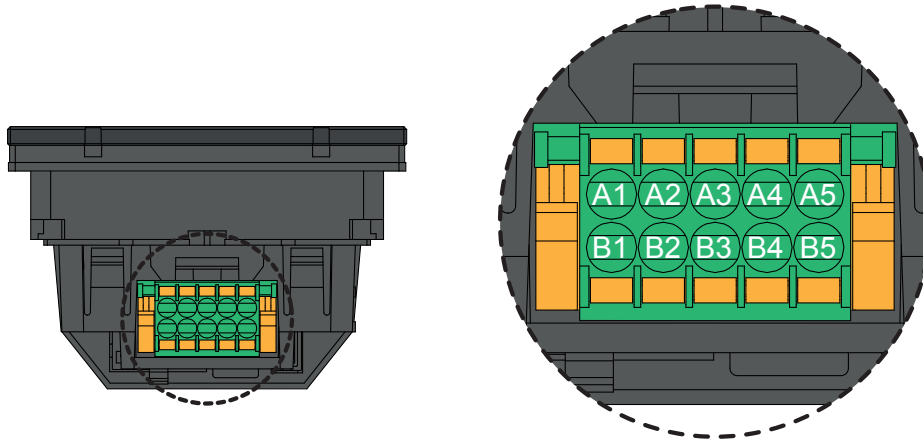

	Power supply	Voltage range	Notes
Input			
A5	IN+	12-30 V DC (22 mA)	Galvanic separation, max. 60 V DC / 42 V AC
B5	IN-	GND	
Potential-free output			
B3	OUT NO	6-24 V AC / V DC (max. 2 A)	Normally Open (closer), max. 60 W power rating
B4	OUT COM		
Output with potential			
A4	OUT24V-	GND	
A3	OUT24V+	24 V DC (max. 200 mA)	Max. 4.8 W
Audio			
A1	LINE-IN+		For microphones with line level
A2	LINE-IN-		
B2	LINE-OUT-		
B1	LINE-OUT+		e.g. for AFIL (audio frequency induction loop). This allows a hearing aid wearer to receive interference-free audio signals by means of the audio device)



INFORMATION

DCS Touch Display power supply

A power supply in the form of PoE+ is required in order to operate the DCS Touch Display. This is either provided by a suitable switch or by the IP secure connector. The maximum length of an Ethernet cable between the DCS Touch Display and the switch or IP secure connector is 50 m.

DCS Touch Display circuit breakers

All inputs and outputs of the DCS Touch Display are protected against voltages above 60 V DC and 42 V AC. The „OUT24V“ output also has circuit breakers to protect against external supply, short circuiting and reverse polarity.

SELV electrical circuit

The relay output must only be used for SELV electrical circuits. A SELV electrical circuit in accordance with IEC/EN 60950-1 must be securely isolated (e.g. by means of double insulation) from a dangerous electrical circuit (e.g. 230 V or 110 V mains supply circuit) and must not exceed the voltage value of 60 V DC or 42.4 V ACpeak (30 V ACeff).

7.2.1. Connection to lock technology

If no IP secure connector is used, proceed as follows to connect an electric lock to the DCS Touch Display:

1. Connect the green control wires (ST) of the SafeMatic to the „A4“ socket („OUT COM“) and the wires that supply power to the „A3“ socket („OUT NO“).
2. Ensure that the cables are laid correctly.

7.2.2. Dismantling

In order to be able to remove the Schüco DCS Touch Display, the alarm must be deactivated and the unlocking mechanism released. The Schüco DCS Touch Display installation tool (Art. No. 263 272) is required for the latter and is supplied with the Schüco DCS Touch Display.



INFORMATION

Removing the Schüco DCS Touch Display

It is essential that you observe the steps for deactivating the alarm prior to removal, as otherwise the alarm mode will be activated. If the DCS Touch Display is connected to an IP secure connector in the alarm mode, the connection between the DCS Touch Display and the building's network will be disconnected when an attempt is made to remove the DCS Touch Display improperly. In this way, any unauthorised access from outside via this network cable is successfully prevented.

To unlock the DCS Touch Display, proceed as follows, provided that it has already been commissioned or connected to an IP secure connector:

1. Tap the display (if the house number is displayed) and swipe left to display the code entry.
2. Enter the administrator code („1234“ if it has not yet been changed) and tap „OK“.

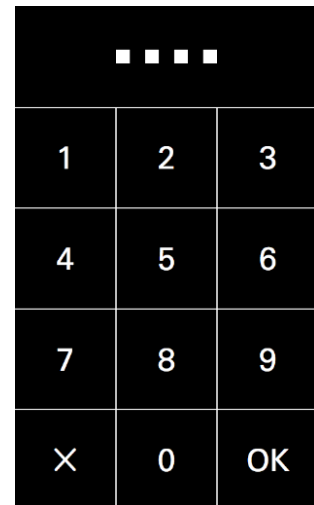

3. Select the „Alarm“ option.

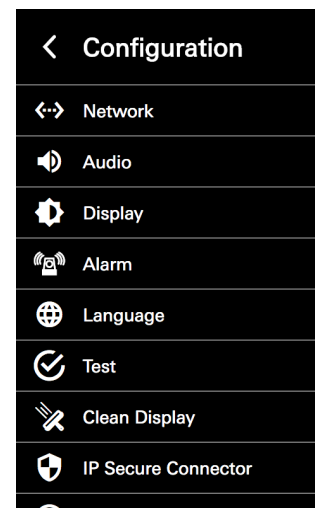

4. Tap „Deactivate“ to avoid the DCS Touch Display from changing to the alarm mode when it is tilted.



Proceed as follows to remove the Schüco DCS Touch Display:

1. Guide the unlocking nibs of the Schüco DCS Touch Display installation tool into the top loudspeaker opening of the DCS Touch Display.
2. To release the unlocking mechanism, slide the DCS Touch Display installation tool upwards as far as possible.

3. Carefully push the bottom end of the DCS Touch Display installation tool towards the DCS unit in order to release the Schüco DCS Touch Display from its fixed position.
4. Carefully remove the Schüco DCS Touch Display from the Schüco DCS unit. Disconnect the plug from the device and remove the entire electronics assembly.

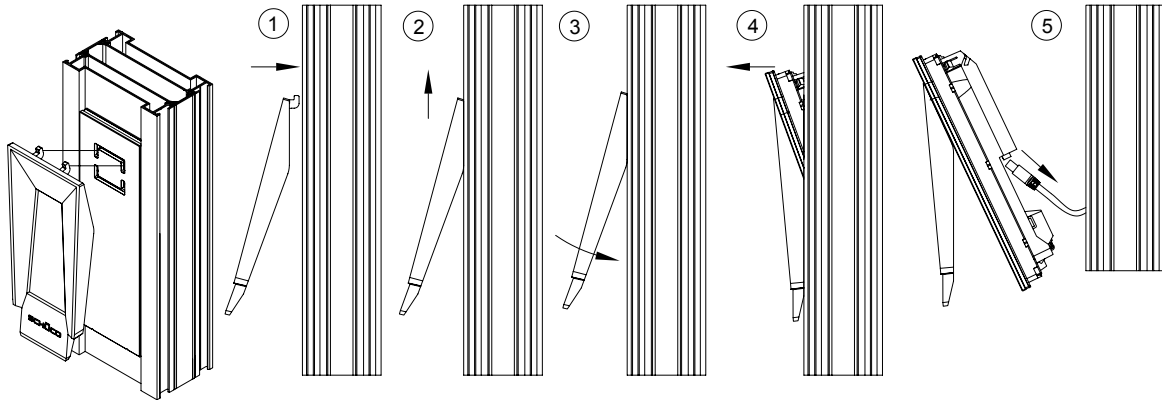

INFORMATION

The DCS Touch Display installation tool can also be used as a protective compartment to store the DCS Touch Display.

8. Screen surface

The DCS Touch Display can be operated via the 4.3 inch touchscreen.

The DCS Touch Display is divided into the following five main screens (from left to right):

- Start screen: Here you can display the house number or any desired image in 480 x 800 pixel format.
- Doorbell list: Here you can display all the contacts you can call or for whom a stored function can be activated.
- Code entry: Here you can enter a four or six-digit access code in order to display the „Configuration“ view, for example.
- Select action: Here you can select one of several actions permitted for the user as applicable.
- Configuration: Here you can make basic settings directly on the DCS Touch Display.

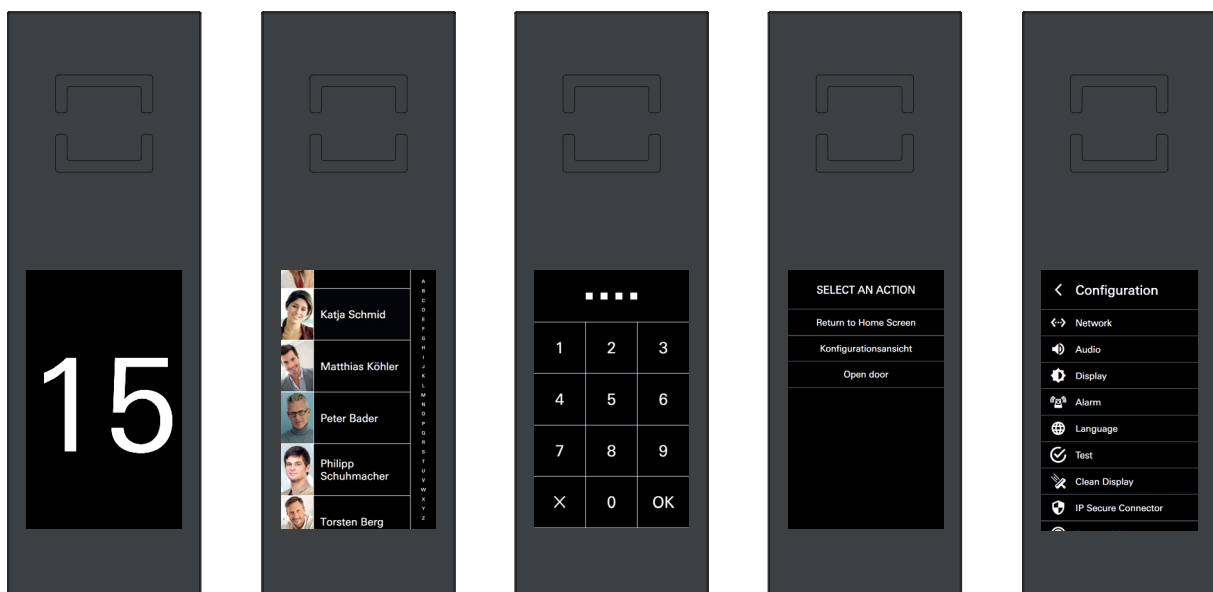

8.1. Start screen

In the „Start screen“ view, the house number or an image can be displayed. To exit the „Idle“ device status, the screen must be tapped or a movement detected by the integrated camera of a configured motion detector (see „9.11 Motion detection“). For the „Start screen“ view, there are five display options (see „9.9 Device“):

- The house number alone is displayed horizontally.
- The house number alone is displayed vertically.
- Only an image is displayed.
- The house number is displayed horizontally along with an image. In this case, the house number appears over the image in white font.
- The house number is displayed vertically along with an image. In this case, the house number appears over the image in white font.

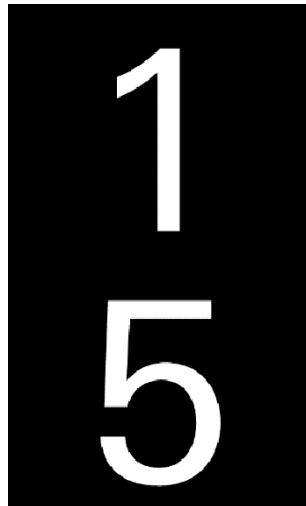

8.2. Doorbell list

Tap the screen in standard configuration to switch to the „Doorbell list“ view. Here all contacts and action sequences are listed which have been configured in the web interface on the „Buttons“ page (see „9.12 Buttons“). Depending on how many buttons have been configured, the screen of the DCS Touch Display presents two different view options:

- View without scroll bar: If five buttons or fewer have been configured, it is not possible to scroll up and down the screen.
- View with scroll bar: If more than five buttons have been configured, a scroll bar appears on the right-hand side of the screen.

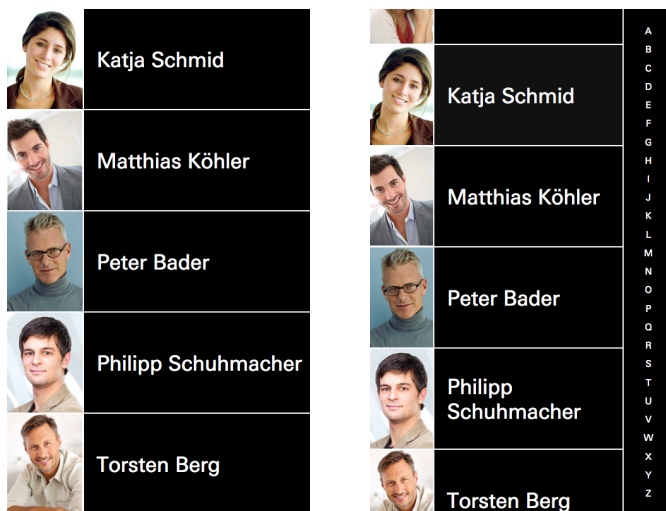

INFORMATION

Doorbell list display

Contacts in the „Doorbell list“ view can be sorted either by first name or surname. The contacts in the „Doorbell list“ view are listed according to the option which has been selected. The scroll bar on the right of the DCS Touch Display screen only appears once the buttons have been sorted by first name or surname. You can find more information about sorting contacts in the „Doorbell list“ view under „9.15 Contacts“.

Proceed as follows to scroll through the „Doorbell list“ view:

1. For optimum scrolling upwards and downwards, position your finger in the middle of the scroll bar.
2. Swipe upwards or downwards. The alphabet on the scroll bar shows the direction in which you are scrolling. In addition, the box in the middle of the screen shows which contacts are being shown with which initial letters. Alternatively, you can also tap a letter in the scroll bar in order to move directly to the desired initial letter.

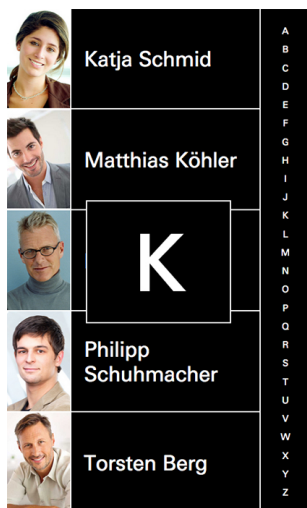

8.2.1. Making a call

Tap the desired contact in order to make a call. Depending on how the counterpart intercom station (e.g. SIP telephone, SIP app) was configured, the call is promptly accepted or ringing continues until the call is accepted or automatically ended after a time-out of 45 seconds. In order to end a call manually whilst calling a contact, you must tap the „Bell“ symbol in the bottom part of the screen.



INFORMATION

Calls

Calls are only possible once contacts have been created and the corresponding buttons have been configured.

Corresponding to the two call statuses „Calling“ and „Talking“, there are two different views:

- Calling: The „Bell“ symbol in the bottom part of the screen makes clear that the counterpart intercom station is ringing and that the call has not yet been accepted.
- Talking: The „Mouth“ symbol in the bottom part of the screen makes clear that the call has been established and that dialogue can now begin.



INFORMATION

Profile picture

If no profile picture has been uploaded for the respective contact, the standard avatar is displayed.

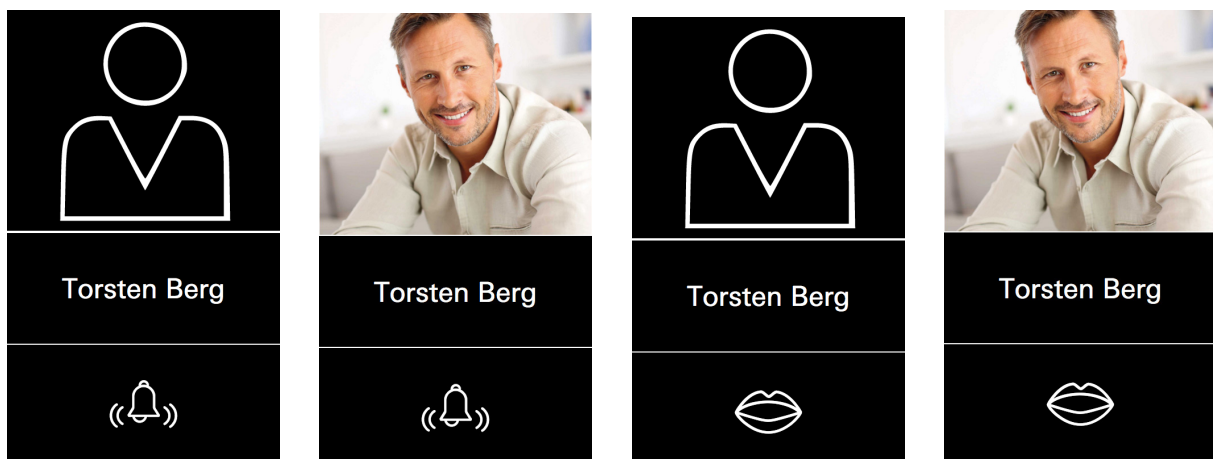

8.2.2. Ending a call

Tap the „Mouth“ symbol in the bottom part of the screen to end the call. As soon as the call is ended by you or the person at the counterpart intercom station, the DCS Touch Display shows the „Doorbell list“ once again.

8.3. Entering the access code

Swipe to the left from the „Doorbell list“ view to display the „Code entry“ view. From here it is possible to access the „Configuration“ view or trigger another, previously defined event (e.g. actuate a door opener or deactivate an alarm system).

Besides the digits „0“ to „9“ for the access code, there are three further buttons:



Switch to the „Doorbell list“ view (alternatively you can swipe to the right).



Delete the last digit entered (if a digit has been entered, this button appears instead of the button described above).



Confirm access code.

For security reasons, the „Code entry“ view allows access codes of up to eight digits to be entered. However, only four or six-digit access codes can be generated in the web interface (see „9.18.8 Changing the access code“).

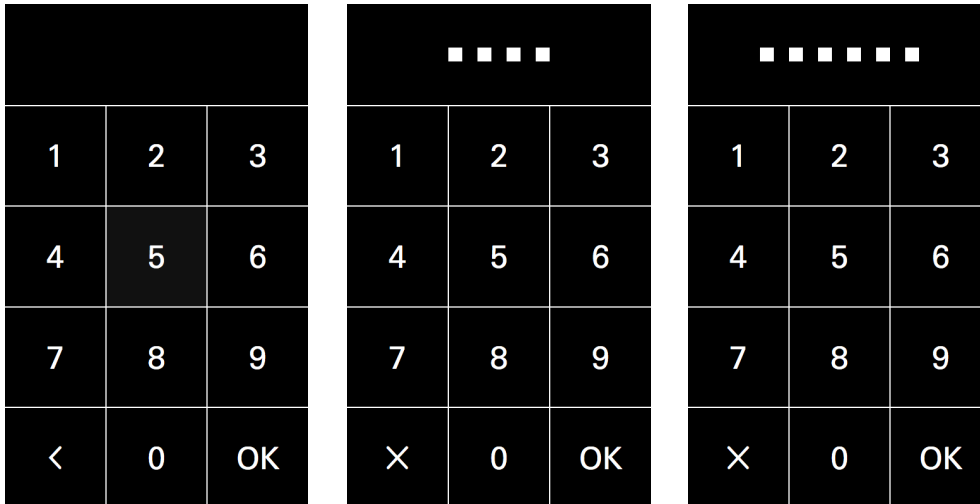

INFORMATION

Incorrect access code

If an incorrect access code is entered, the squares which represent the access code digits will be „shaken“ in an animation. After two seconds, these squares are faded out so that the code can be entered afresh. If the access code has been entered incorrectly three times, you must wait for five seconds until a new entry is possible. For the fourth incorrect entry, the waiting time is 10 seconds; for the fifth incorrect entry, the waiting time is 20 seconds; and for the sixth incorrect entry, the waiting time is 30 seconds. If the access code has been entered incorrectly more than seven times, you must always wait for 60 seconds until a new entry is possible. During the waiting time, it is possible to return to the „Doorbell list“ view via . If a correct access code is entered in between times, the waiting time is reset once more.

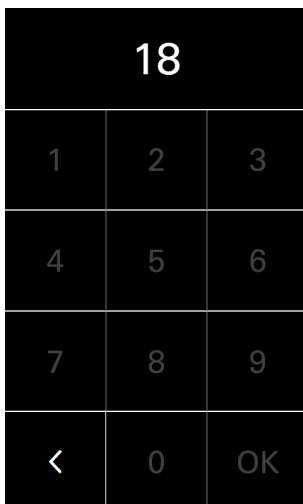

If the access code entered was correct, there are two options:

1. If the user has only been granted permission for one action sequence, this is carried out immediately (e.g. actuate the door opener or display the „Configuration“ view).
2. If the user has been granted permission for more than one action sequence, the „Select action“ view appears, where it is possible to select one of several action sequences (e.g. „Open door“ or „Configuration view“) or switch to the „Start screen“ view via the option „Back to start screen“ (see „8.5 Select action“).

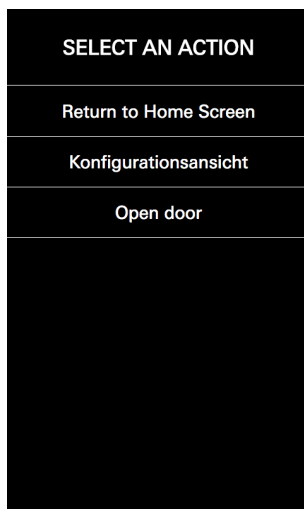

8.4. Configuration

Enter your personal access code or the access code of the administrator in the „Code entry“ view in order to display the „Configuration“ view. Here it is possible to make different settings directly on the DCS Touch Display.



INFORMATION

Standard administrator code

The standard code for the administrator is „1234“. It is recommended that you change this as soon as possible (see „9.18.8 Changing the access code“).

The following options are available in the „Configuration“ view:

- Network: Here you can assign an IP address for the DCS Touch Display.
- Audio: Here you can set the output volume („Loudspeaker“) and input volume („Microphone“).
- Screen: Here you can set the brightness of the screen.
- Alarm: Here you can activate or deactivate the anti-theft device.
- Language: Here you can set the screen language of the DCS Touch Display.
- Test: Here you can initiate the self-test for the DCS Touch Display.
- Clean display: Here you can deactivate the screen of the DCS Touch Display for 30 seconds.
- IP secure connector: Here the DCS Touch Display can be paired with or separated from an IP secure connector.
- Remote maintenance: Here you can activate remote maintenance for support purposes.



INFORMATION

Back to start screen

Tap in the top left  in order to switch to the „Start screen“ view.

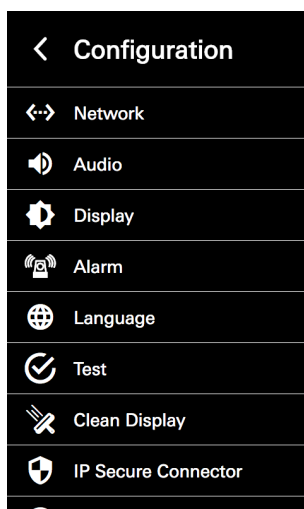

8.4.1. Error messages

The DCS Touch Display displays error messages in the form of message boxes in the bottom part of the screen as soon as an error has been detected (e.g. connection errors, incorrect configuration or server errors). In this case check the configuration.

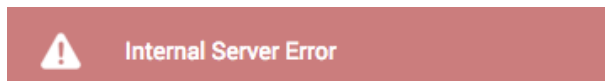

8.4.2. Network

In the „Network“ configuration view, it is possible to assign an IP address to the DCS Touch Display. The following options are available for this:

- DHCP: If this checkbox is checked, the DCS Touch Display automatically searches for a free IP address in the building's network, the corresponding subnet mask and the default gateway. This information is then displayed in the „IP address“, „Subnet mask“ and „Default gateway“ field.
- IP address: Here you can enter the IP address of the DCS Touch Display.
- Subnet mask: Here you can enter the corresponding subnet mask for the IP address.
- Default gateway: Here you can enter the corresponding default gateway for the IP address



INFORMATION

Assigning an IP address

Only IPv4 addresses can be assigned to the DCS Touch Display. Manually assigned IP addresses are only assigned to the DCS Touch Display once you tap „Save“. In order to discard an entry, you can either tap „Cancel“ or .

On delivery, DHCP is activated for the DCS Touch Display. If a DHCP server has been found, the DCS Touch Display displays the information in the „IP address“, „Subnet mask“ and „Default gateway“ fields. Proceed as follows to manually assign an IP address to the DCS Touch Display:



INFORMATION

DHCP

This enables the assignment of the network configuration by means of a server (e.g. DSL router).

On delivery, DHCP is activated for the DCS Touch Display. If a DHCP server has been found, the DCS Touch Display displays the information in the „IP address“, „Subnet mask“ and „Default gateway“ fields. Proceed as follows to manually assign an IP address to the DCS Touch Display:

1. Open the „Network“ configuration view.
2. Tap the „DHCP“ checkbox to remove the checkmark.

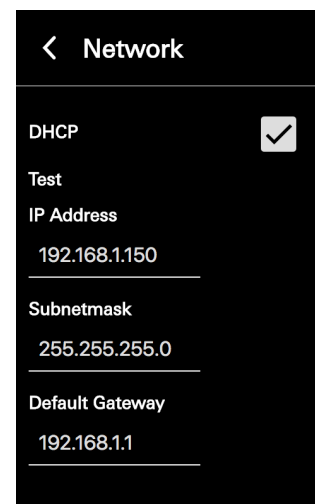

3. Tap the „IP address“ field and enter an IP address using the keypad that appears.
4. Tap „Save“.

< Network		
IP Address		
192.168.1.150		
1	2	3
4	5	6
7	8	9
×	0	.
Cancel		Save

5. Repeat steps „2“ and „3“ for the „Subnet mask“ and „Default gateway“ fields.

< Network		
Subnetmask		
255.255.255.0		
1	2	3
4	5	6
7	8	9
×	0	.
Cancel		Save

< Network		
Default Gateway		
192.168.1.1		
1	2	3
4	5	6
7	8	9
×	0	.
Cancel		Save



INFORMATION

DHCP function activated

While the „DHCP“ checkbox is checked, it is not possible to amend the „IP address“, „Subnet mask“ and „Default gateway“ fields.

8.4.3. Audio

In the „Audio“ configuration view, it is possible to make basic audio settings on the DCS Touch Display. The following options are available for this:

- **Loudspeaker:** Here you can adjust the output volume of the loudspeaker on the DCS Touch Display. Here the value is set to the middle value as standard. By moving the slider right, you can increase the volume; by moving the slider left, you can decrease it.
- **Microphone:** Here you can adjust the degree of preamplification of the microphone on the DCS Touch Display. Here the value is set to the middle value as standard. By moving the slider right, you can increase the volume; by moving the slider left, you can decrease it.

Proceed as follows to adjust the volume settings on the DCS Touch Display:

1. Open the „Audio“ configuration view.
2. Adjust the volume by means of the „Loudspeaker“ and/or „Microphone“ controls.

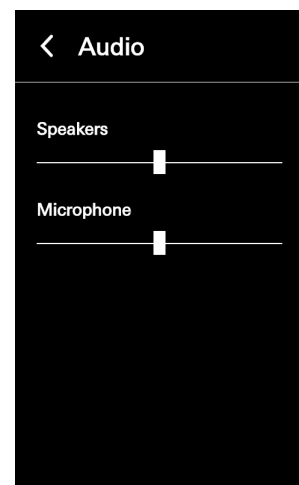

INFORMATION

Applying settings

Settings are applied and saved immediately when adjusting a control.

Display of the value

The set value is displayed only in the web interface and not on the screen of the DCS Touch Display.

8.4.4. Screen

In the „Screen“ configuration view, it is possible to set the brightness for the screen on the DCS Touch Display. The following option is available for this:

- **Brightness:** Here you can adjust the brightness of the screen on the DCS Touch Display between „0“ and „100“. Here the value is set to „80“ as standard.



INFORMATION

Display of the value

The set value is displayed only in the web interface and not on the screen of the DCS Touch Display.

Proceed as follows to adjust the screen brightness in the DCS Touch Display:

1. Open the „Screen“ configuration view.
2. Adjust the brightness by means of the „Brightness“ control.

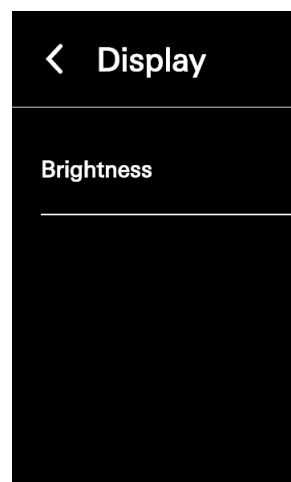

INFORMATION

Applying settings

Settings are applied and saved immediately when adjusting the control.

8.4.5. Alarm

In the „Alarm“ configuration view, it is possible to activate the anti-theft device or to deactivate it for the removal of the DCS Touch Display.



INFORMATION

Anti-theft device

It is essential that you observe the steps for deactivating the anti-theft device prior to removal, as otherwise the alarm mode will be activated. If the DCS Touch Display is paired with an IP secure connector in the alarm mode, the network connection and the PoE+ power supply between the IP secure connector and the DCS Touch Display will be disconnected after 30 seconds when an attempt is made to remove the DCS Touch Display incorrectly. In this way, any unauthorised access from outside via this network cable is successfully prevented. To enable recommissioning of the DCS Touch Display, it must be put back in its original position and the „PAIRING“ button pressed on the IP secure connector. If necessary, the anti-theft device must be reactivated, as this function is deactivated in the alarm mode.

Proceed as follows to activate the anti-theft device of the DCS Touch Display:

1. Open the „Alarm“ configuration view.
2. Tap „Activate“.

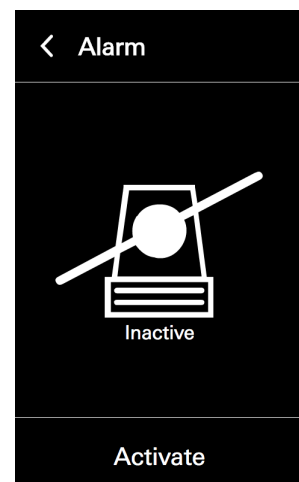

Proceed as follows to deactivate the anti-theft device of the DCS Touch Display:

1. Open the „Alarm“ configuration view.
2. Tap „Deactivate“ to avoid the DCS Touch Display from switching to the alarm mode when it is removed.



8.4.6. Language

In the „Language“ configuration view, it is possible to set the screen language of the DCS Touch Display. The following options are available for this:

- German
- English

Proceed as follows to set the language on the DCS Touch Display:

1. Open the „Language“ configuration view.
2. Tap the desired language.

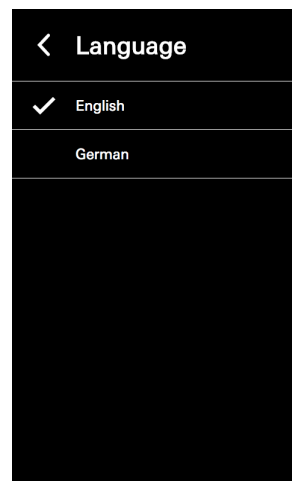

INFORMATION

Applying settings

Settings are applied and saved by tapping an option.

8.4.7. Test

In the „Test“ configuration view, it is possible to perform the self-test for the DCS Touch Display. This is subdivided into the following three steps:

- Self-test 1/3 (audio): Here the loudspeaker and microphones of the DCS Touch Display can be tested for perfect functionality.
- Self-test 2/3 (video): Here the image from the internal camera can be displayed on the screen of the DCS Touch Display.
- Self-test 3/3 (I/Os - inputs and outputs): Here it is possible to see which connections are occupied, and which outputs can be switched.

Proceed as follows to start and end the self-test on the Schüco DCS Touch Display:

1. Open the „Test“ configuration view.

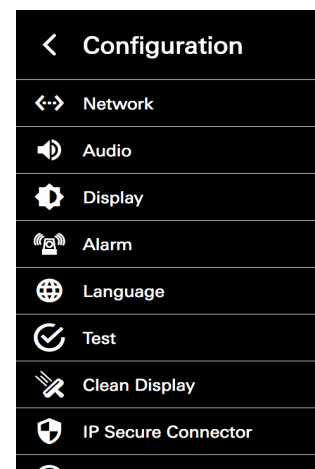

2. Tap  to start the audio test. A noise signal is now emitted via the loudspeaker, which is recorded by the microphones and then analysed.

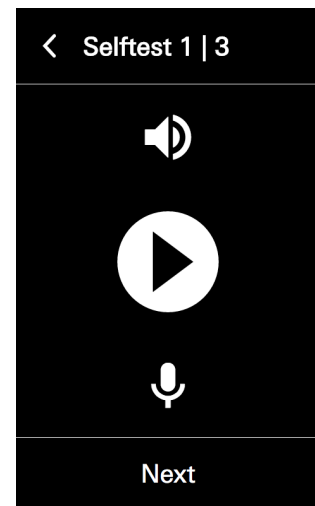

3. During this time, an animation is played on the screen. If an audio test is successful, a checkmark is displayed in the middle of the screen.

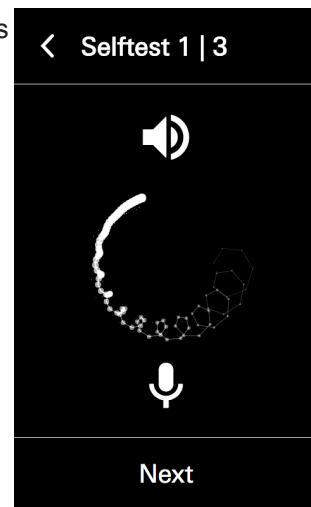

4. Tap „Next“.

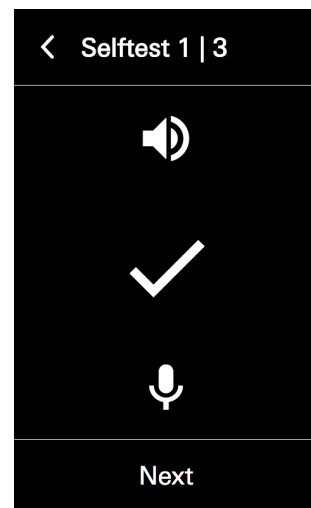

5. Tap  to start the video test.

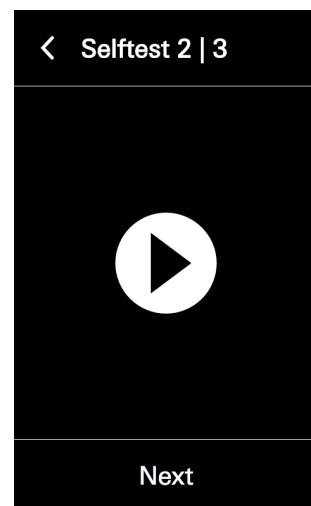

6. If a video test is successful, the video image from the internal camera is displayed on the screen. It may be that the video image is displayed with a time delay. However, it is free from faults if a video image can be seen.
7. Tap „Next“. The I/O test is started.



8. If an output has been switched or an altered input value recognised, the button of the corresponding input or output is highlighted in white.
9. Tap „Test“ next to the desired output to activate a door opener connected to it, for example.
10. Tap „Next“ to finish the self-test.

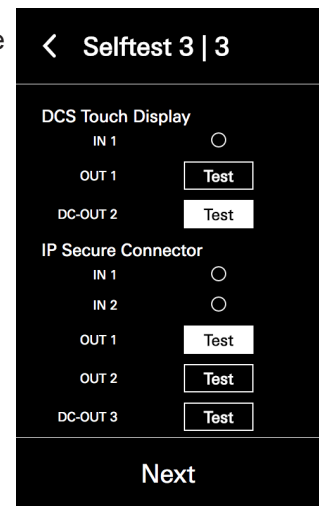

If the audio test was unsuccessful, an „X“ is displayed instead of a checkmark.
 If the video test was unsuccessful, the screen remains black.

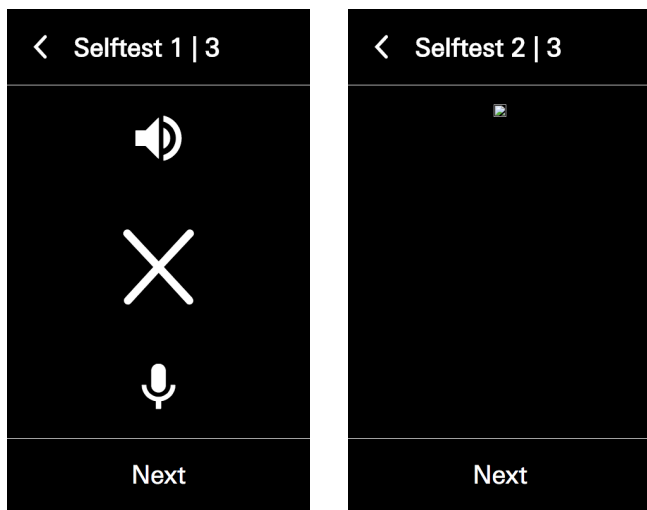

8.4.8. Cleaning the display

In the „Clean display“ configuration view it is possible to deactivate the screen of the DCS Touch Display for 30 seconds. This prevents any buttons on the screen from being pressed inadvertently during cleaning (e.g. wiping with a cloth). While the screen is deactivated, a countdown can be seen. As soon as this has run down, the screen switches back to the „Configuration“ view.

Proceed as follows to deactivate the screen of the DCS Touch Display for 30 seconds:

1. Open the „Clean display“ configuration view.

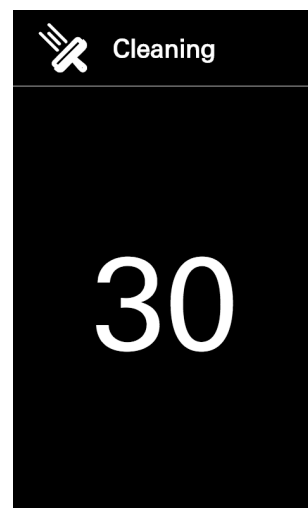

INFORMATION

Cleaning

The screen is immediately deactivated when the „Clean display“ configuration view has been called up. For information on cleaning, see „12 Maintenance and cleaning“.

8.4.9. IP secure connector

In order to connect the DCS Touch Display to an associated IP secure connector, it is necessary to search for the IP secure connector. If the DCS Touch Display or the IP secure connector is removed or replaced, the connection must be dissolved once more. If no IP secure connector is provided for the installation, you can skip this point.

To connect the DCS Touch Display to an IP secure connector, proceed as follows:

1. Open the „IP secure connector“ configuration view.
2. Tap „Search and connect“. Once the DCS Touch Display is connected to an IP secure connector, the message „Connected to IP secure connector (serial number)“ appears.

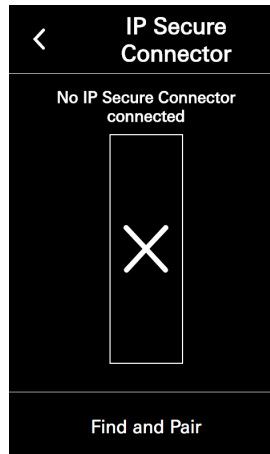

INFORMATION

No IP secure connector found

If no IP secure connector is connected to the DCS Touch Display or the „Search and connect“ button has not yet been pressed since an IP secure connector has been connected to the DCS Touch Display, the message „No IP secure connector connected“ can be seen on the screen.

To disconnect the DCS Touch Display from an IP secure connector, proceed as follows:

3. Open the „IP secure connector“ configuration view.
4. Tap „Disconnect connection“.





INFORMATION

IP secure connector cannot be found

If an IP secure connector that is already connected can no longer be found, the message „Cannot be found“ is displayed next to its serial number. In addition, a large exclamation mark can be seen in the pictogram. In this case, check the ethernet connection and the power supply of the IP secure connector. If the IP secure connector has been removed and a new one installed, disconnect the connection and connect the new IP secure connector to the DCS Touch Display.

8.4.10. Remote maintenance

It is possible for Support to carry out remote maintenance on the DCS Touch Display.

For this purpose, the „Remote maintenance“ function must be activated.

The following information is available in the „Network status“ section:

- Status: Here the status of the remote maintenance is displayed.

To start and stop remote maintenance for support purposes, proceed as follows:[]

1. Open the „Remote maintenance“ configuration view.
2. Tap „Start“. The status changes to „Started“ and two port numbers are displayed.



3. Tap „Stop“. The status changes to „Not active“.



NOTE

Damage to property.

- ▶ Do not stop remote maintenance under any circumstances unless you are told to do so by Support.



INFORMATION

Safety information

The remote maintenance is not a permanent interface for contacting Schüco. Use of this interface requires the express approval of the system operator/person responsible for the system on site.

8.4.11. Close configuration

Via the arrow at the top left, it is possible to switch from the „Configuration“ view to the „Doorbell list“ view.

To leave the „Configuration“ view and switch to the „Doorbell list“ view, proceed as follows:

1. Tap „Stop“ to deactivate remote maintenance, as otherwise the remote maintenance will remain active.
2. Tap .



INFORMATION

Leaving configuration

After switching to the „Doorbell list“ view via the „Close configuration“ button, it is necessary to enter the access code again in the „Code entry“ view in order to call up the „Configuration“ view once more.

8.5. Select action

If multiple action sequences have been stored for a single user, the “Select action” view appears after the access code is entered. In the “Select action” view, it is possible to carry out an action sequence or return to the “Start screen” view.

To select an action sequence or return to the “Start screen” view, proceed as follows:

Tap a button with a stored action sequence (e.g. “Call up configuration” or “Actuate door opener”) or tap the “Return to home screen” button.

1. Tap a button with a stored action sequence (e.g. „Open door“ or „Configuration view“) or tap „Back to start screen“.

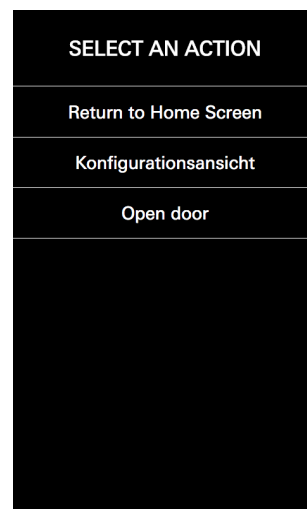

If no action sequences have been stored for the user, the „Select action“ view appears with „Back to start screen“ as the sole option.

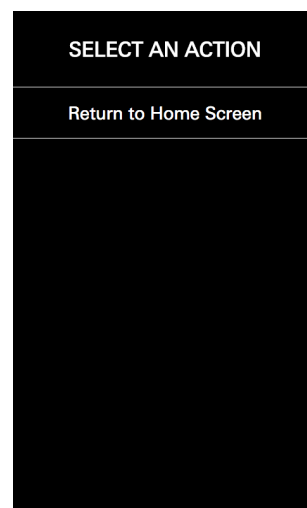

INFORMATION!

Only one action sequence stored

If only one action sequence has been stored for the user, this is performed immediately without the „Select action“ view being displayed first.

8.6. Symbols

The DCS Touch Display can display seven different symbols in total. Depending on the configured action sequence, these are displayed either immediately after the access code is entered or after an action sequence is selected.

The following symbols are available:

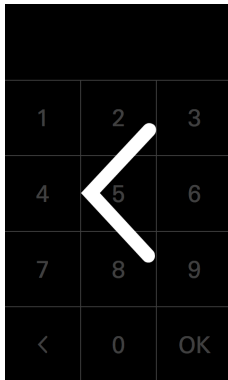

Arrow



Bell right



Bell left

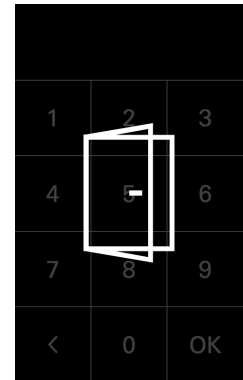

Door



Mouth

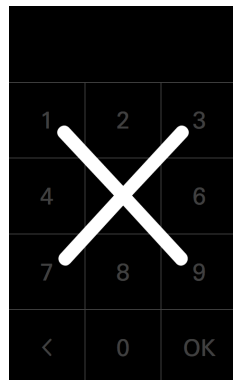

X



Alarm off



Alarm on

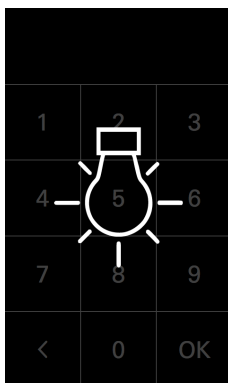

Light

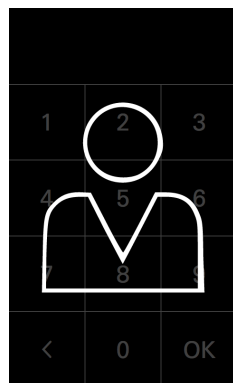

Avatar



Building



INFORMATION

Symbol view

For as long as a symbol is displayed, the screen of the DCS Touch Display is deactivated. The time for which a symbol is displayed depends on the configuration of the action sequence.

9. Web interface

The web interface is a browser-based application via which it is possible to configure the DCS Touch Display and the IP secure connector as well as read all relevant data.



INFORMATION

Recommended browser

The web interface can generally be used with all browsers. It is recommended, however, that you use the most up-to-date version of Google Chrome.

9.1. Accessibility

As soon as the DCS Touch Display is connected to the building's network, the web interface can be called up from any computer within the network (see „9.2 Calling up the web interface“).



INFORMATION

Ability to be called up

The web interface of the DCS Touch Display can only be called up after the device has booted up.

If the connection between the DCS Touch Display and the building's network is broken while the web interface is open, the web interface will indicate that this has occurred with the  symbol in the top right section of the browser next to „log in“ and „log out“. As soon as there is once more a connection between the DCS Touch Display and the building's network, the symbol will be hidden again.

9.2. Calling up the web interface

To be able to call up the web interface, the IP address of the DCS Touch Display is necessary. This must be entered in the address bar of the browser (e.g. „192.168.1.150“).

If the IP address is not known, it can be displayed on the DCS Touch Display.

Proceed as follows to display the IP address on the DCS Touch Display and then call up the web interface:

1. Tap the display and swipe to the left to call up the „Code entry“ view. Tap the screen and swipe to the left to display the „Code entry“ view.
2. Enter the administrator access code and tap „OK“.

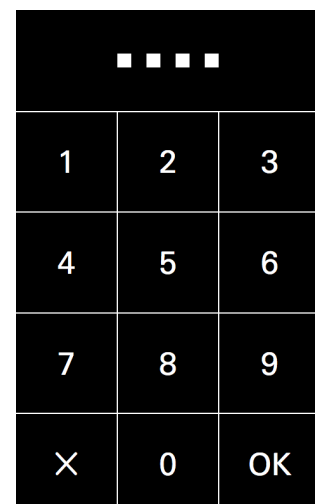

3. If there are multiple action sequences to select from, tap „Configuration view“.

4. Open the „Network“ configuration view.

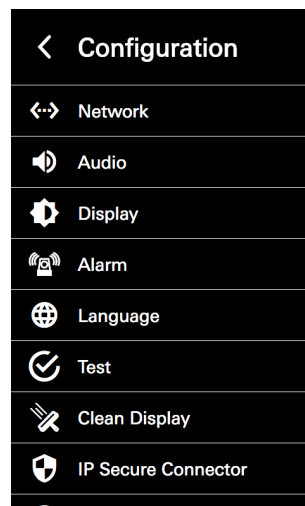

5. Note the IP address and enter this into your browser (e.g. „192.168.1.150“). If the web interface can be reached by means of your browser, the homepage will be displayed.

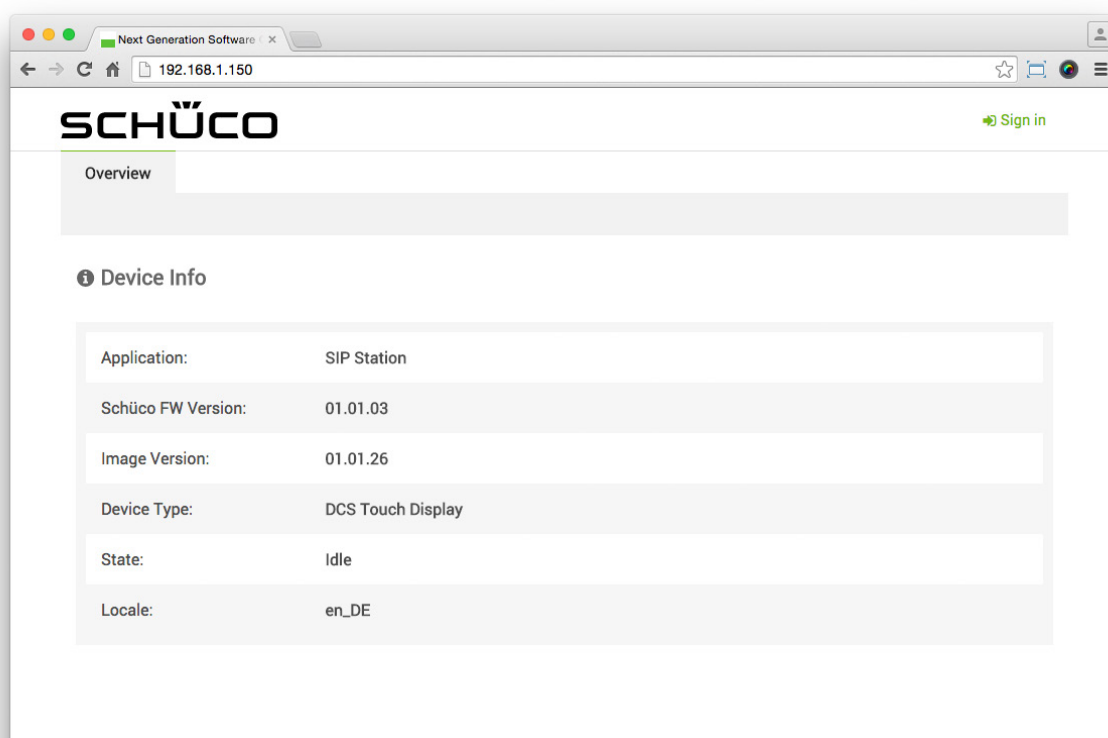
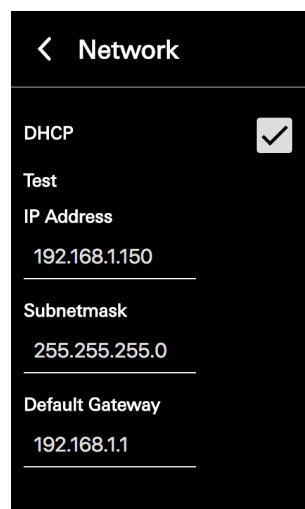

If the web interface has been called up, it already shows the most important information about the DCS Touch Display on the „Overview“ page.

The following information is available in the „Device information“ section:

- Application: The name of the intercom station is shown here („SIP station“).
- Schüco FW version: The official software version of the DCS Touch Display is shown here.
- Image version: The image of the official software version of the DCS Touch Display is shown here.
- Device type: The type of intercom station is shown here („DCS Touch Display“).
- Status: The current operating mode of the intercom station is shown here.
- Locale: The current settings for language and country are shown here.

9.3. Logging in

You must log in to the web interface in order to make changes to the DCS Touch Display. The „Login“ page appears when you click on „log in“ in the top right-hand corner of the window. To return to the „Overview“ page, click on „Overview“ or on the Schüco logo on the left in the web interface.

The standard administrator access data for the web interface is:

Username: admin
Password: schueco



INFORMATION

Access data

Contact your system administrator if the administrator access data has been changed or you have been issued personal access data.

After successfully logging in as administrator, the message „You are logged in as administrator“ appears.

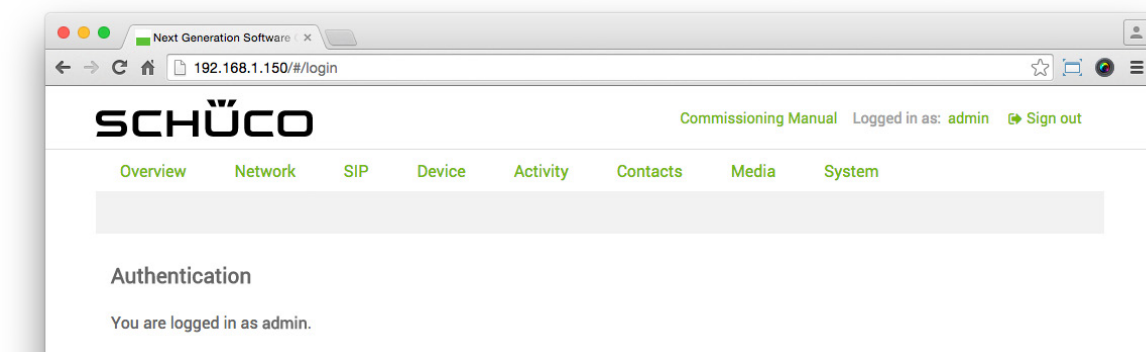

9.4. Configuration

The menu bar of the web interface is subdivided into the following sections in order to enable user-friendly and intuitive operation:

- Overview: View the most important data and settings.
- Network: Make IP network settings.
- SIP: Make SIP settings.
- Device
 - Device: Make display settings for the screen.
 - Audio: Make audio settings.
 - Video: Make video streaming settings.
 - Motion detection: Configuration of motion detection for the internal camera.
 - Buttons: Make settings for the „Doorbell list“ view.
- Activity
 - Activity: Make settings for the triggering of action sequences.
 - Action sequences: Make settings for actions.
- Contacts: Manage contacts.
- Media
 - Tones: Manage audio media.
 - Photos: Manage image media.
- System
 - System: Make system settings.
 - User administration: Make settings for user accounts.
 - Codes: Make settings for audio and video codes.
 - Remote maintenance: Start remote maintenance for support purposes.

In addition, there are the following options above the menu bar:

- Schüco (company logo): Tapping here calls up the „Overview“ page (see „9.6 Overview“).
- Commissioning instructions: Tapping here calls up these instructions, which are stored on the Schüco homepage.
- Logged in as: (user name): This shows which user is currently logged in. Clicking on the user name (e.g. „admin“) immediately calls up the „User administration“ page, on which the profile can be edited (see „9.18.2 Profile“).
- Log out: By tapping here, the user currently logged in can log out.

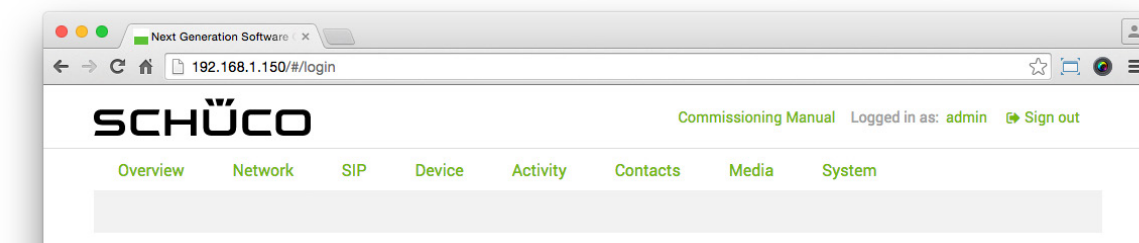



INFORMATION

Action sequences and activities

Action sequences and activities can be differentiated as follows: An action sequence allows a logical command sequence to be defined, through which particular functions can be activated - e.g. actuating a door opener (see „9.14 Action sequences“). An activity, on the other hand, allows a trigger to be defined, which automatically performs an action sequence - e.g. in the event of an error (see „9.13 Activity“).

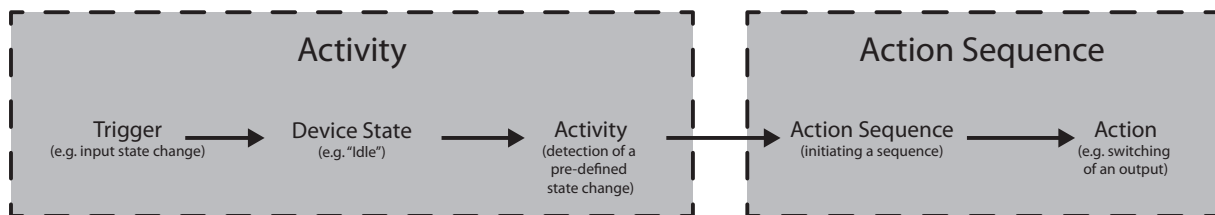

9.5. Message boxes

The web interface displays message boxes in the form of change notices, confirmation messages or error messages in the bottom part of the browser.

As soon as a configuration shows changes, a message box appears with a change notice.





INFORMATION

Applying changes

Changes are not saved automatically. The DCS Touch Display only applies the settings made once the „Save“ button is clicked.



 Save Click on this button to apply all changes.

 Discard Click on this button to discard all changes.

Once a change has been successfully saved, a message box with a confirmation message appears (e.g. changes successfully saved or picture uploaded).



As soon as an error has been detected, a message box with an error message appears (e.g. connection errors, incorrect configuration or server errors).



9.6. Overview when logged in

The most important information about hardware and software is displayed on the „Overview“ page. All details on this page are for information purposes only and cannot be amended.

The following information is available in the „Device information“ section:

- Application: Displays name of the intercom station („SIP station“).
- Schüco FW version: Displays the official software version of the DCS Touch Display.
- Image version: Displays the image of the official software version of the DCS Touch Display.
- Version: The software version of the DCS Touch Display is shown.
- Device type: The type of intercom station is shown („DCS Touch Display“).
- Status: The current operating mode of the intercom station is shown.
- Locale: The current settings for language and country are shown.

The following information is available in the „Network status“ section:

- MAC address: The MAC address of the DCS Touch Display is shown.
- DHCP: This shows whether or not the DHCP function (automatic IP address assignment) is activated.
- IP address: The IP address of the DCS Touch Display is shown.
- Subnet mask: The subnet mask of the DCS Touch Display is shown.
- Default gateway: The IP address of the default gateway for the router is shown.
- Preferred DNS server: The IP address of the primary DNS server is shown.
- Alternative DNS server: The IP address of the secondary DNS server is shown.

The following information is available in the „SIP server“ section:

Here you are shown how many SIP servers have been created and whether a connection to these exists.

The screenshot shows a web browser window with the URL 192.168.1.150/#. The page header includes the Schüco logo, a 'Commissioning Manual' link, and user information 'Logged in as: admin' with a 'Sign out' button. A navigation menu contains links for Overview, Network, SIP, Device, Activity, Contacts, Media, and System. The 'Device Info' section displays the following details:

Application:	SIP Station
Schüco FW Version:	01.01.03
Image Version:	01.01.26
Device Type:	DCS Touch Display
State:	Idle
Locale:	en_DE

The 'Network State' section provides the following network configuration:

MAC Address:	E2:34:6F:29:E8:4D
DHCP:	disabled
IP Address:	192.168.1.150
Subnetmask:	255.255.255.0
Default Gateway:	192.168.1.1
Preferred DNS Server:	192.168.170.2
Alternate DNS Server:	192.168.170.1

The 'SIP Servers' section lists one server:

1. SIP1234@example.example.com:5060 Unregistered

9.7. Network

On the „Network“ page, it is possible to make all relevant settings in order to integrate the DCS Touch Display into the building's existing network.

The following options are available in the „Network settings“ section:

- DHCP activated: Check this checkbox to automatically request the necessary IP settings from the DHCP server. While this checkbox is checked, settings in the fields „IP address“, „Subnet mask“, „Default gateway“, „Preferred DNS server“ and „Alternative DNS server are ignored.
- MAC address: The MAC address of the DCS Touch Display is shown here (cannot be changed).
- IP address: Enter the IP address of the DCS Touch Display (is only needed when the „DHCP activated“ checkbox is unchecked).
- Subnet mask: Enter the network mask which belongs to the IP address (is only needed when the „DHCP activated“ checkbox is unchecked).
- Default gateway: Enter the IP address of the router or default gateway (is only needed when the „DHCP activated“ checkbox is unchecked).
- Preferred DNS server: Enter the IP address of the primary DNS server (is only needed when the „DHCP activated“ checkbox is unchecked).
- Alternative DNS server: If necessary, enter a second IP address for the secondary DNS server (is only needed when the „DHCP activated“ checkbox has been unchecked and an IP address has been entered in the field „Preferred DNS server“).
- STUN server activated: Check this checkbox to activate the STUN function (Session Traversal Utilities for NAT).
- STUN server IP address/host name: Enter the IP address or the host name of the STUN server.
- STUN server port: Enter the port number for the address entered in the „STUN server IP address/host name“ field.



INFORMATION

Changes to the IP address

In the event of a change to the IP address of the DCS Touch Display, the web interface must be called up again with the new IP address. Therefore, if necessary make a note of the new address before saving to enable you to call up the web interface again.

What is STUN?

„Session Traversal Utilities for NAT“ is a network protocol, which detects firewalls and penetrates NAT routers. With the aid of this protocol, SIP devices, amongst others, can receive data from the internet within a building's network without any complications.

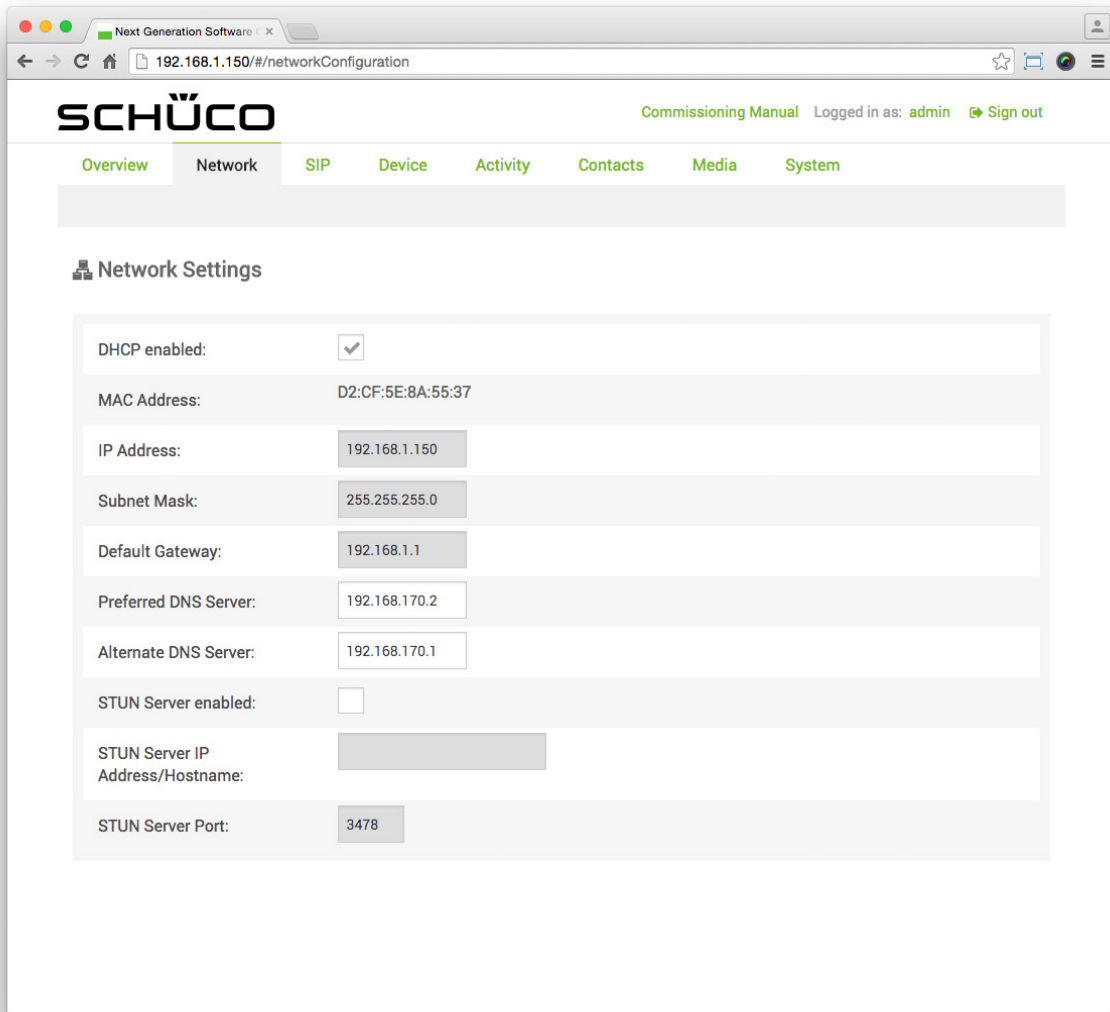

9.8. SIP

On the „SIP“ page, it is possible to make all relevant settings in order to connect the DCS Touch Display to an SIP server.

The screenshot shows a web browser window with the URL 192.168.1.150/#/sip. The page header includes the Schüco logo, a 'Commissioning Manual' link, and a 'Logged in as: admin' status with a 'Sign out' button. A navigation menu contains 'Overview', 'Network', 'SIP', 'Device', 'Activity', 'Contacts', 'Media', and 'System'. The 'SIP Settings' section contains three input fields: 'Display Name' (DCS Touch), 'Local SIP-Port' (5060), and 'Local RTP Port' (16384). Below this is the 'SIP Servers' section, which lists one server: '1. SIP1234@example.example.com:5060' with a 'Registered' status and a delete icon. The server configuration details include: 'Registration enabled' (checked), 'SIP Server IP Address/Hostname' (example.example.com), 'SIP Server Port' (5060), 'User ID' (SIP1234) with a help icon and the note '"user", "user@domain" or "user@domain.port"', 'Authentication ID' (empty) with a help icon and the note '"user"', 'Password' (masked with dots), and 'DTMF Mode' (Automatic). A '+ Add SIP Server' button is located at the bottom of the server list.

9.8.1. SIP settings

In the „SIP settings“ section, settings can be made which allow the Touch Display to communicate via SIP (Session Initiation Protocol).



The following options are available in the „SIP settings“ section:

- Display name: If necessary, enter text for the SIP device (caller ID).
- Local SIP port: Enter the port number for the SIP protocol („5060“ as standard).
- Local RTP port: Enter the port number for the RTP protocol („16384“ as standard).

9.8.2. SIP server

In the „SIP server“ section, settings can be made which enable a connection between the DCS Touch Display and an SIP server.

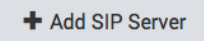
The following options are available in the „SIP server“ section:

- Registration activated: Check this checkbox to enable the registration of the SIP device with the corresponding access data to an SIP server. For serverless operation, this checkbox must be unchecked.
- SIP server IP/host name: Enter the IP or host address of the SIP server.
- SIP server port: Enter the port number for the address entered in the „SIP server IP/host name“ field.
- User ID: Enter the telephone number of the SIP account for registration at the SIP server. For some SIP servers, it is necessary to enter the domain in addition (e.g. „user_name@domain“).
- Authentication ID: Enter the authentication ID for the SIP device. This ID is only needed for certain SIP servers.
- Password: Enter the password of the SIP account for registration at the SIP server.
- DTMF mode: Click on the „DTMF mode“ selection list. Here the following options are available to you:
 - Automatic: The SIP device adjusts the signal transmission automatically.
 - RTP event (RFC2833): Signals are transmitted in accordance with protocol RFC 2833.
 - SIP information: Signals are transmitted in accordance with the SIP protocol.
-  : Click on this button to create up to two further SIP server settings areas.
-  : Click on this button to delete the current SIP server settings area.

9.8.3. SIP connection

On the right-hand side of the header in the respective SIP server settings area, you are shown whether there is a connection to the respective SIP server.

The following display options are available:

- No registrar (Peer-to-Peer): The DCS Touch Display is working without a server.

1. Registrarless (Peer-to-Peer)

Unregistered



- Registered: The DCS Touch Display is connected to an SIP server.

1. SIP1234@example.example.com:5060

Registered



- Not registered: The DCS Touch Display is not connected to an SIP server.

1. SIP1234@example.example.com:5060

Unregistered



- Connection failed: It was not possible to establish a connection between the DCS Touch Display and the SIP server.

1. SIP1234@example.example.com:5060

Connection failed



- Log off: The DCS Touch Display is logging off from the SIP server.

1. SIP1234@example.example.com:5060

Unregistering



9.9. Device

9.9.1. Device

On the „Device“ page, it is possible to make display settings for the screen of the DCS Touch Display.

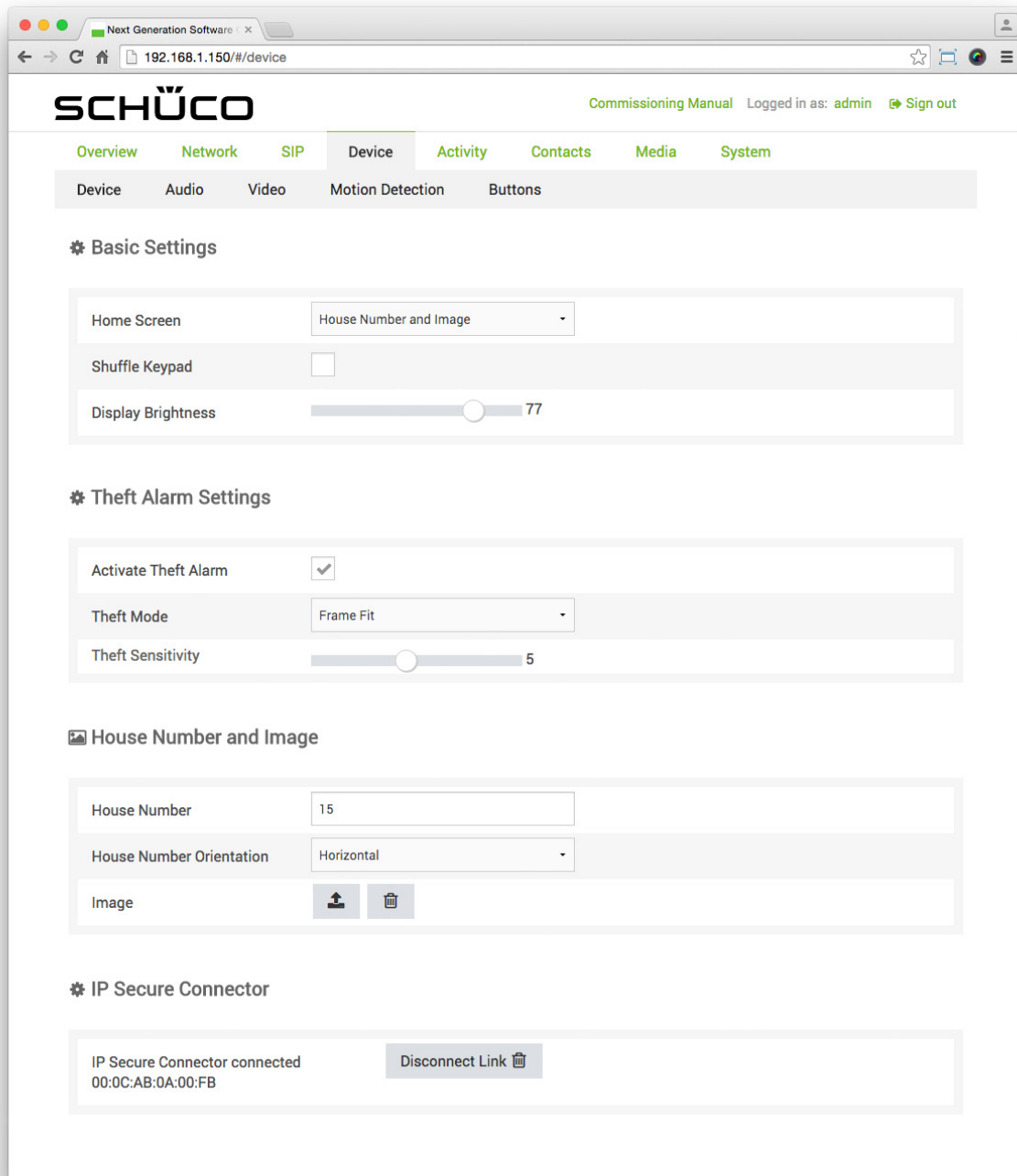

The screenshot shows a web browser window with the URL `192.168.1.150/#/device`. The page is titled "SCHÜCO" and includes a navigation menu with options: Overview, Network, SIP, Device (selected), Activity, Contacts, Media, and System. Below the navigation, there are sub-tabs: Device, Audio, Video, Motion Detection, and Buttons. The main content area is divided into several sections:

- Basic Settings:**
 - Home Screen: House Number and Image (dropdown)
 - Shuffle Keypad:
 - Display Brightness: Slider set to 77
- Theft Alarm Settings:**
 - Activate Theft Alarm:
 - Theft Mode: Frame Fit (dropdown)
 - Theft Sensitivity: Slider set to 5
- House Number and Image:**
 - House Number: 15 (text input)
 - House Number Orientation: Horizontal (dropdown)
 - Image: Upload and Delete icons
- IP Secure Connector:**
 - Status: IP Secure Connector connected
 - MAC Address: 00:0C:AB:0A:00:FB
 - Action: Disconnect Link (button)

9.9.1.1 Basic settings

In the „Basic settings“ section, basic settings can be made for the screen of the DCS Touch Display.

The following options are available in the „Basic settings“ section:

- Start screen: In this selection list, choose which view you want the DCS Touch Display to show in the device status „Idle“. The following options are available here:
 - House number and image
 - Contacts („Doorbell list“ view)
 - Code entry
- Mix code entry buttons: Check this checkbox, if you want the digits in the „Code entry“ view to be shown in a mixed, random order. If this checkbox is not checked, the digits are arranged in the same way as a standard telephone keypad.
- Screen brightness: Use this control to adjust the brightness of the screen on the DCS Touch Display.



INFORMATION

Mixed code entry buttons

Code entry buttons that are reshuffled each time the screen is called up make it harder to access the „Configuration“ view or stored action sequences without authorisation, since the fingerprint impressions left when the access code is entered are distributed evenly over the screen. It is therefore impossible to reproduce the access code used with the aid of these impressions.

1	2	3
4	5	6
7	8	9
<	0	OK

0	7	8
4	9	5
3	6	1
<	2	OK

9.9.1.2 Anti-theft device

The anti-theft device can be activated and configured in the „Anti-theft device“ section.



INFORMATION

Deactivating the anti-theft device

It is essential that you observe the steps for deactivating the anti-theft device prior to removal, as otherwise the alarm mode will be activated. If the DCS Touch Display is connected to an IP secure connector in the alarm mode, the network connection and the PoE+ power supply between the IP secure connector and the DCS Touch Display will be disconnected after 30 seconds when an attempt is made to remove the DCS Touch Display incorrectly. In this way, any unauthorised access from outside via this network cable is successfully prevented. To enable recommissioning of the DCS Touch Display, it must be put back in its original position and the „PAIRING“ button pressed on the IP secure connector. If necessary, the anti-theft device must be reactivated, as this function is deactivated in the alarm mode.

Activating the anti-theft device

The inclination sensor calibrates itself once the anti-theft device is activated. To avoid the DCS Touch Display switching to the alarm mode during installation, the anti-theft device should not be activated until the DCS Touch Display is installed in a fixed position.



The following options are available in the „Anti-theft device“ section:

- **Activating the anti-theft device:** Check this checkbox to activate the anti-theft device.
- **Mode:** In this selection list, select the installation position of the DCS Touch Display. Here the following options are available:
 - **Door installation:** If the DCS Touch Display is installed in a door, this option must be selected to prevent the anti-theft device from activating the alarm mode by mistake due to the movements of the door when opening and closing.
 - **Frame installation:** If the DCS Touch Display is installed in a DCS unit, a slight tilt angle is enough to activate the alarm mode (activated as standard).
- **Sensitivity:** Use this control to adjust the sensitivity to a value between „1“ and „10“ at which the alarm mode should be activated („5“ as standard).

9.9.1.3 House number and image

In the „House number and image“ section, you can determine what is to be displayed in the „House number/image“ view.

The following options are available in the „House number and image“ section:

- House number: Enter a house number in this field. In principle, a larger amount of text can also be entered in this field. However, this is scaled due to the size of the screen and is no longer legible under some circumstances.
- Alignment of the house number: In this selection list, choose how you want the text in the „House number“ field to be aligned. Here the following options are available:
 - Horizontal: The text is aligned horizontally.
 - Vertical: The text is aligned vertically.
-  : Click on this button to upload an image.
-  : Click on this button to delete an image that has already been uploaded.

Proceed as follows to upload an image:

1. Click on the  button.
2. Select the desired image and click on the „Open“ button.
3. Check whether the correct image has been uploaded and click on the „Save“ button.

INFORMATION

Image properties

To avoid black borders at the top and bottom or at the sides, only images of size 480 x 800 pixels (or a corresponding ratio) should be uploaded. The DCS Touch Display only supports images in the file formats JPG and PNG. The maximum file size is 6 MB.

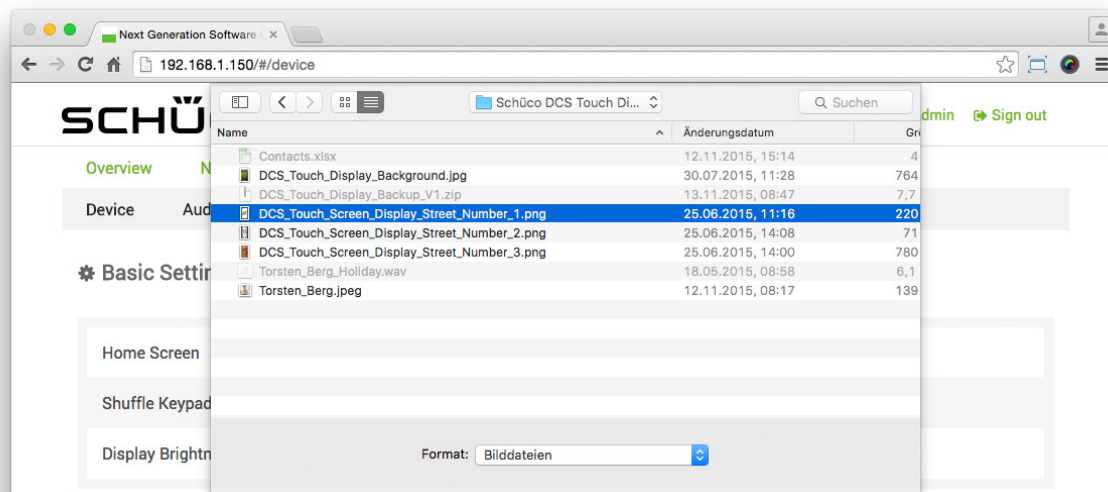

The screenshot shows a web browser window with the URL `192.168.1.150/#/device`. The page title is "SCHÜCO" and it includes a "Commissioning Manual" link and a "Logged in as: admin" status with a "Sign out" button. The navigation menu includes "Overview", "Network", "SIP", "Device" (selected), "Activity", "Contacts", "Media", and "System". Below the navigation, there are sub-menus for "Device", "Audio", "Video", "Motion Detection", and "Buttons".

* Basic Settings

Home Screen: House Number and Image (dropdown)

Shuffle Keypad:

Display Brightness: 80

* Theft Alarm Settings

Activate Theft Alarm:

Theft Mode: Frame Fit (dropdown)

Theft Sensitivity: 5

🖼️ House Number and Image

House Number:

House Number Orientation: Horizontal (dropdown)

Image:



* IP Secure Connector

IP Secure Connector connected
00:0C:AB:0A:00:FB

9.9.1.4 IP secure connector

In order to connect the DCS Touch Display to an associated IP secure connector, it is necessary to search for an IP secure connector and to connect it. If no IP secure connector is provided for the installation, you can skip this point.

The following option is available in the „IP secure connector“ section:

Find and Pair 

: Click on this button to search for an IP secure connector in the network and connect it to the DCS Touch Display. Note that the „PAIRING“ button on the IP secure connector must be pressed for a successful connection.

Disconnect Link 

: Click on this button to disconnect the connection between an IP secure connector and the DCS Touch Display.



INFORMATION

More information

More detailed information on the connection of the IP secure connector can be found in the installation instructions.

9.9.2. Audio

On the „Audio“ page, it is possible to make basic audio settings.

The following options are available in the „Audio settings“ section:

- Output volume: Adjust the output volume of the loudspeaker on the DCS Touch Display between „0“ and „12“. Microphone volume: Adjust the sensitivity of the microphone Output volume: Adjust the output volume of the loudspeaker on the DCS Touch Display between „0“ and „12“.
- Microphone volume: Adjust the sensitivity of the microphone for the DCS Touch Display between „0“ and „12“.
- Noise suppression: Check this checkbox to activate the noise suppression (deactivated as standard).
- Compressor: Check this checkbox to activate the automatic level adjustment, whereby quiet input signals (e.g. from a telephone or an intercom station) are increased in volume (deactivated as standard).
- Noise suppression: Check this checkbox to activate the noise suppression (deactivated as standard).
- Compressor: Check this checkbox to activate the automatic level adjustment, whereby quiet input signals (e.g. from a telephone or an intercom station) are increased in volume (deactivated as standard).

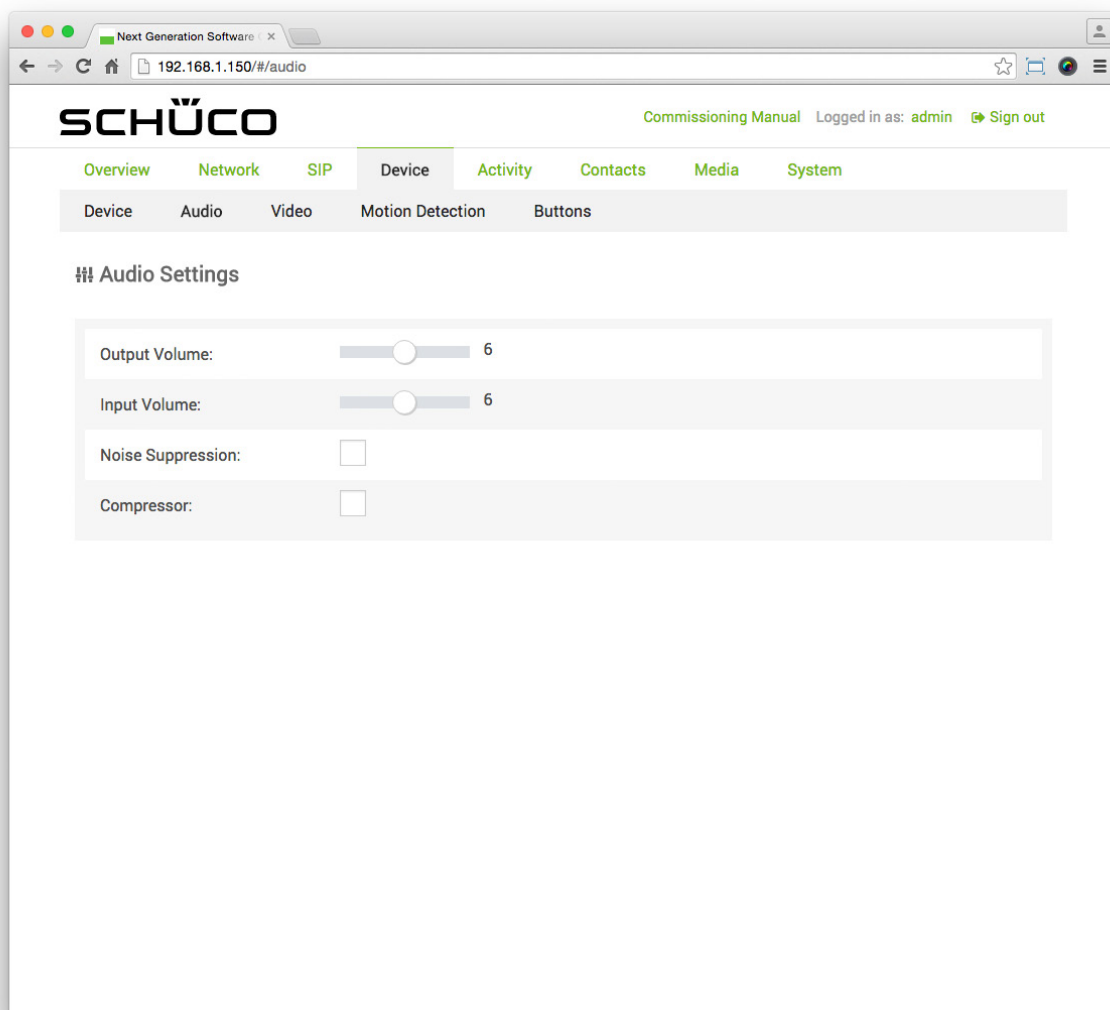

9.9.3. Video

On the „Video“ page, it is possible to make basic video streaming settings.

The following option is available in the „Video settings“ section.

- **Limit MJPEG streams:** Check this checkbox to allow video streaming only during video conversations between the DCS Touch Display and the telephone/intercom station. This prevents any unauthorised access to the camera image on the DCS Touch Display via the computer within the network (activated as standard).

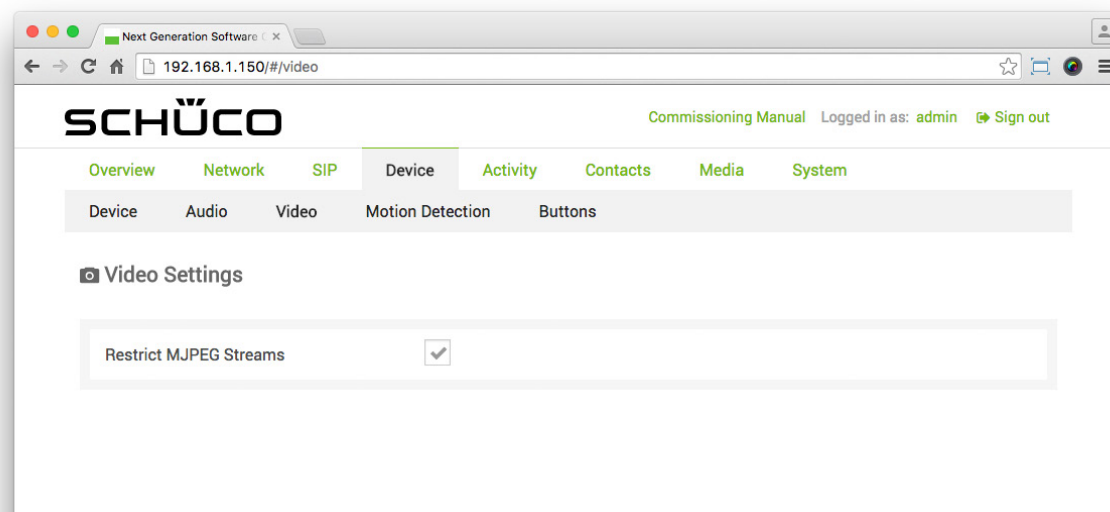

INFORMATION

Video streaming

When the checkbox „Limit MJPEG streams“ is unchecked, up to six video streaming calls can be made via the computer within one network. For this, the IP address with „/mjpeg/video.mjpg“ added to the end must be entered in the address bar of the browser. (e.g. „http://192.168.1.150/mjpeg/video.mjpg“). If the checkbox is checked, it is only possible to make a call using video streaming via a computer within a network if the DCS Touch Display is „Ringing“ or call without video is configured. The video stream is shown in the browser in the format 480 x 640 pixels.

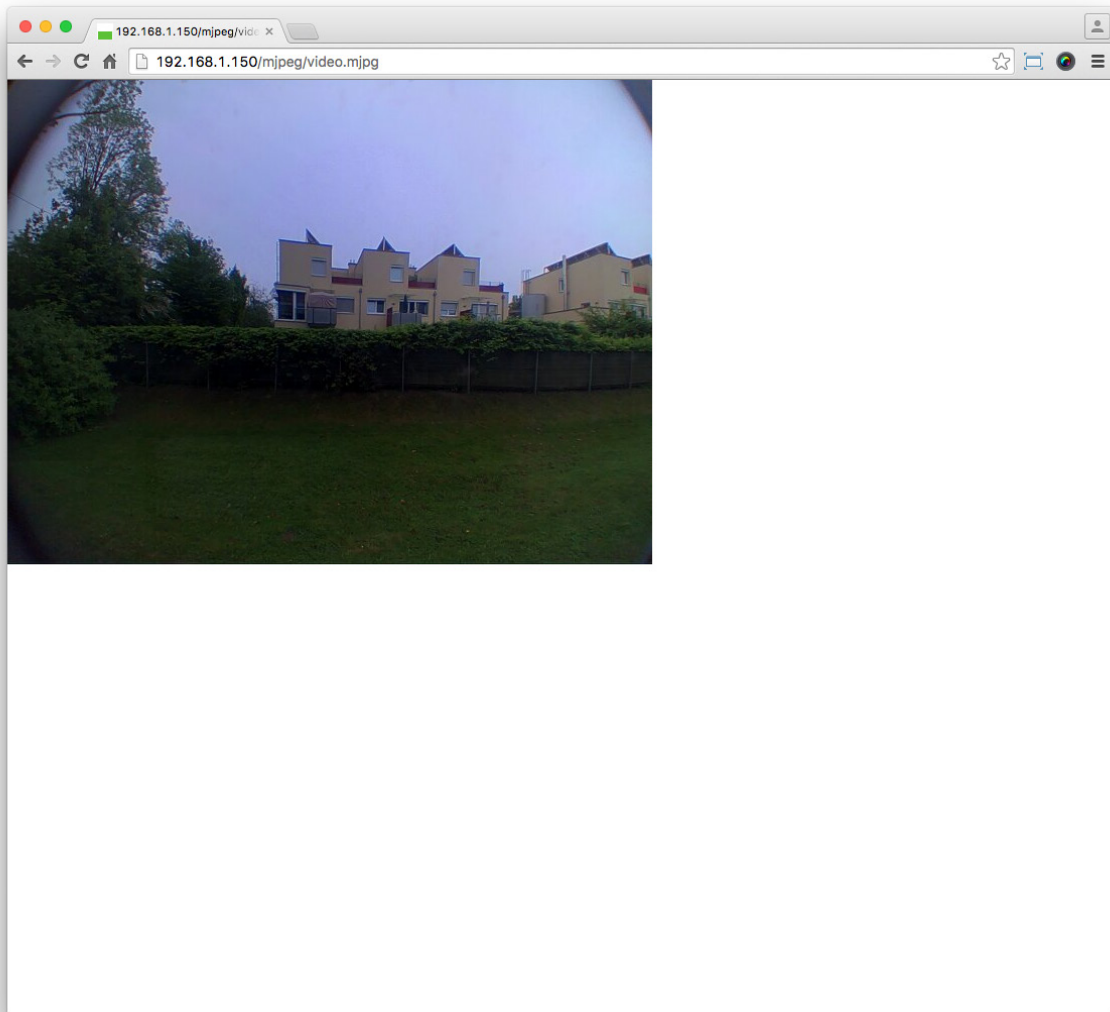

9.9.4. Motion detection

On the „Motion detection“ page, it is possible to determine the area of the camera image which is to be sensitised when the motion detection is activated.

The following options are available on the „Motion detection“ page:

- Sensitivity: Use this control to adjust the sensitivity of the motion detection of the camera on the DCS Touch Display.

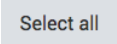
-  : Click on this button to activate the complete video image for motion detection.

-  : Click on this button to deactivate the complete video image for motion detection.

The video image on the „Motion detection“ page is shown in real time. Here there is a grid of 12 x 16 boxes, which can all be activated individually for motion detection.

There are two options for the boxes:

- Normal brightness and green border: The box or the area is activated for motion detection.
- Darkened and no border: The box or the area is deactivated for motion detection.



INFORMATION

Activating boxes for motion detection

For best results, only activate boxes in the area of the video image in which a movement can only be detected when a person approaches the DCS Touch Display. If necessary, deactivate boxes in the area of the video image in which a road, trees or other movements that are undesirable for motion detection may be detected.

Proceed as follows to activate boxes for motion detection:

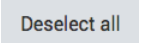
1. Click on  .
2. Click on the boxes that you want to activate. Alternatively, you can also use the cursor to select an area in which you want to activate boxes.

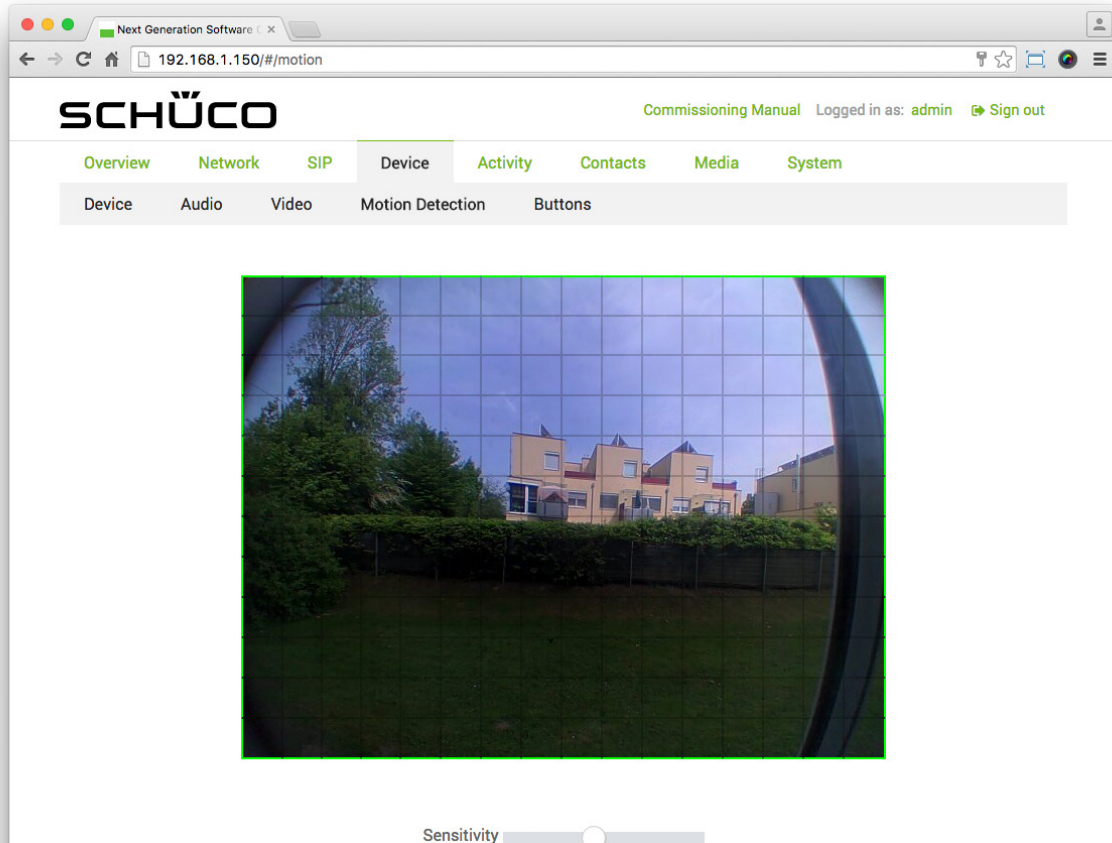

3. Adjust the sensitivity of the motion detection via the „Sensitivity“ control.

4. Click on  Save .

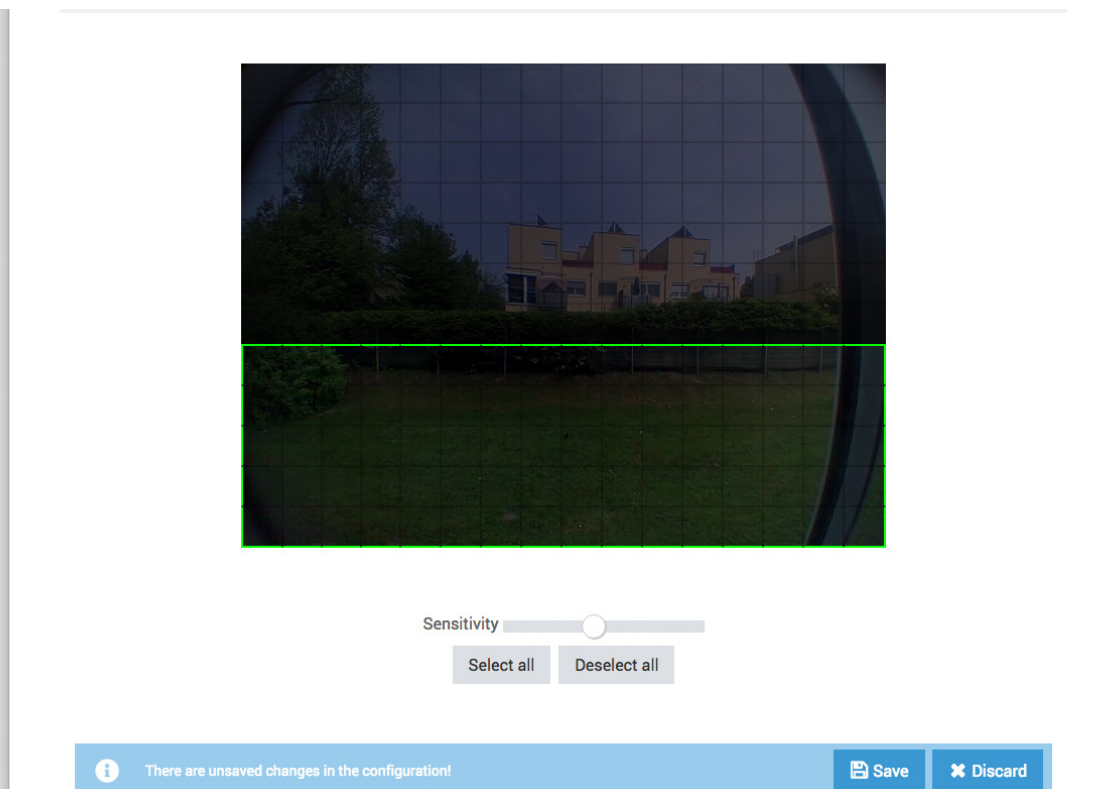

9.9.5. Buttons

On the „Buttons“ page, it is possible to make settings for the „Doorbell list“ view to enable you to initiate a call to a contact or start an action sequence, for example.









INFORMATION

Doorbell list

If no buttons have been configured on the „Buttons“ page, it is only possible to switch between the „Start screen“ and „Code entry“ views on the DCS Touch Display screen before entering the access code (the „Doorbell list“ is not displayed).

The following options are available in the „Buttons“ section:

- **First Name** : Click on this button to sort the buttons (contacts) by first name.
 -  : If the arrow is pointing upwards, the buttons are sorted alphabetically in ascending order.
 -  : If the arrow is pointing downwards, the buttons are sorted alphabetically in descending order.
- **Last Name** : Click on this button to sort the buttons (contacts) by surname.
 -  : If the arrow is pointing upwards, the buttons are sorted alphabetically in ascending order.
 -  : If the arrow is pointing downwards, the buttons are sorted alphabetically in descending order..
- **+ ADD** : Click on this button to add a new button.
-  : Click on this button to delete the desired button.
- **First name:** Enter the first name of the contact in this field. When selecting a contact, it is also possible to copy over this line of text automatically.
- **Surname:** Enter the surname of the contact in this field. When selecting a contact, it is also possible to copy over this line of text automatically.
- **Company mode:** Check this checkbox to have the contact or action sequence displayed in company mode. Here the fields „First name“ and „Surname“ are not displayed on the screen of the DCS Touch Display and the profile picture (e.g. company logo) is displayed in the centre.
 -  : Click on this button to upload a profile picture. When selecting a contact, it is also possible to copy over the corresponding profile picture automatically.
 -  : Click on this button to delete the corresponding profile picture.
- **Action or action sequence:** Select the desired action or action sequence.

The following options are available for this:

 - **Play audio file:** Here an audio file is played which has already been uploaded via the „Media“ page.
 - **Output:** Here an output (relay) on the DCS Touch Display („DCS Touch Display - OUT 1“ or „DCS Touch Display - DC-OUT 2“) or IP secure connector („IP secure connector - OUT 1“, „IP secure connector - OUT 2“ or „IP secure connector - DC-OUT 3“) is switched.
 - **Send e-mail:** Here an e-mail is sent from the contact which was configured on the „System“ page. **End conversation:** Here the current call is ended.

- Logout: Here the user currently logged in is logged out.
- Mute microphone: Here the microphone signal is muted.
- Call: Here a call is initiated to a contact which has already been created on the „Contacts“ page.
- Accept call: Here an incoming call is answered.
- Snapshot: Here a picture is taken using the built-in camera. This can be displayed on the „Media“ page. Send DTMF tone: Here a DTMF tone is sent to an SIP-compatible intercom station or an SIP telephone.
- Play location report to counterpart intercom station: This option currently has no function.
- Delayed action: Here a specific action sequence is only started after a defined period of time has elapsed.
- Switch video: This option currently has no function.
- Show view: Here the screen of the DCS Touch Display switches to a configurable view.
- Show symbol: Here a configurable symbol is shown on the screen of the DCS Touch Display.



INFORMATION

Action sequences

It is also possible to select an action sequence in the „Action or action sequence“ selection list which was previously created on the „Action sequence“ page.

The screenshot displays the Schüco web interface for configuring buttons. The main navigation bar includes 'Overview', 'Network', 'SIP', 'Device', 'Activity', 'Contacts', 'Media', and 'System'. The 'Buttons' section is active, showing a list of buttons with columns for 'First Name' and 'Last Name'. The buttons listed are Diana Huber, Katja Schmid, Matthias Köhler, Peter Bader, Philipp Schuhmacher, and Torsten Berg. The 'Torsten Berg' button is expanded to show a profile picture, input fields for 'First Name' (Torsten) and 'Last Name' (Berg), a 'Company Mode' checkbox, and an 'Action or Action Set' dropdown menu set to 'Call'.

9.9.5.1 Adding a new contact to the doorbell list

Call destinations, which have been entered on the „Contacts“ page, are not displayed automatically in the „Doorbell list“ view. Consequently it is possible to manage contacts without having to delete them on the „Contacts“ page in the event that they are temporarily not used (e.g. during an absence). In this example, you are shown how to add a contact in the „Doorbell list“ view.



INFORMATION

Contacts in the doorbell list

To be able to add contacts to the „Doorbell list“ view, it is a prerequisite that at least one contact has been entered on the „Contacts“ page (see „9.15 Contacts“).

Proceed as follows to add a contact in the „Doorbell list“ view:

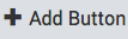
1. Click on  . The „New button“ area appears.

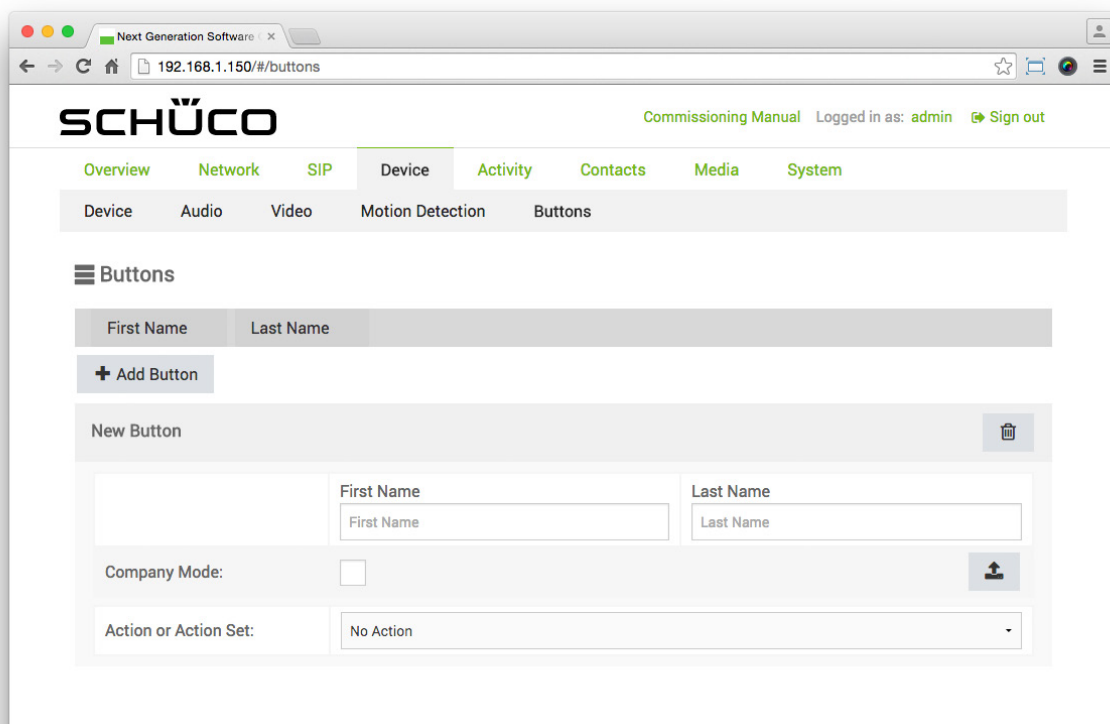
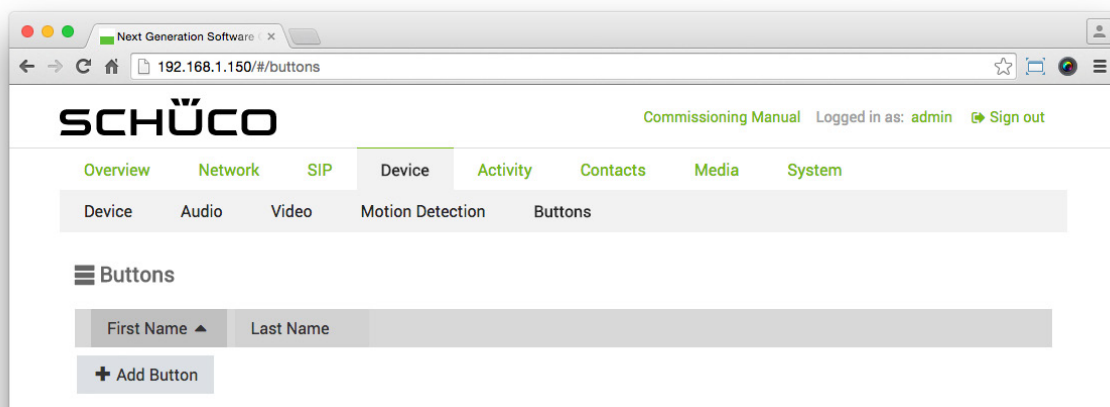

2. Wählen Sie in der Auswahlliste „Aktion oder Aktionssequenz“ die Option „Ruf“ aus.

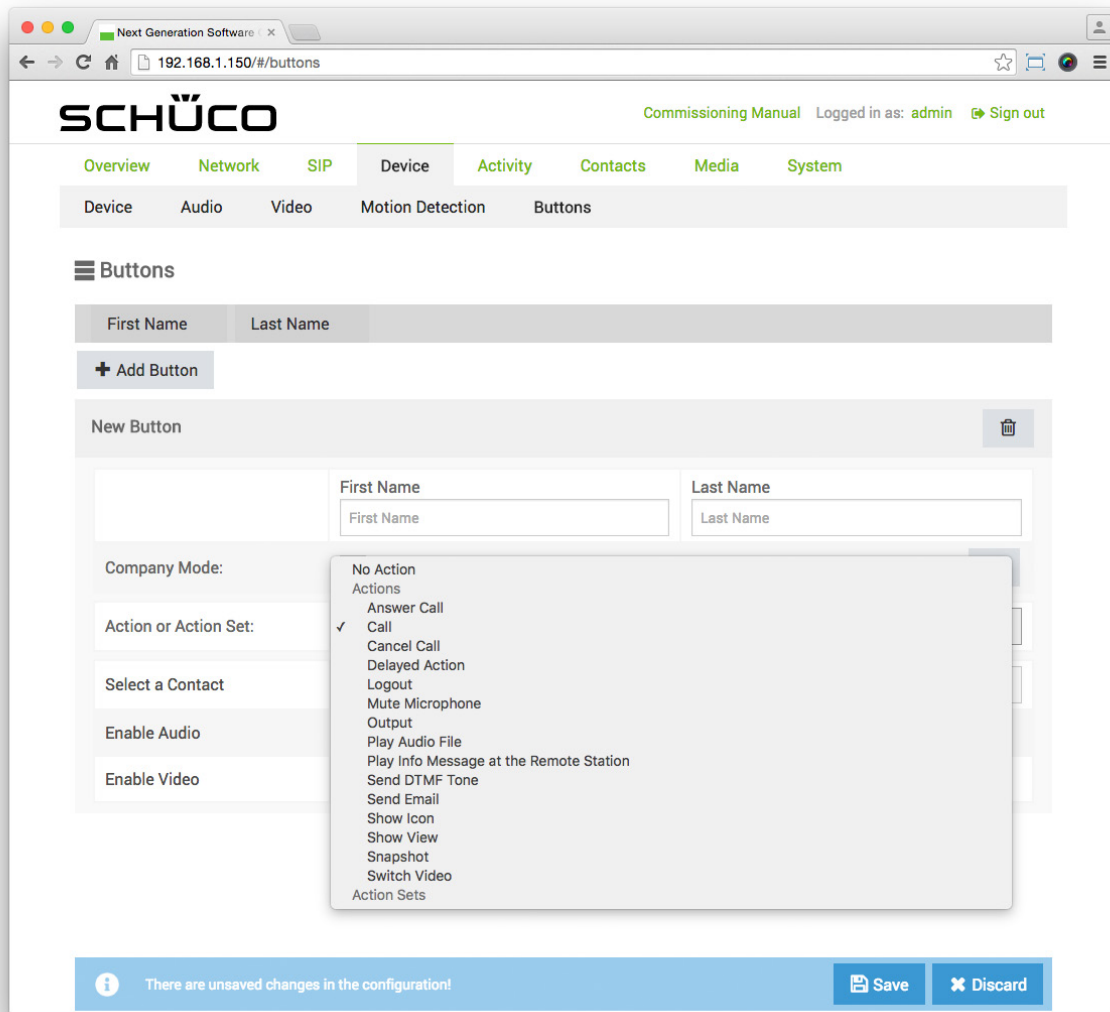

The screenshot shows the Schüco web interface for configuring buttons. The browser address bar shows `192.168.1.150/#/buttons`. The page title is "SCHÜCO" and the user is logged in as "admin". The navigation menu includes "Overview", "Network", "SIP", "Device", "Activity", "Contacts", "Media", and "System". The "Device" tab is active, and the "Buttons" sub-tab is selected. The "Buttons" section has a table with columns "First Name" and "Last Name", and an "Add Button" button. Below this is the "New Button" form, which includes fields for "First Name" and "Last Name", and a "Company Mode" dropdown. The "Action or Action Set" dropdown is open, showing a list of actions: "No Action", "Actions", "Answer Call", "Call", "Cancel Call", "Delayed Action", "Logout", "Mute Microphone", "Output", "Play Audio File", "Play Info Message at the Remote Station", "Send DTMF Tone", "Send Email", "Show Icon", "Show View", "Snapshot", "Switch Video", and "Action Sets". The "Call" option is selected with a checkmark. At the bottom of the page, there is a blue notification bar that says "There are unsaved changes in the configuration!" and two buttons: "Save" and "Discard".

3. In the „Select contacts“ selection list, select the desired contact. The „Overwrite settings?“ dialog box appears.

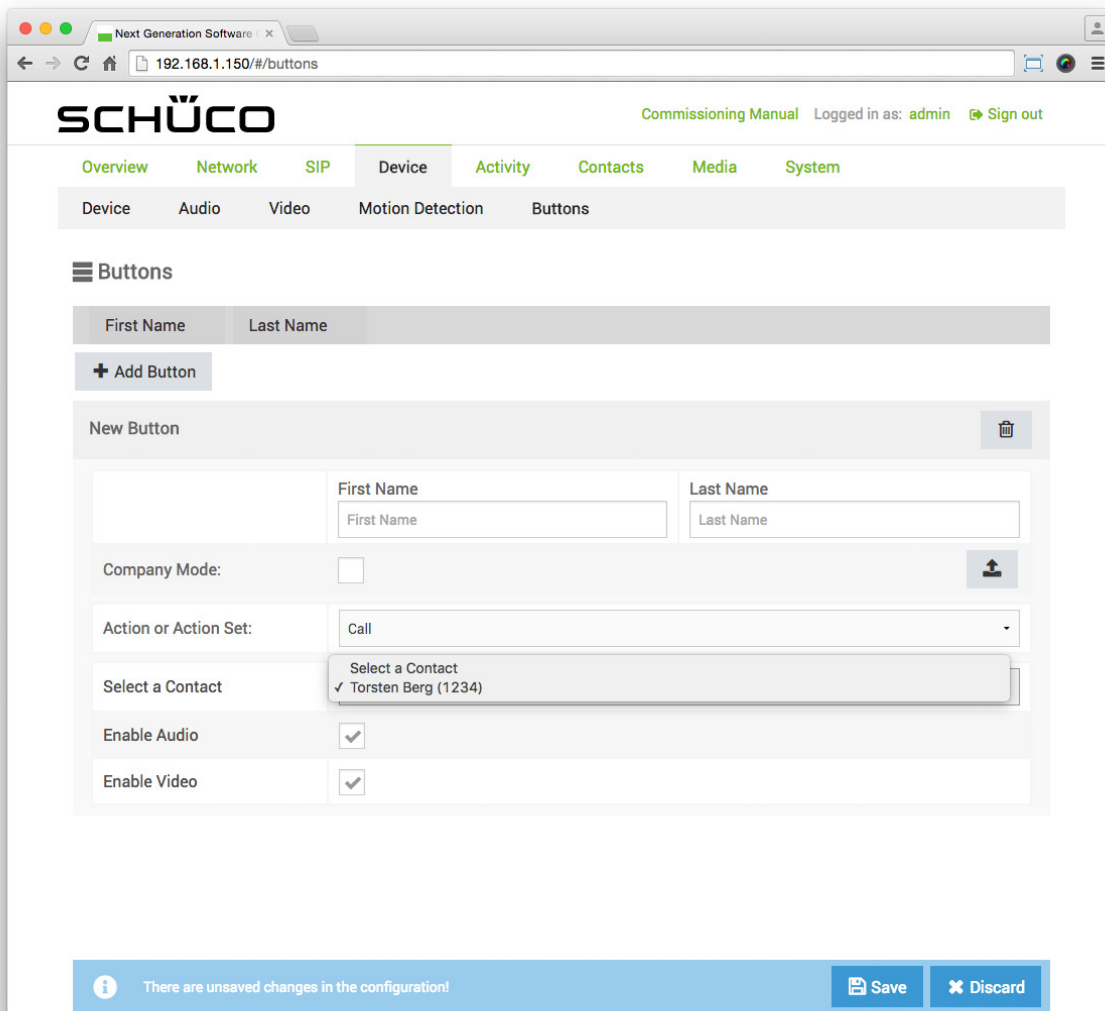

4. Click on „Yes“ to automatically copy over the fields „First name“ and „Surname“ as well as the profile picture of the contact.

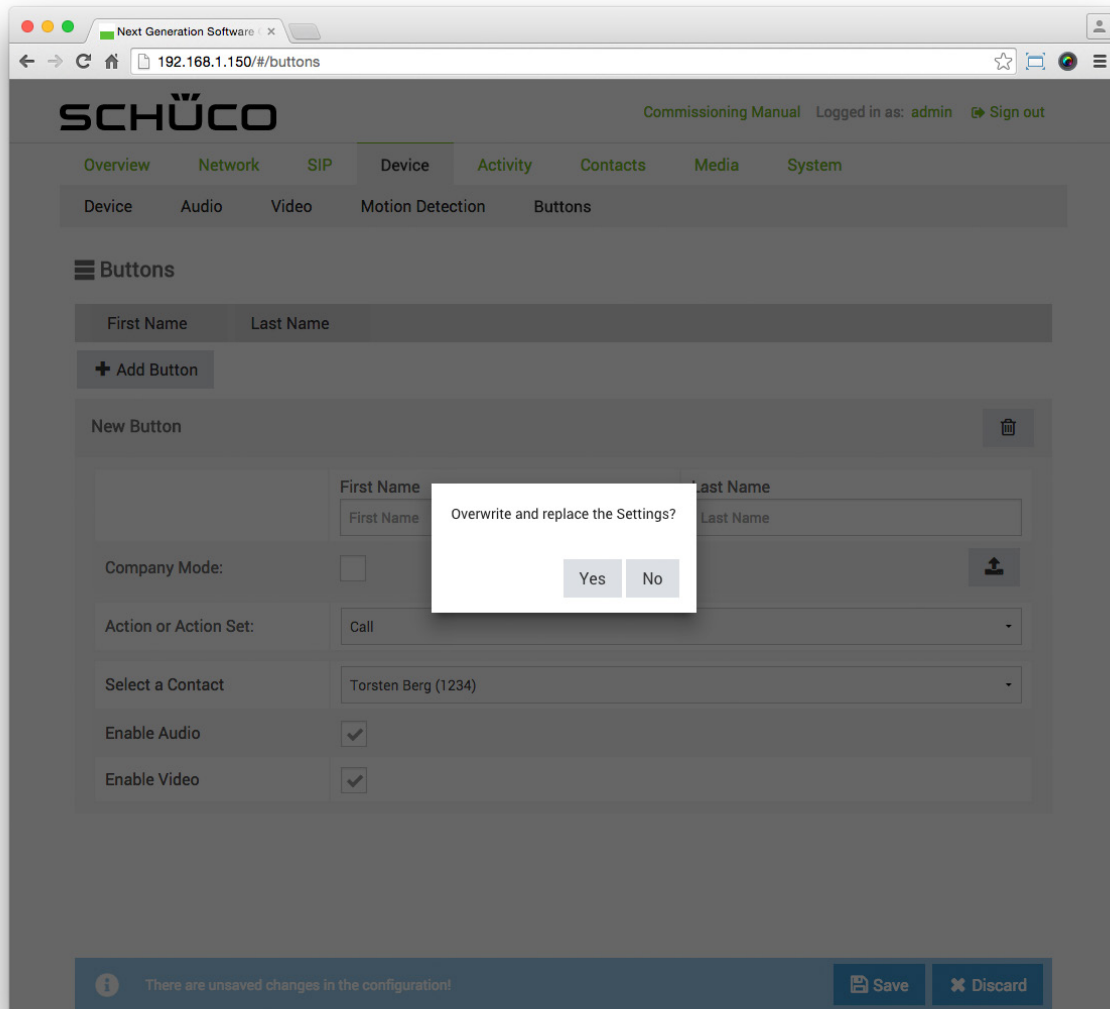

- 5. Ensure that the checkboxes „Activate audio“ and „Activate video“ are checked to enable audio and images for a call. If you do not want to use video transmission, uncheck the „Activate video“ checkbox.

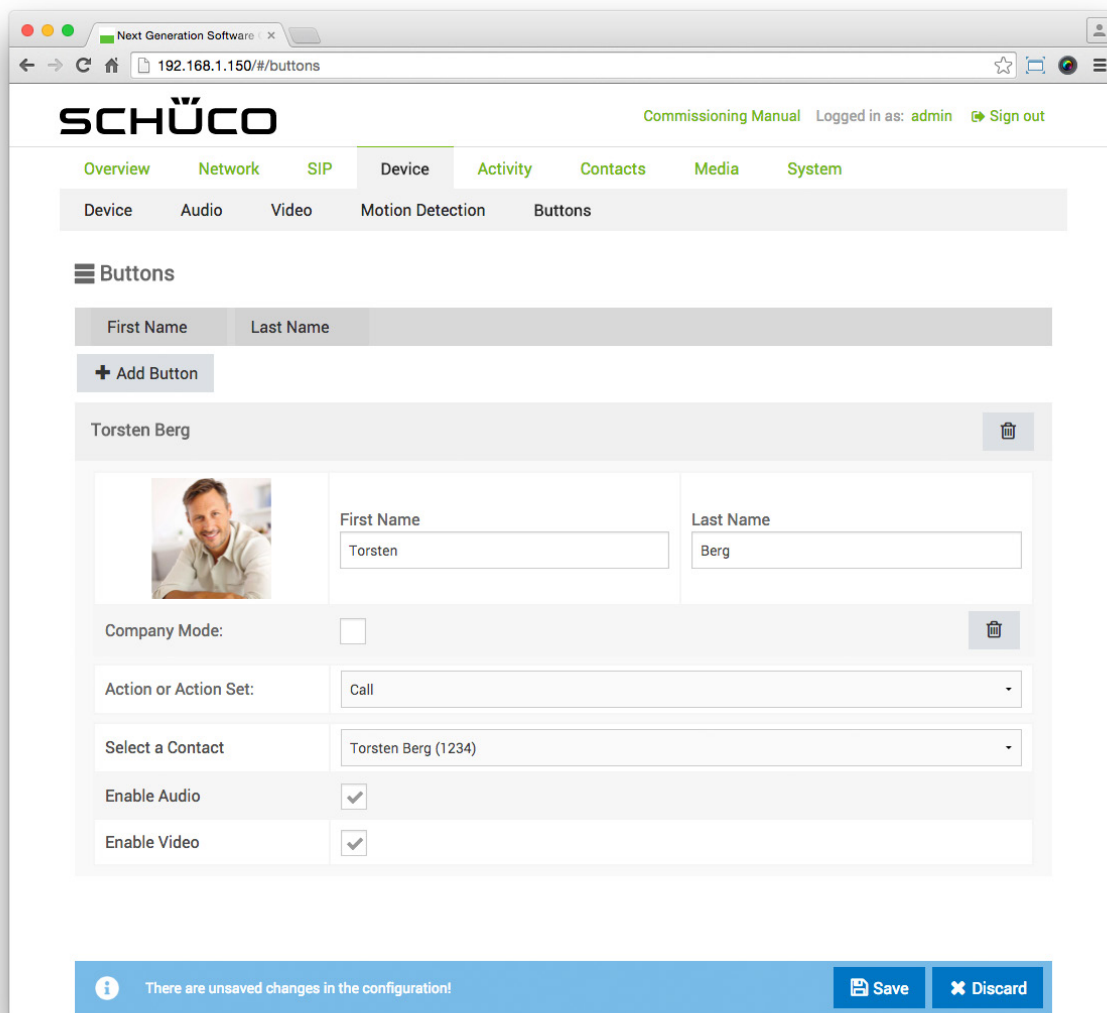

- 6. Click on  Save .

In the „Action or action sequences“ selection list, particular actions can be selected. The following example will help to explain how an audio file previously uploaded on the „Media“ page can be played when trying to call a contact using the DCS Touch Display. The aim here is to store an audio file for a contact that has already been created which informs a visitor that the contact is currently on holiday.



INFORMATION

Uploading an audio file

More detailed information about uploading audio files can be found under „9.16.1 Adding an audio file“.

To store an audio file for a contact, proceed as follows:

1. Click on the field of the button already created to open the settings area.

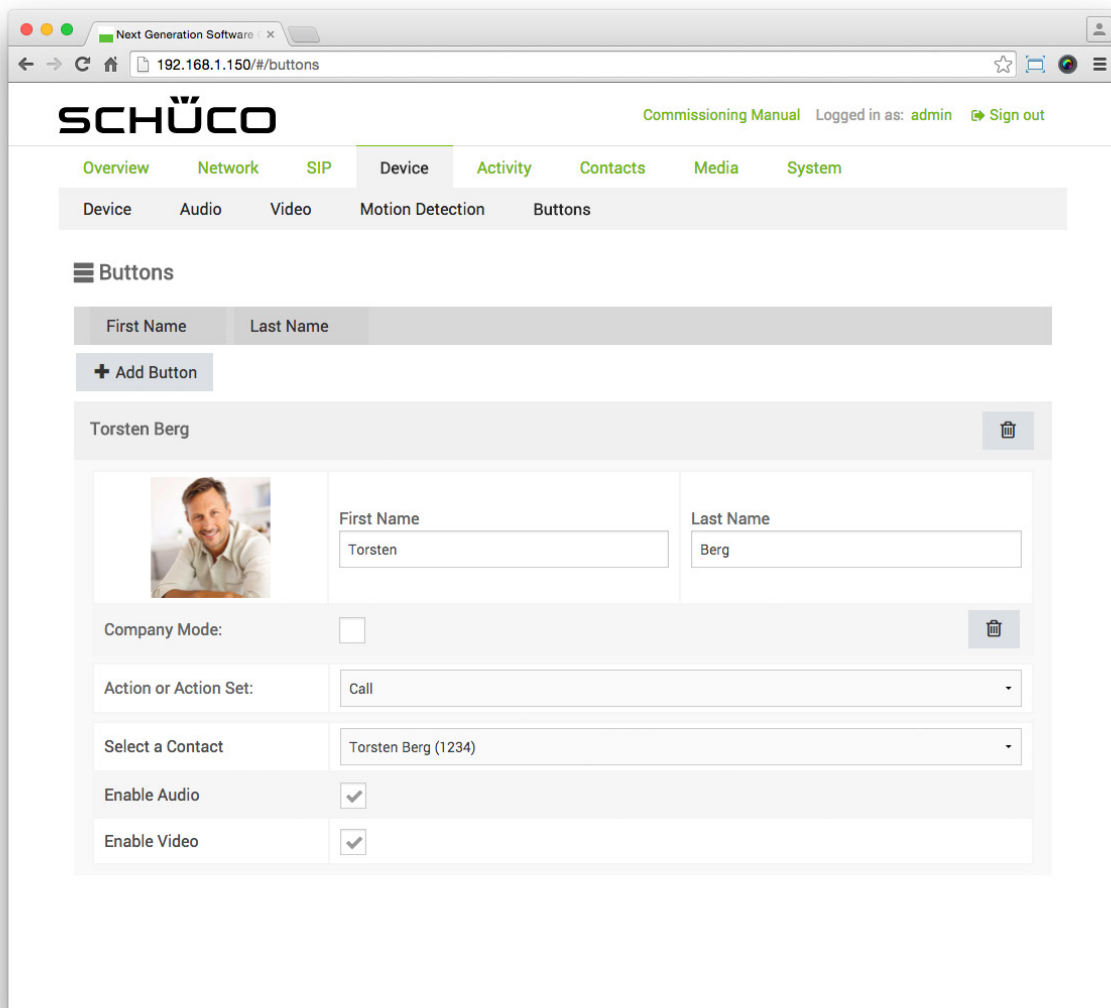

2. In the „Action or action sequence“ selection list, select the „Play audio file“ option.

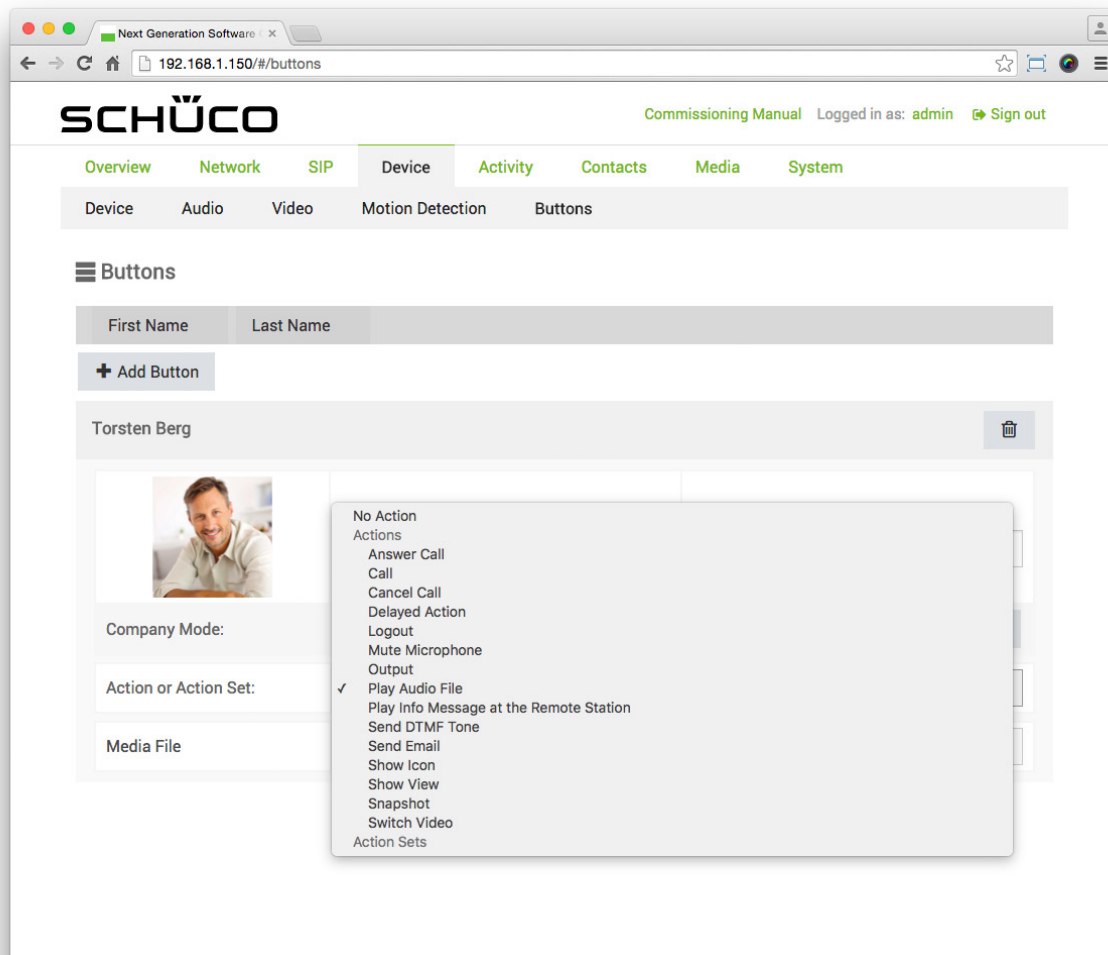

3. In the „Media file“ selection list, select the corresponding audio file option.

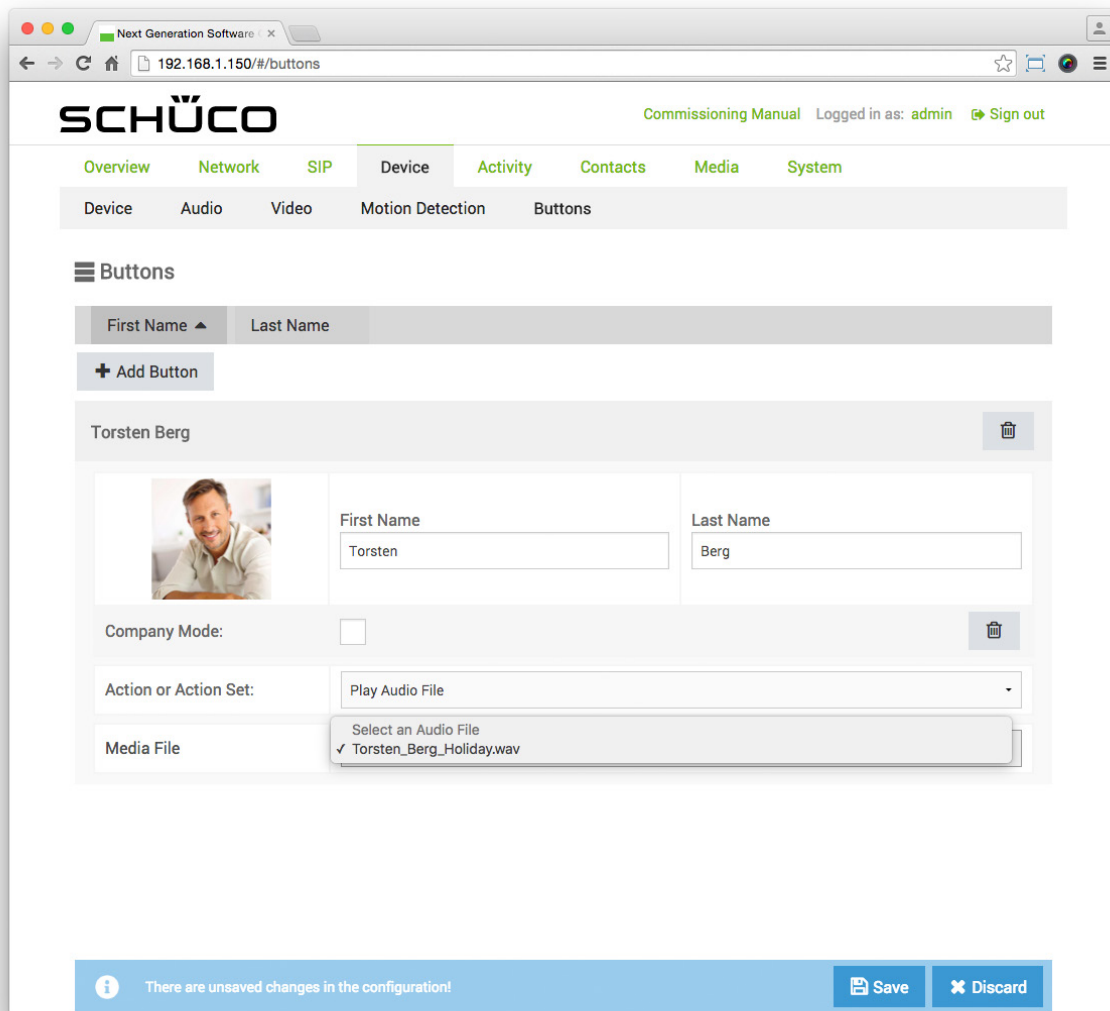

4. Click on  Save.

9.9.5.2 Adding an action sequence

On the „Buttons“ page, previously configured action sequences can be selected in the „Action or action sequence“ selection list. The following example will help to explain how an action sequence is created on the „Action sequences“ page and how this is then stored on the „Buttons“ page with a new button. The aim here is to create a button for opening the entrance door in the „Doorbell list“ view which only ever actuates the door opener between 9:00 and 18:00 from Monday to Friday.

To create an action sequence for a door opener and store this with a new button, proceed as follows:

1. Open the „Action sequences“ page via „Activity“.

2. Click on .

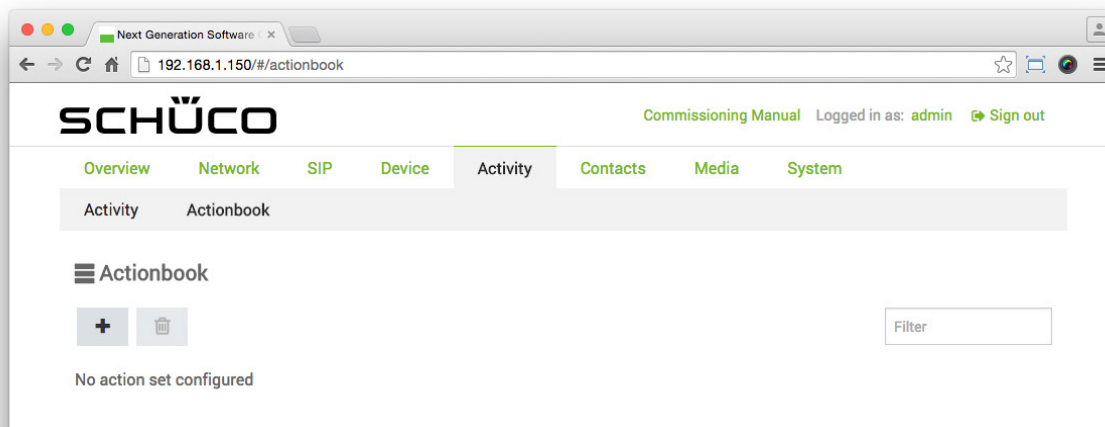

3. Enter a meaningful term or phrase for the action sequence in the „Name“ field (e.g. „Open door“).

4. Click on .

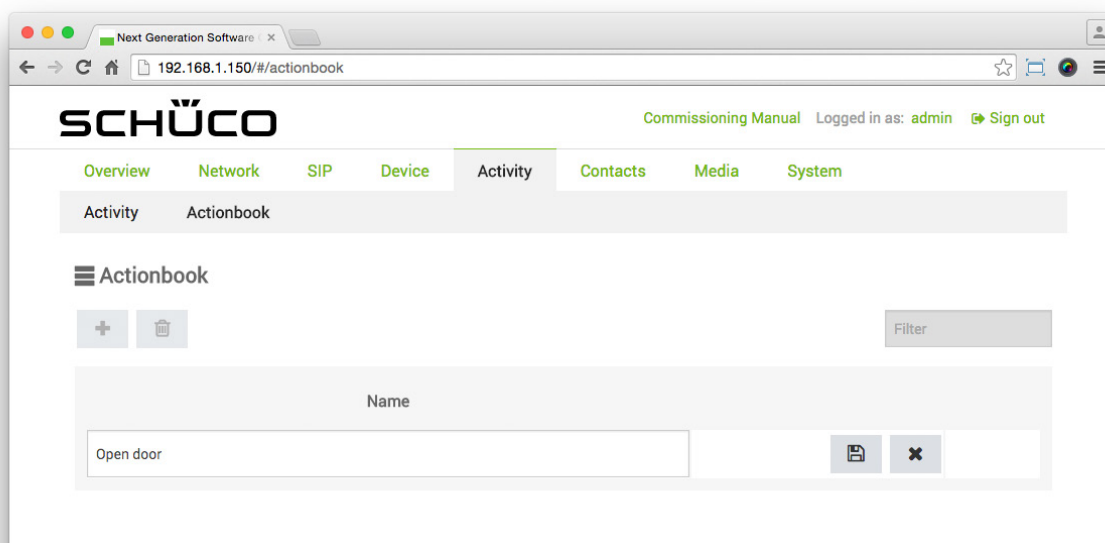



5. Click on .

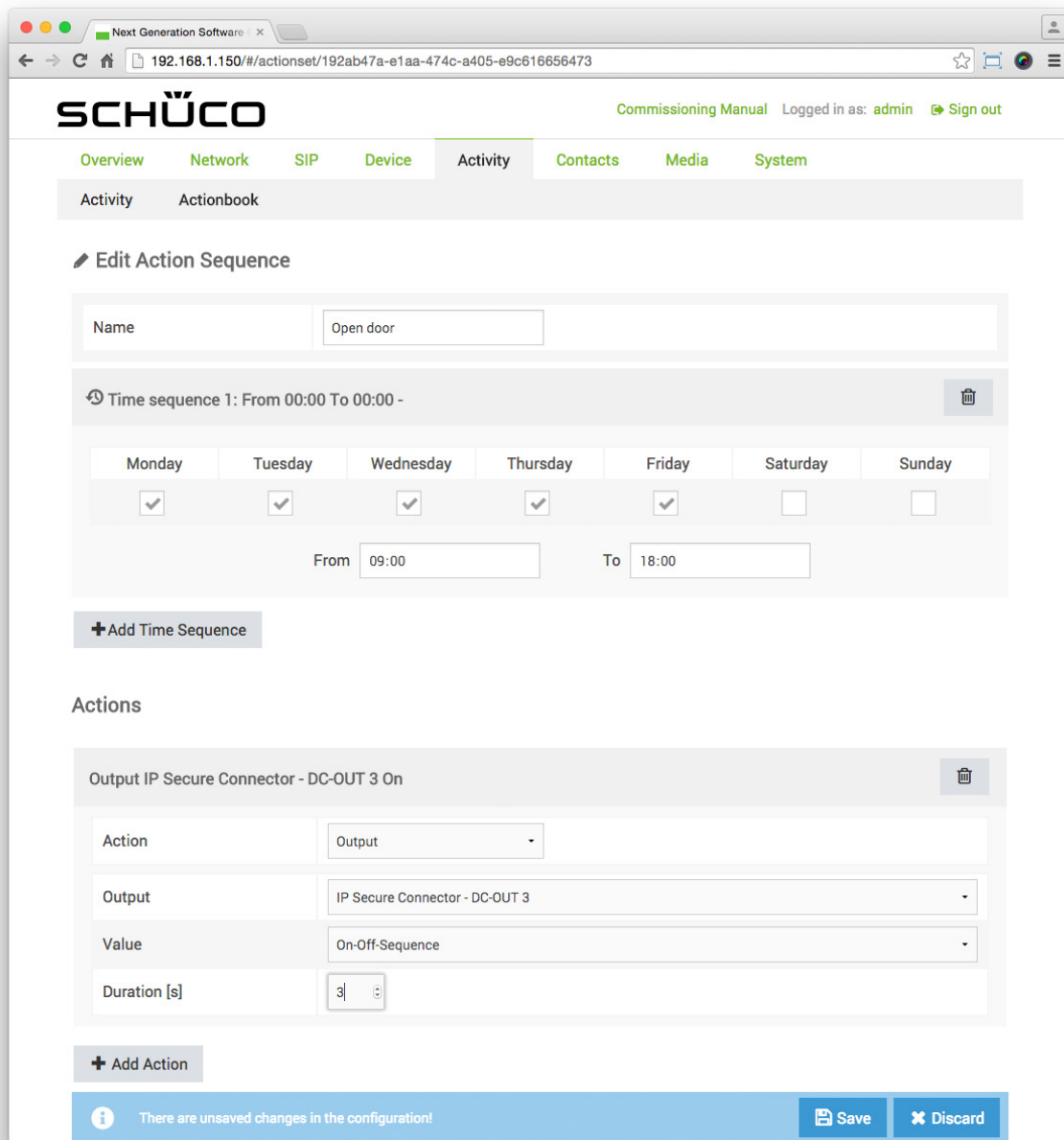

6. Click on **+ Add Time Sequence**.
7. Check the checkboxes for the days „Monday“ to „Friday“ and enter the time at which the action sequence is to be available in the fields „From“ and „To“ (e.g. from „09:00“ to „18:00“).
8. Click on **+ Add Action**.

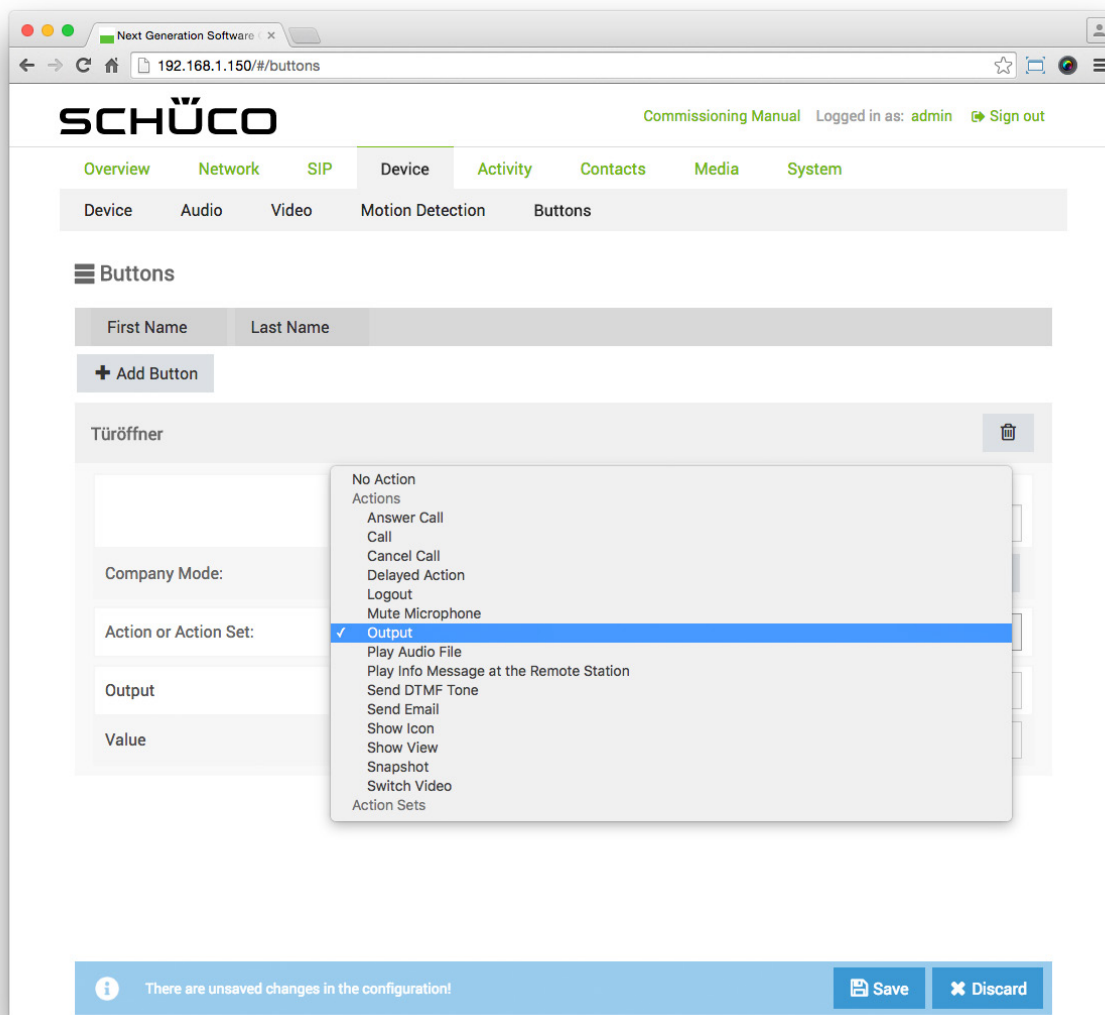

9. In the „Action“ selection list, select the „Output“ option.

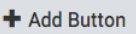

10. In the „Output“ selection list, select the output to which the door opener is connected (e.g. „DCS Touch Display - OUT1“).
11. In the „Value“ selection list, select the „On-off sequence“ option.
12. In the field „Duration [s]“, enter the time in seconds for which the door opener is to be actuated (e.g. „3“).
13. Click on  Save .
14. Open the „Buttons“ page via „Device“.
15.  Add Button Click on . The „New button“ area appears.
16. Click on the newly created area to open it.
17. In the „First name“ field, enter a meaningful name (e.g. „Door opener“). You can leave the „Surname“ field blank.

18. Click on  and upload an appropriate image, if available.
19. In the „Action or action sequence“ selection list, select the action sequence previously created (e.g. „Door opener“).
20. Click on .



9.9.5.3 Adding a contact in company mode

In company mode, contacts can be displayed „Doorbell view“ across the entire width without a name and with only an image in the. In the following example, you are shown how to add a contact to the „Doorbell list“ view in company mode.



INFORMATION

Contacts in the doorbell list

To be able to add a contact to the „Doorbell list“ view, at least one contact must be available on the „Contacts“ page.

1. Click on . The „New button“ area appears.

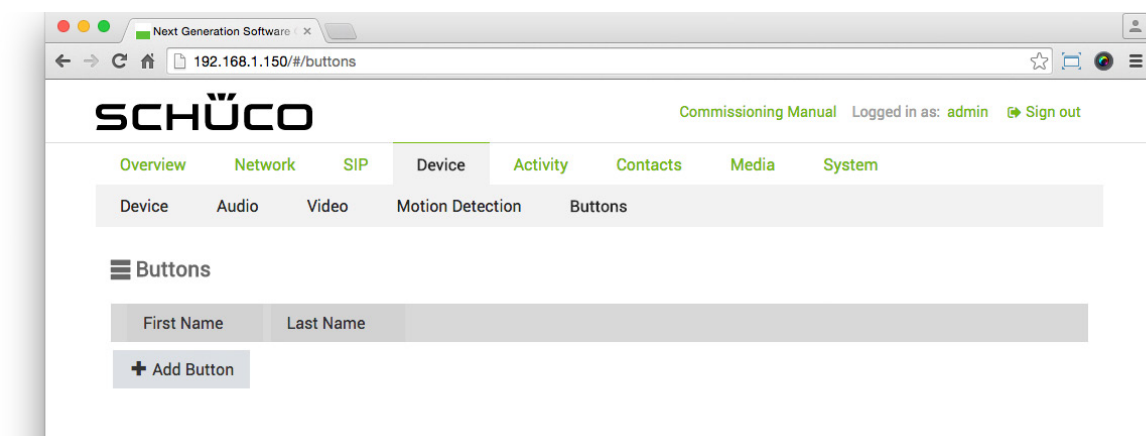

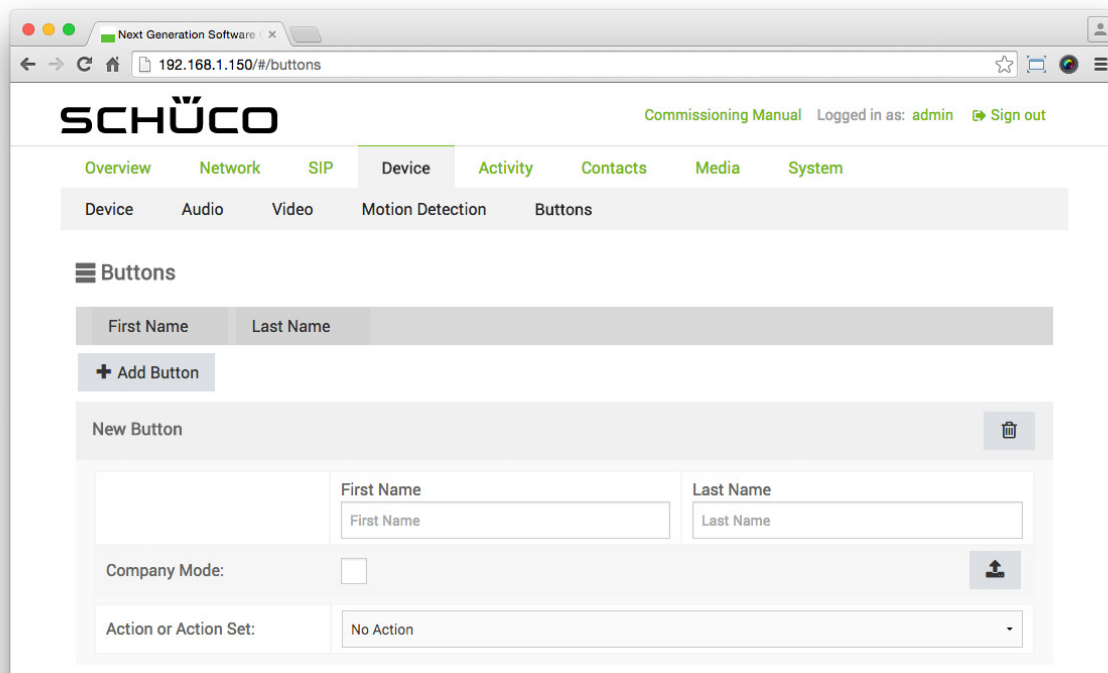

2. In the „Action or action sequence“ selection list, select the „Call“ option.

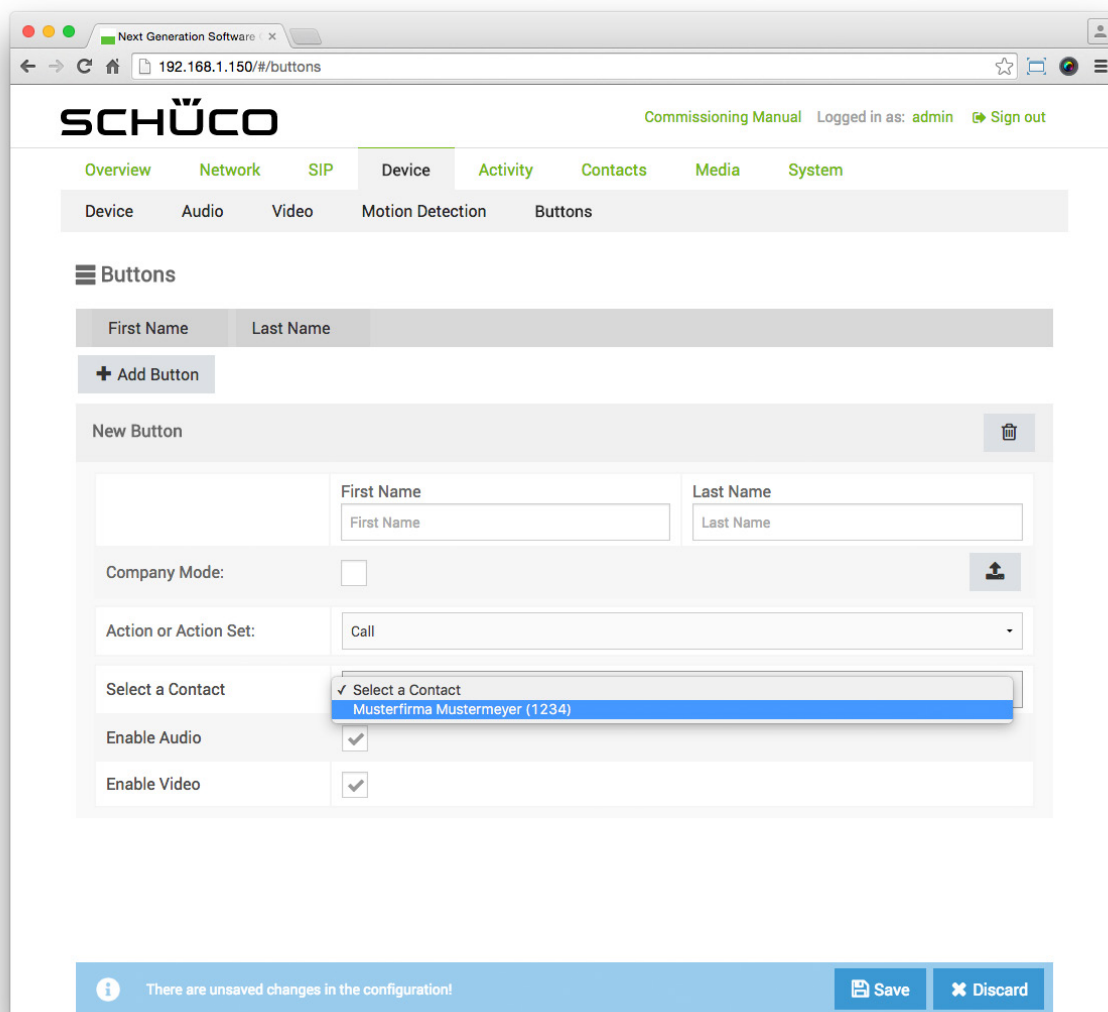

- In the „Select contacts“ selection list, select the desired contact.
The „Overwrite settings?“ dialog box appears.
- Click on „Yes“ to automatically copy over the fields „First name“ and „Surname“ as well as the profile picture of the contact

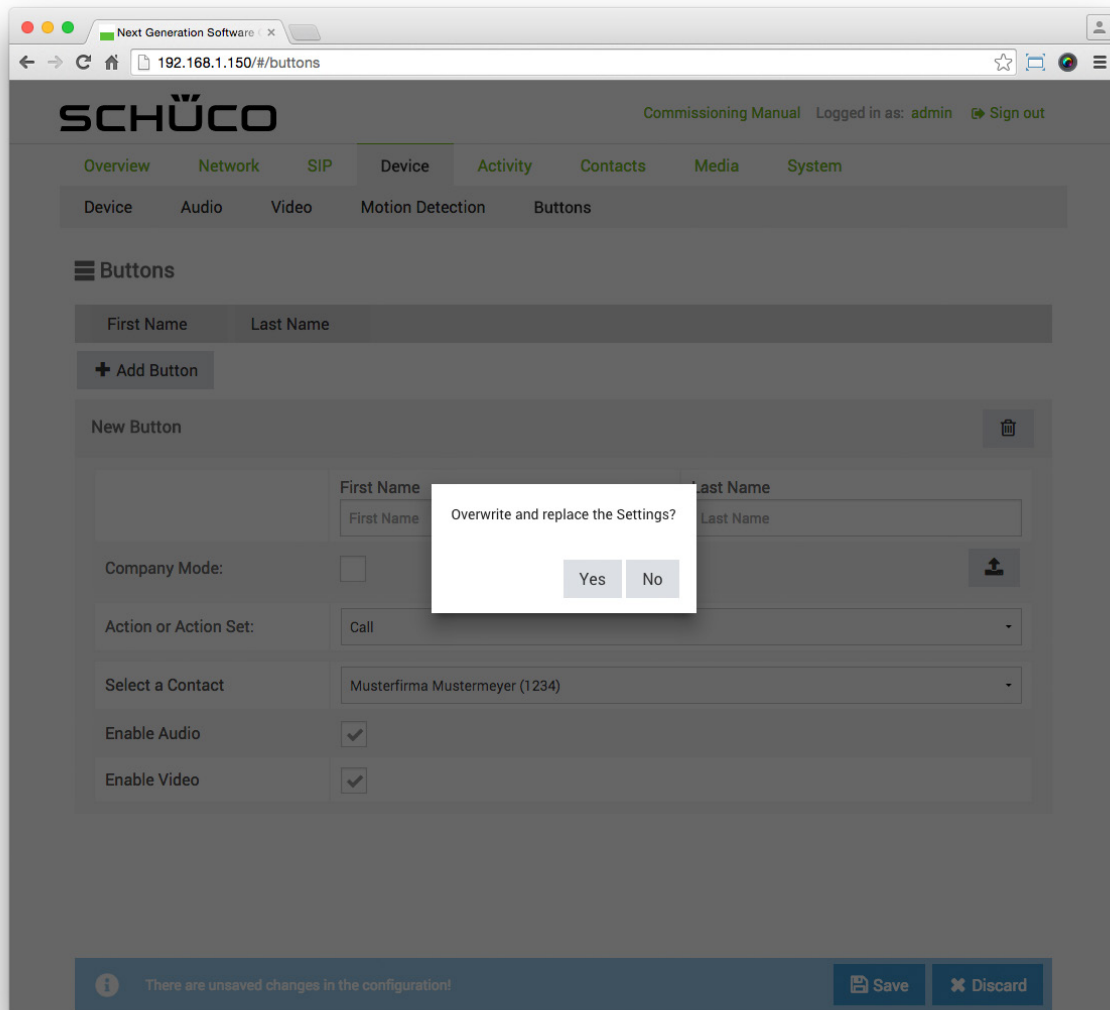

- Check the „Company mode“ checkbox.
- Check the checkboxes „Activate audio“ and „Activate video“ to enable audio and images for a call.

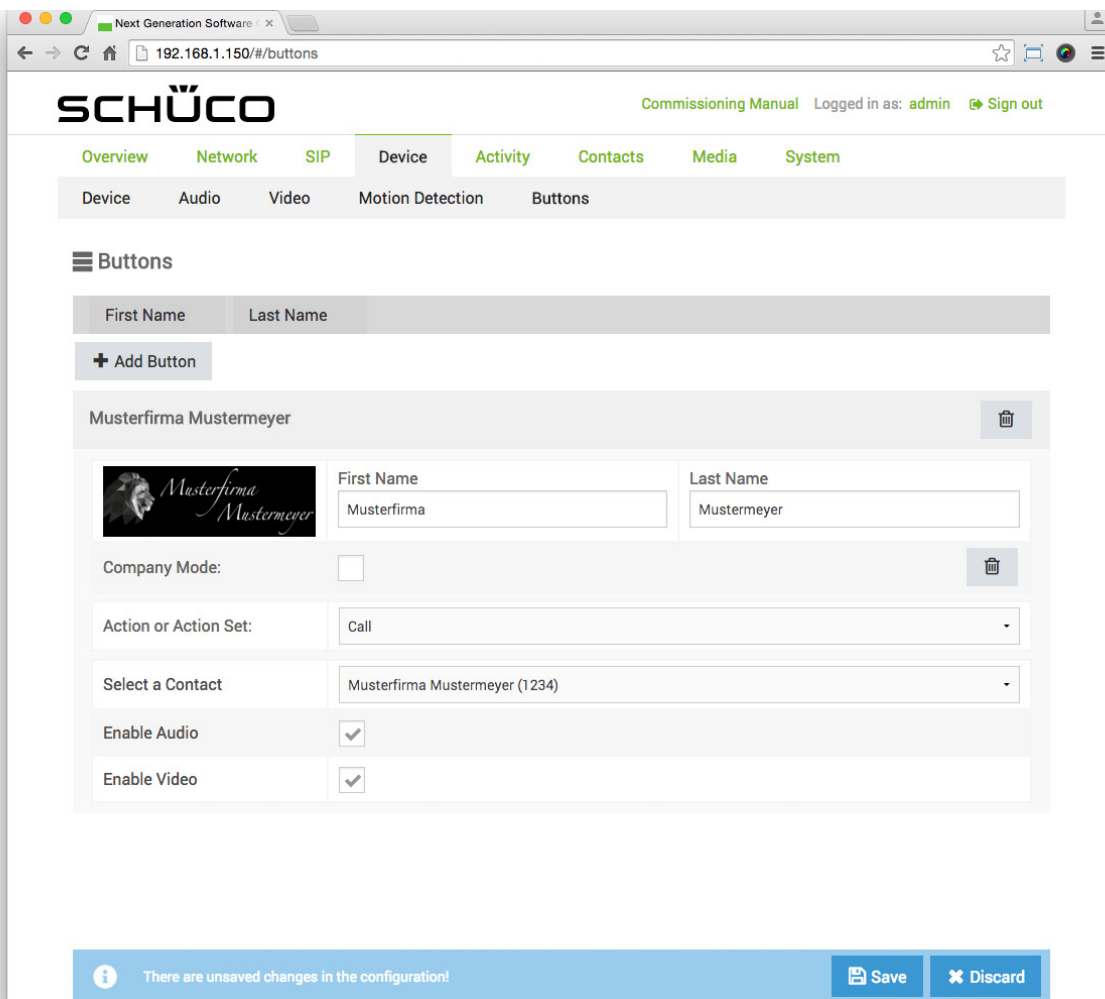

7. Click on  Save.

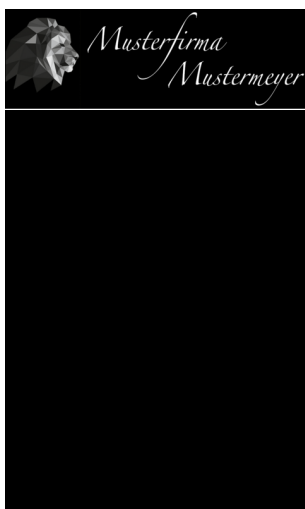

9.10. Activity

On the „Activity“ page, it is possible to configure triggers which trigger an action sequence after a certain event. As a result, the „Doorbell list“ or „Code entry“ view can be displayed automatically in the event of an input change at an input, for example.

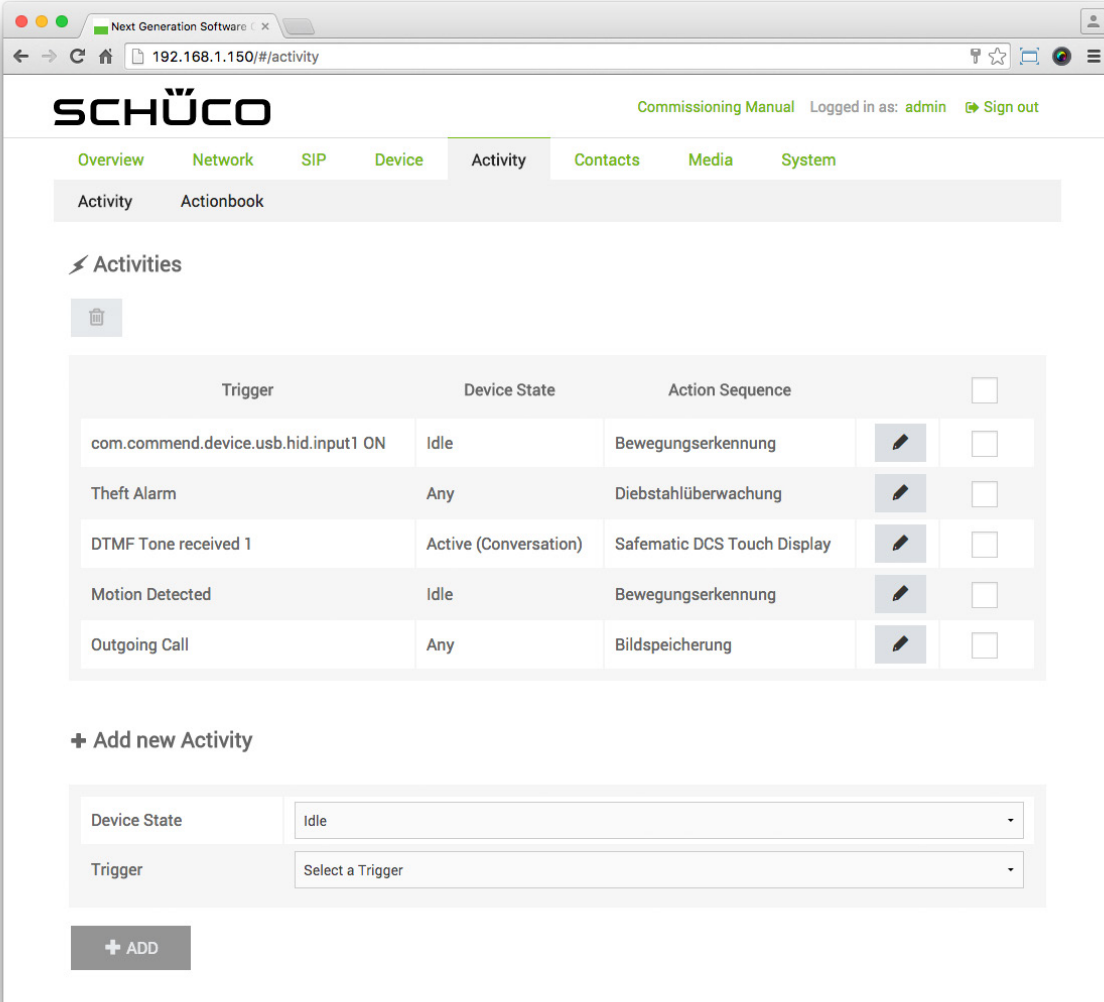

The screenshot shows the Schüco web interface for configuring activities. The browser address bar shows '192.168.1.150/#/activity'. The page title is 'SCHÜCO' and the user is logged in as 'admin'. The navigation menu includes Overview, Network, SIP, Device, Activity (selected), Contacts, Media, and System. Below the navigation, there are tabs for 'Activity' and 'Actionbook'. The main content area is titled 'Activities' and contains a table of preconfigured activities. Each activity row includes a trash icon, a checkbox, and a pencil icon for editing. Below the table is a section for adding a new activity, which includes dropdown menus for 'Device State' (set to 'Idle') and 'Trigger' (set to 'Select a Trigger'), and an '+ ADD' button.

Trigger	Device State	Action Sequence		
com.command.device.usb.hid.input1 ON	Idle	Bewegungserkennung		<input type="checkbox"/>
Theft Alarm	Any	Diebstahlüberwachung		<input type="checkbox"/>
DTMF Tone received 1	Active (Conversation)	Safematic DCS Touch Display		<input type="checkbox"/>
Motion Detected	Idle	Bewegungserkennung		<input type="checkbox"/>
Outgoing Call	Any	Bildspeicherung		<input type="checkbox"/>

+ Add new Activity

Device State:

Trigger:

+ ADD



INFORMATION

Preconfigured activities

On the „Activity“ page, there are activities which have already been preconfigured. More detailed information on these can be found under „9.14.6 Preconfigured activities“.

9.10.1. Activities

In the „Activities“ section, activities which have already been created can be edited or deleted.

The following options are available in the „Activities“ section:



: Click on this button to delete the selected activities.



: Click on this button to edit the respective activity.



: Check the checkboxes of all fields which you would like to delete.

9.10.2. Adding an activity card

In the „Activity“ section, new activities can be added.



The following options are available in the “Add activity card” section:

- Device status: Choose the status in which the DCS Touch Display is to trigger.
The following options are available for this:
 - All: The trigger is triggered in any status of the DCS Touch Display.
 - Idle: The trigger is only triggered in the “Idle” mode.
 - Select: The trigger is only triggered while the access code is being entered.
 - Ringing: The trigger is only triggered while calling.
 - Active (conversation): The trigger is only triggered during a call.
 - Error: The trigger is only triggered in the presence of a device error.
- Trigger: Select the type of event which should trigger it.
The following options are available for this:
 - Outgoing call: The trigger is only triggered by outgoing calls.
 - Error: The trigger is only triggered by a device error.
 - Input change: The trigger is only triggered by an input change (inputs of the DCS Touch Display and, if present, IP secure connector).
 - DTMF tone received: The trigger is only triggered when a DTMF tone is received (“0” to “9”, “A” to “D”, “*” or “#”).
 - Incoming call: The trigger is only triggered by incoming calls from all or only certain contacts.
-  : Click on this button to add an activity card.

9.10.3. Editing an activity

As soon as you have clicked on  for an activity, you can edit it.

The following options are available under “Edit activity”:

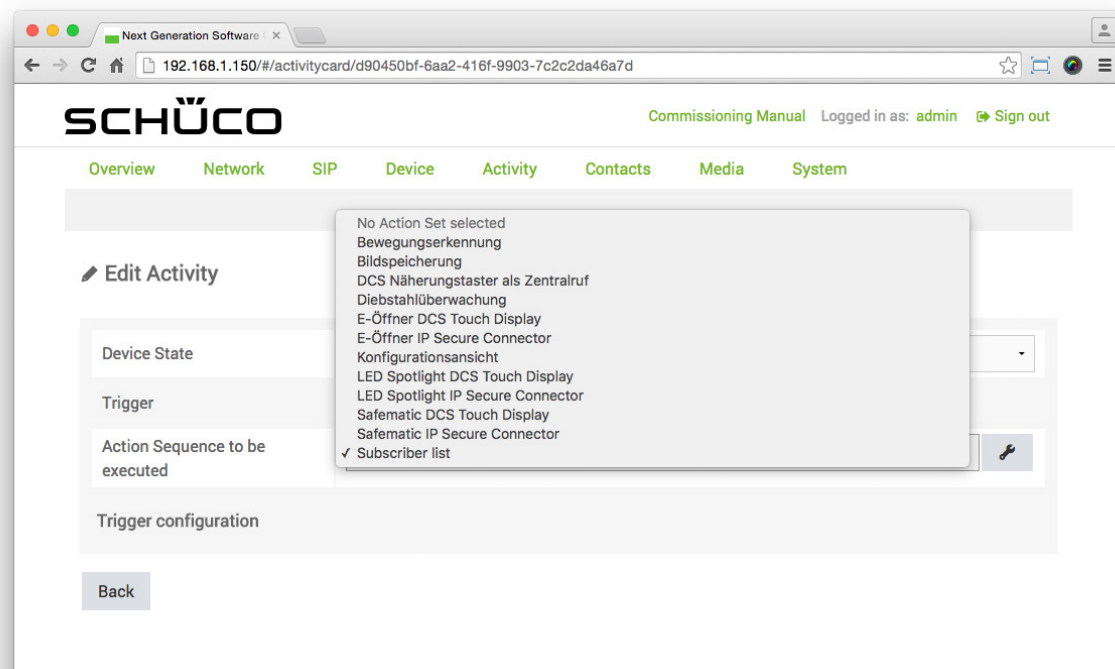

- **Device status:** Choose the status in which the DCS Touch Display is to trigger. The following options are available for this:
 - All: The trigger is triggered in any device status of the DCS Touch Display.
 - Idle: The trigger is only triggered in the “Idle” device status.
 - Select: The trigger is only triggered while an outgoing call is being initiated.
 - Ringing: The trigger is only triggered while an incoming call is ringing.
 - Active (conversation): The trigger is only triggered during a conversation.
 - Error: The trigger is only triggered in the presence of a device error.
- **Trigger:** This shows which is the trigger in question.
- **Implementing action sequence:** Select a previously created action sequence in this selection list.
 -  : Click on this button to create a new action sequence on the “Action sequences” page. It is possible to select this action sequence immediately in the “Implementing action sequence” selection list. However, it must be configured on the “Action sequences” page before it can be used.
 -  : If an action sequence has already been stored for this activity, click on this button to edit the action sequence. Where an action sequence has been stored, this button is shown instead of .
- **Button:** Select the button which is to trigger it (button in the “Doorbell list” view).







9.10.4. Creating an activity

The following example will help to explain how an activity is created on the “Activity” page. The aim here is to display the “Doorbell list” view when the integrated camera of the DCS Touch Display detects a movement in the “Idle” device status.

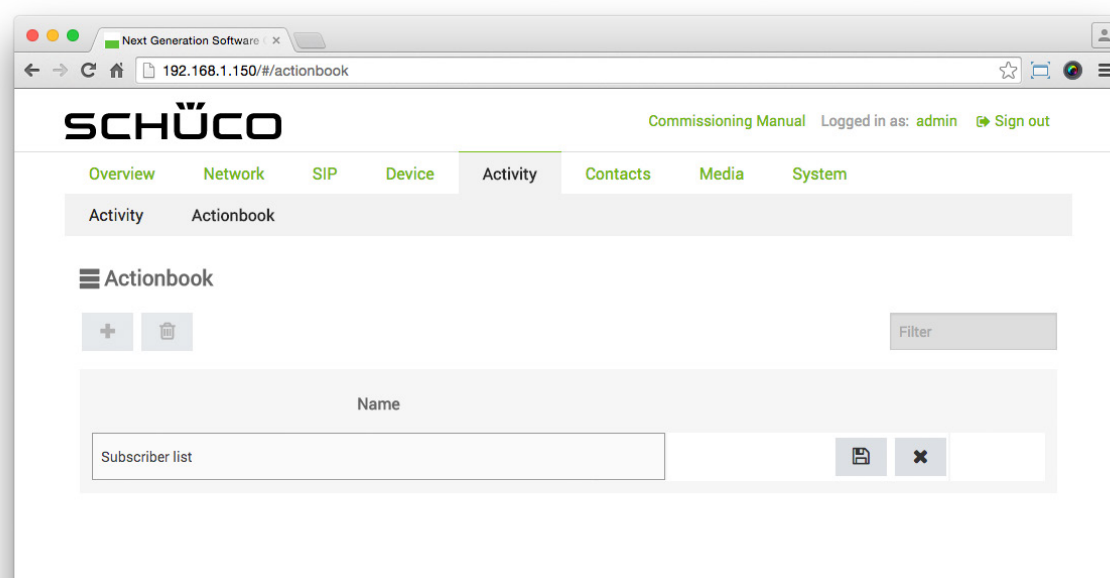
To create an action sequence to display the “Doorbell list” view and then an activity as a trigger, proceed as follows:

1. Open the “Action sequences” page via “Activity”.
2. Click on .
3. Enter a meaningful term or phrase for the action sequence in the “Name” field (e.g. “Doorbell list”).
4. Click on .

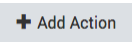

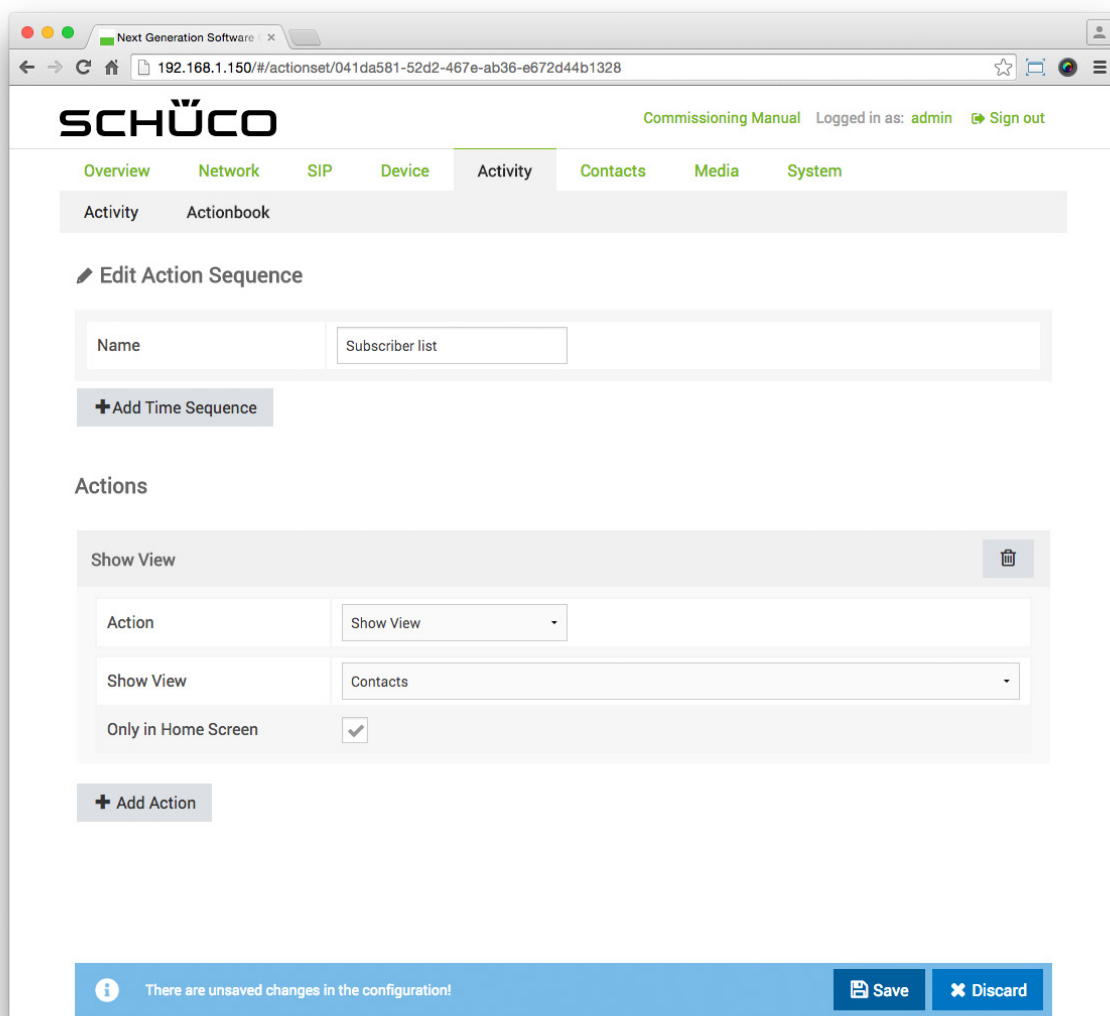

5. Click on .
6. Click on .
7. In the “Action” selection list, select the “Show view” option.
8. In the “Show view” selection list, select the “Contacts” option.
9. Check the “Only in idle mode” checkbox.
10. Click on .

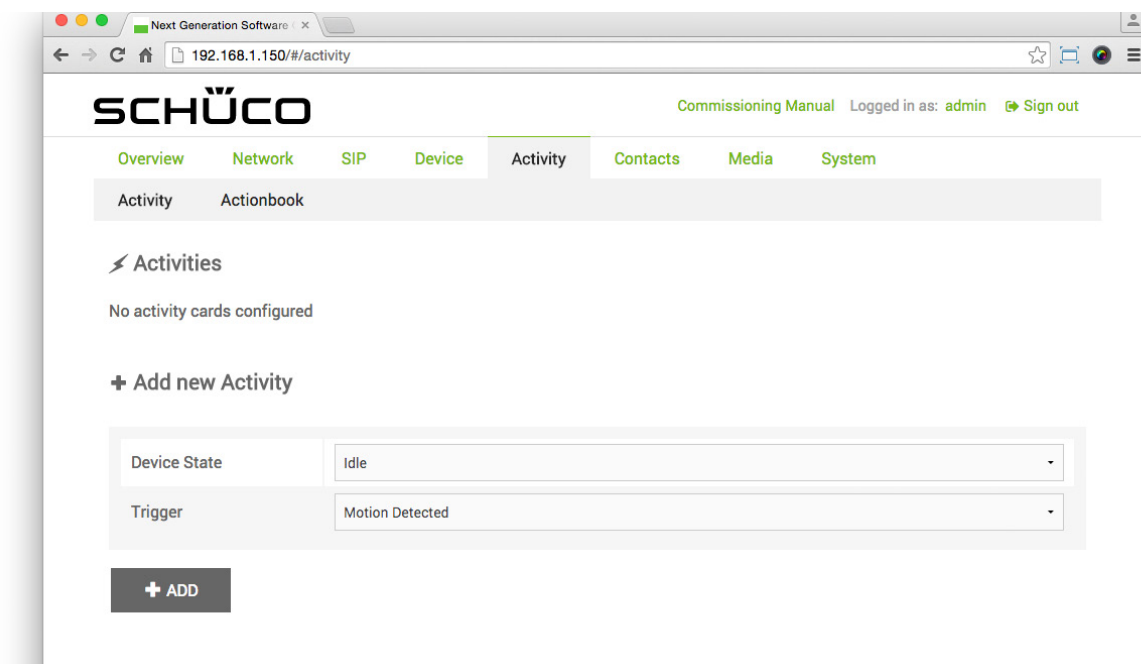

11. Open the “Activity” page via “Activity”.
12. In the “Device status” selection list, select the “Idle” option.
13. In the “Trigger” selection list, select the “Motion detection” option.
14. Click on .



15. Click on .
16. Click on .
17. In the “Implementing action sequence” selection list, select the action sequence previously created (e.g. “Doorbell list”).
18. Click on .

Next Generation Software x

192.168.1.150/#/activitycard/b02789a1-25a7-4350-8133-60fd9c63d5b6

SCHÜCO Commissioning Manual Logged in as: admin Sign out

Overview Network SIP Device Activity Contacts Media System

Edit Activity

Device State Idle

Trigger Motion Detected

Action Sequence to be executed Subscriber list

Trigger configuration

Back

There are unsaved changes in the configuration! Save Discard



INFORMATION

Motion detection settings

More detailed information about the configuration of motion detection can be found under „9.11 Motion detection“.

9.10.5. Preconfigured activities.

The following activities are preconfigured in the factory and may be adopted, changed or deleted as required:

- **DCS Touch Display - IN 1 one:** If a DCS proximity switch is provided for installation, the “Motion detection” action sequence is triggered via this activity so that the “Doorbell list” view is displayed in the event of an input change (see also “9.15.6 Preconfigured action sequences”).
The activity is configured as follows as standard:
 - Device status: Idle
 - Implementing action sequence: DCS proximity switch
 - Input: DCS Touch Display - IN
 - Input value: One
- **Anti-theft alarm:** If the anti-theft device for the DCS Touch Display is to be activated, the “Anti-theft monitoring” action sequence is triggered via this activity so that the “Alarm on” symbol is displayed and the “Alarm.wav” audio file is played (see also “9.15.6 Preconfigured action sequences”).
The activity is configured as follows as standard:
 - Device status: All
 - Implementing action sequence: Anti-theft monitoring
- **DTMF tone received 1:** If a SafeMatic is provided for installation, the “Safematic DCS Touch Display” action sequence is triggered via this activity so that the door opener is actuated when the DTMF tone “1” is received (see also “9.15.6 Preconfigured action sequence”).
The activity is configured as follows as standard:
 - Device status: Active (conversation)
 - Implementing action sequence: SafeMatic DCS Touch Display
 - DTMF tone: 1
- **Motion detection:** If movement has been detected by the motion detection function in the integrated camera, the “Motion detection” action sequence is triggered via this activity and the “Doorbell list” view is displayed (see also “9.15.6 Preconfigured action sequence”).
 - Device status: Idle
 - Implementing action sequence: Motion detection
- **Outgoing call:** If a call is triggered on the DCS Touch Display, the “Image storage” action sequence is triggered via this activity and a snapshot is taken (see also “9.15.6 Preconfigured action sequence”). This snapshot can be downloaded on the “Photos” page or deleted (see also “9.17.2 Photos”).
 - Device status: All
 - Implementing action sequence: Image storage



INFORMATION

Privacy

The image rights belong to the person who was photographed.

9.11. Action sequences

On the “Action sequence” page, it is possible to configure logical command sequences which can be triggered through specific activities or the entry of the access code. As a result, it is possible, for example, to display the “Configuration” view after the access code is entered, to call up the “Doorbell list” view when movement is detected (see “9.13.4 Creating an activity”) or to play an audio file after tapping a contact in the “Doorbell list” view.





The screenshot shows a web browser window with the URL `192.168.1.150/#/actionbook`. The page header includes the Schüco logo, a "Commissioning Manual" link, and the user "admin" is logged in. The navigation menu includes "Overview", "Network", "SIP", "Device", "Activity", "Contacts", "Media", and "System". The "Activity" sub-menu is active, showing "Activity" and "Actionbook".

The "Actionbook" section contains a list of activities. Each activity has a name, a pencil icon for editing, and a checkbox for selection. The activities listed are:

Name		
Bewegungserkennung		<input type="checkbox"/>
Bildspeicherung		<input type="checkbox"/>
DCS Näherungstaster als Zentralruf		<input type="checkbox"/>
Diebstahlüberwachung		<input type="checkbox"/>
E-Öffner DCS Touch Display		<input type="checkbox"/>
E-Öffner IP Secure Connector		<input type="checkbox"/>
Konfigurationsansicht		<input type="checkbox"/>
LED Spotlight DCS Touch Display		<input type="checkbox"/>
LED Spotlight IP Secure Connector		<input type="checkbox"/>
Safematic DCS Touch Display		<input type="checkbox"/>
Safematic IP Secure Connector		<input type="checkbox"/>

9.11.1. Action sequences



In the “Action sequences” section, action sequences can be created, edited and deleted.

-  : Click on this button to add an action sequence.
-  : Click on this button to delete one or more selected action sequences.
-  : Click on this button to edit the corresponding action sequence (the “Edit action sequence” section appears).
-  : Check the checkboxes of all action sequences which you would like to delete.
- : Enter a search term in this field and press the “Enter” button to search for an action sequence that has already been created.

9.11.2. Editing action sequences

In the “Editing action sequences” section, action sequences can be edited.

The following options are available in the “Editing action sequences” section:

- Name: Enter a meaningful name for the action sequence.
-  Add Time Sequence : Click on this button to add a time sequence.
-  : Click on this button to delete the time sequence.



INFORMATION

Time sequences

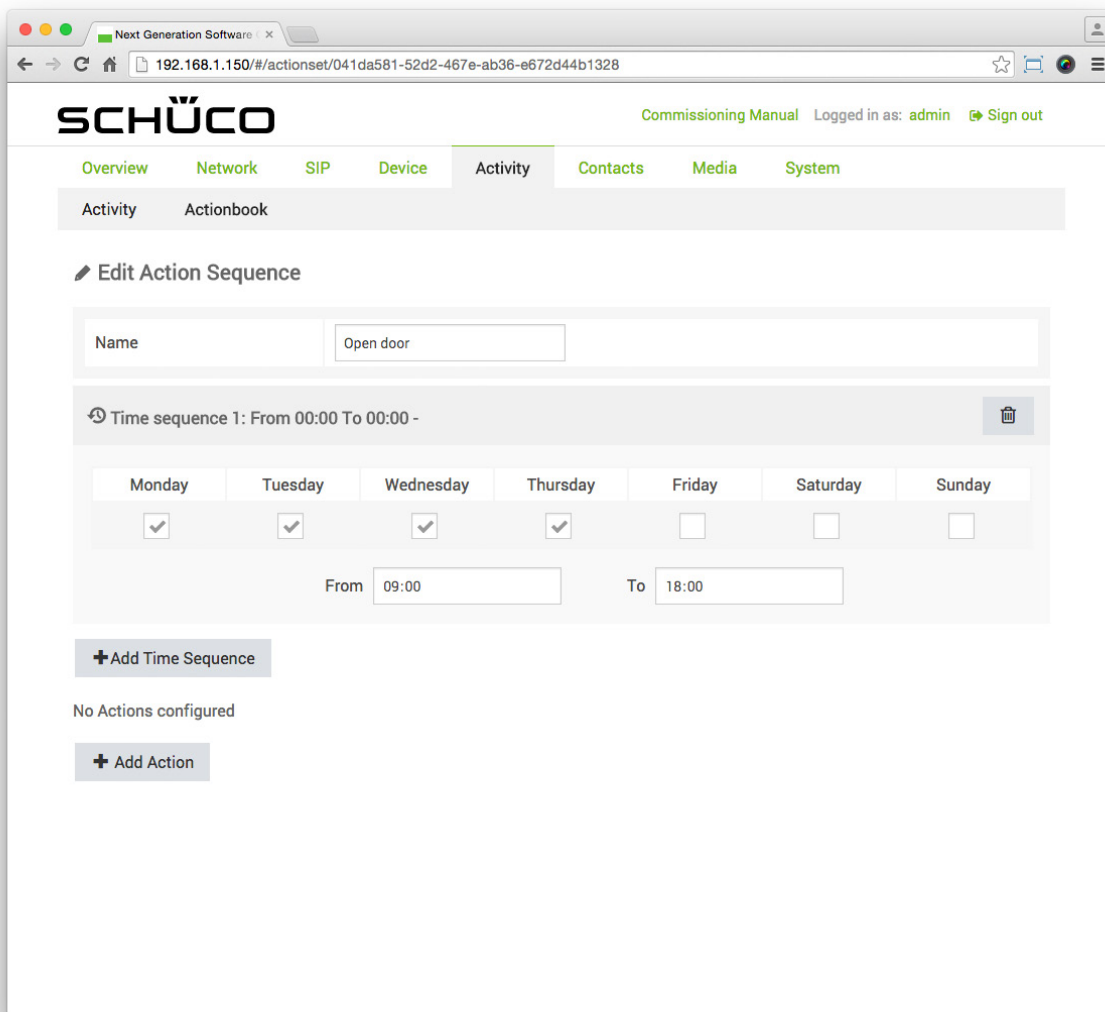

Multiple time sequences can be created in order to stop the action sequence being performed during lunch breaks, for example. For days within one week which are to have different time sequences (e.g. „Monday 10:00 until 16:00 and Tuesday 09:00 until 17:00“), multiple time sequences must be created.



9.11.3. Actions

In the “Actions” section, actions for action sequences can be defined.

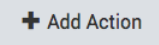
The following options are available in the “Actions” section:

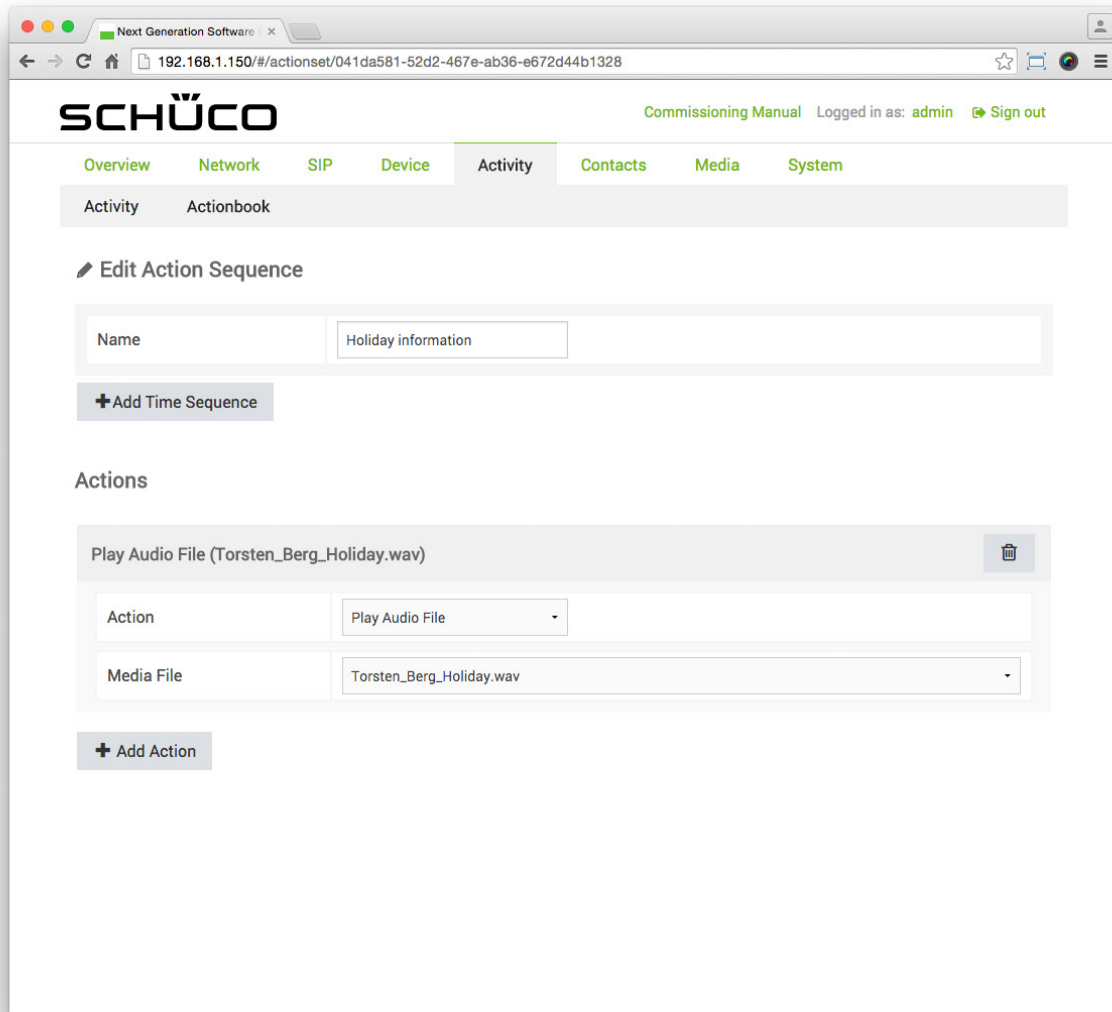

- Action: Select the desired action or action sequence. The following options are available for this:
 - Play audio file: Here an audio file is played which has already been uploaded via the “Media” page.
 - Output: Here an output (relay) on the DCS Touch Display (“DCS Touch Display - OUT 1” or “DCS Touch Display - DC-OUT 2”) or IP secure connector (“IP secure connector - OUT 1”, “IP secure connector - OUT 2” or “IP secure connector - DC-OUT 3”) is switched.
 - Send e-mail: Here an e-mail is sent from the contact which was configured on the “System” page.
 - End conversation: Here the current call is ended.
 - Logout: Here the user currently logged in is logged out.
 - Mute microphone: Here the microphone signal is muted.
 - Call: Here a call is initiated to a contact which has already been created on the “Contacts” page.
 - Accept call: Here an incoming call is answered.
 - Snapshot: Here a picture is taken using the built-in camera. This can be displayed on the “Media” page.
 - Send DTMF tone: Here a DTMF tone is sent to an SIP-compatible intercom station or an SIP telephone.
 - Play location report to counterpart intercom station: This option currently has no function.
 - Delayed action: Here a specific action sequence is only started after a defined period of time has elapsed.
 - Switch video: This option currently has no function.
 - Show view: Here the screen of the DCS Touch Display switches to a configurable view.
 - Show symbol: Here a configurable symbol is shown on the screen of the DCS Touch Display.
-  : Click on this button to add a further action.
-  : Click on this button to delete the action.







9.11.4. Creating an action sequence

The following example will help to explain how an action sequence is created on the “Action sequences” page. The aim here is to configure a door opener in order to be able to actuate it after the access code is entered in the “Code entry” view.

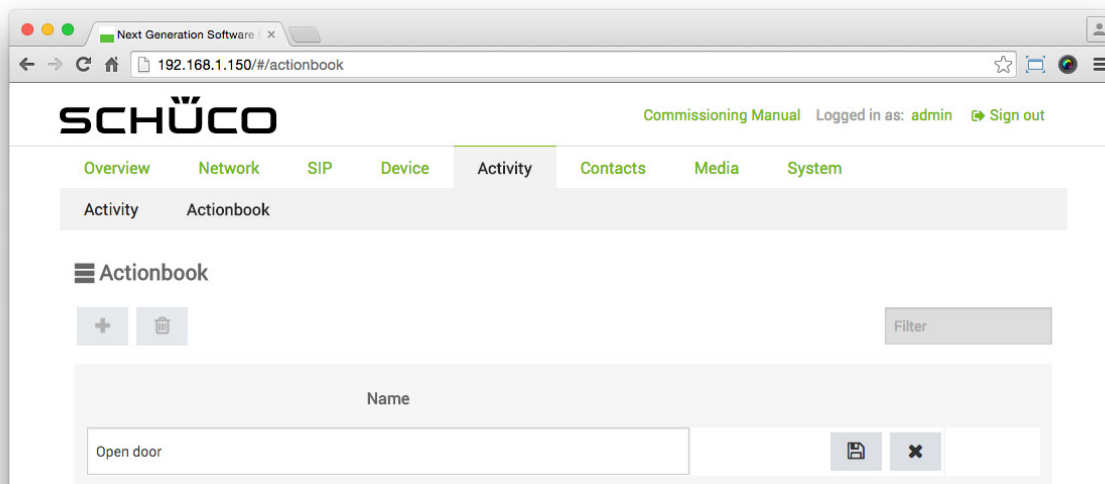
To create an action sequence for a door opener, proceed as follows:

1. Open the “Action sequences” page via “Activity”.
2. Click on .
3. Enter a meaningful term or phrase for the action sequence in the “Name” field (e.g. “Open door”).
4. Click on .



5. Click on .
6. Click on  Add Action.
7. In the “Action” selection list, select the “Output” option.
8. In the “Output” selection list, select the output to which the door opener is connected (e.g. “Output 1”).
9. In the “Value” selection list, select the “On-off sequence” option.
10. In the field “Duration [s]”, enter the time in seconds for which the door opener is to be actuated (e.g. “3”).
11. Click on .
12. Via “System”, open the “User administration” page.
13. Under the user “admin”, click on .

14. Check the checkbox of the action sequence just created under the “Permitted action sequences” section (e.g. “Open door”).

15. Click on .

9.11.5. Anti-theft sequence

The following example will help to explain how you create an action sequence which is triggered as soon as the DCS Touch Display switches to alarm mode. The aim here is to produce a snapshot and send an e-mail with the notification “I am being stolen” to two recipients.

To create an action sequence for an anti-theft sequence, proceed as follows:

1. Open the “Action sequences” page via “Activity”.

2. Click on .

3. Enter a meaningful term or phrase for the action sequence in the “Name” field (e.g. “Anti-theft sequence”).

4. Click on .

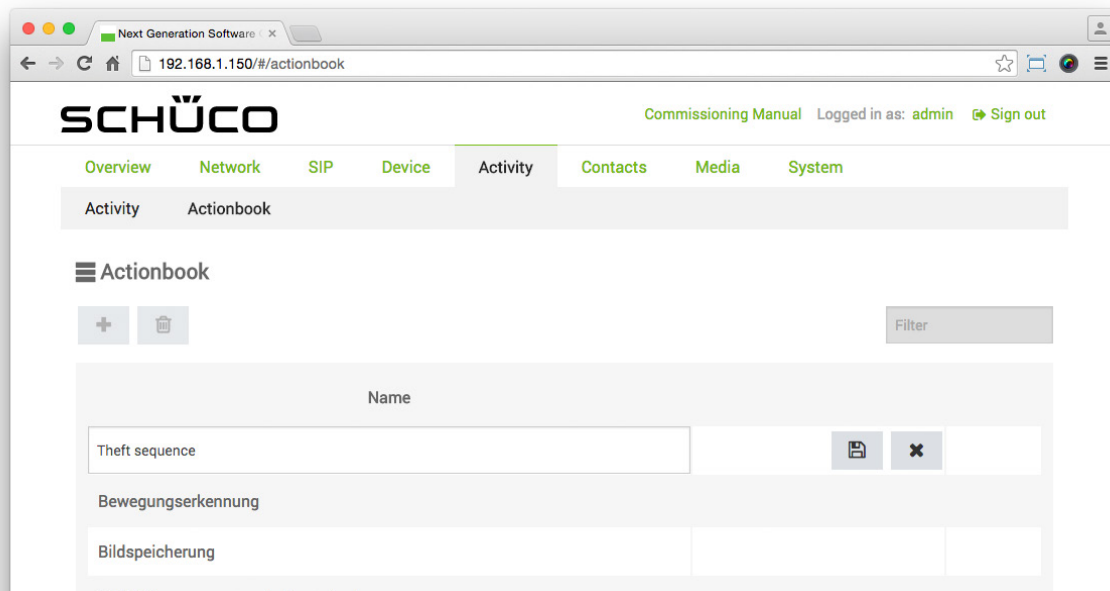



5. Click on .

6. Click on .

7. In the “Action” selection list, select the “Snapshot” option.

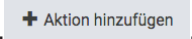
8. Click on .

9. In the “Action” selection list, select the “Send e-mail” option.
10. Enter the recipient’s e-mail address in the “Recipient” field.
11. Enter a meaningful subject in the “Subject” field (e.g. “I am being stolen”).
12. Enter meaningful text in the “Contents” field (e.g. “At this moment your DCS Touch Display is being removed without permission.”).
13. Click on  .
14. Repeat steps “10.” to “12.” for this action.
15. Click on  .

Next Generation Software x

192.168.1.150/#/actionset/ef7a1108-c6b9-42d0-87b2-ce0d5b7a292a

SCHÜCO Commissioning Manual Logged in as: admin Sign out

Overview Network SIP Device **Activity** Contacts Media System

Activity Actionbook

Edit Action Sequence

Name Theft sequence

+ Add Time Sequence

Actions

Snapshot

Action Snapshot

Send Email

Action Send Email

Receiver torsten_berg@mail.com

Subject Your DCS Touch Display is stolen!

Content In this moment, your DCS Touch Display is removed without permission.

Send Email

Action Send Email

Receiver philipp_schuhmacher@mail.com

Subject Your DCS Touch Display is stolen!

Content In this moment, your DCS Touch Display is removed without permission.

+ Add Action

There are unsaved changes in the configuration!

Save Discard

16. Open the “Activity” page via “Activity”.
17. In the “Device status” selection list, select the “All” option.
18. In the “Trigger” selection list, select the “Anti-theft alarm” option.

19. Click on .

20. Click on .

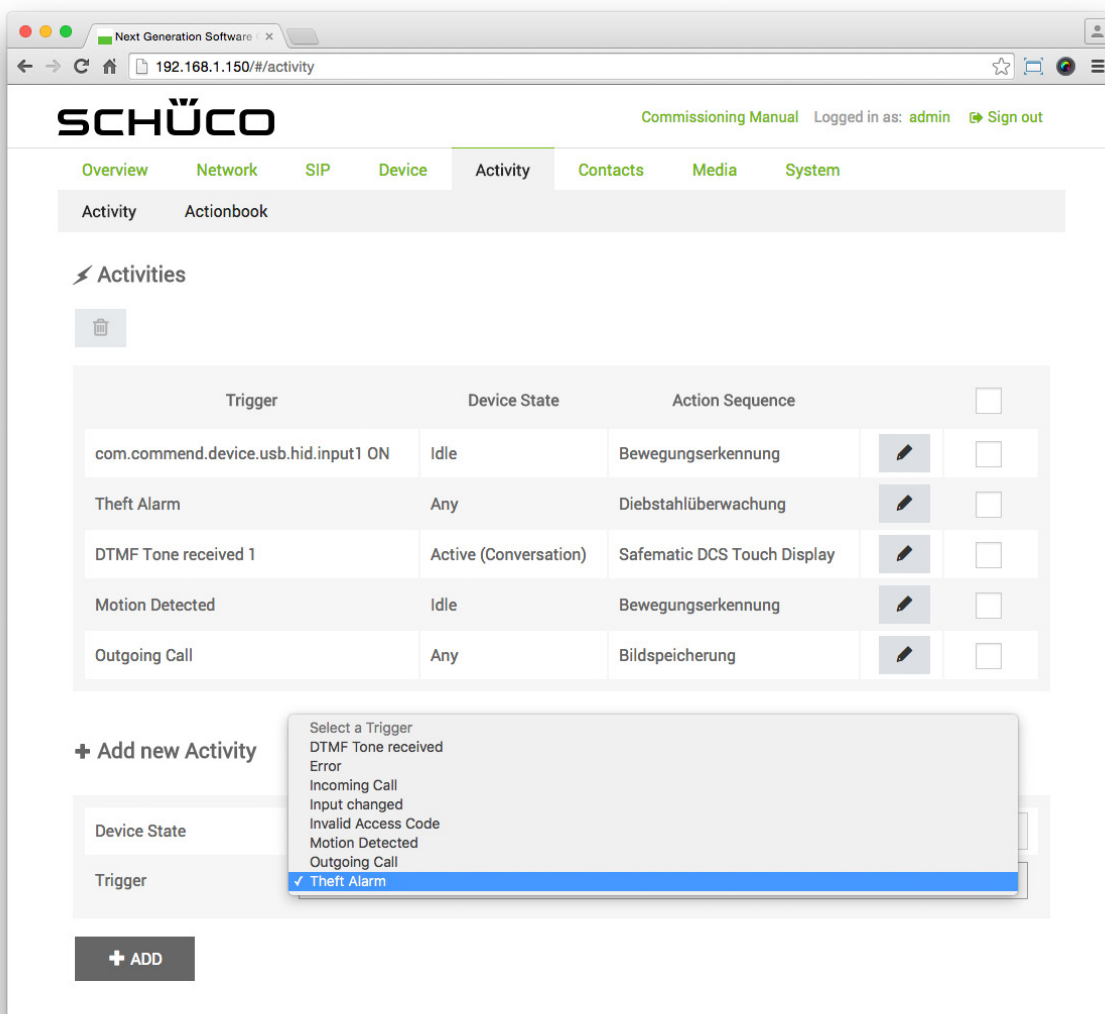

21. Click on . In the selection list, select the action sequence just created (e.g. “Anti-theft sequence”).

22. Click on .

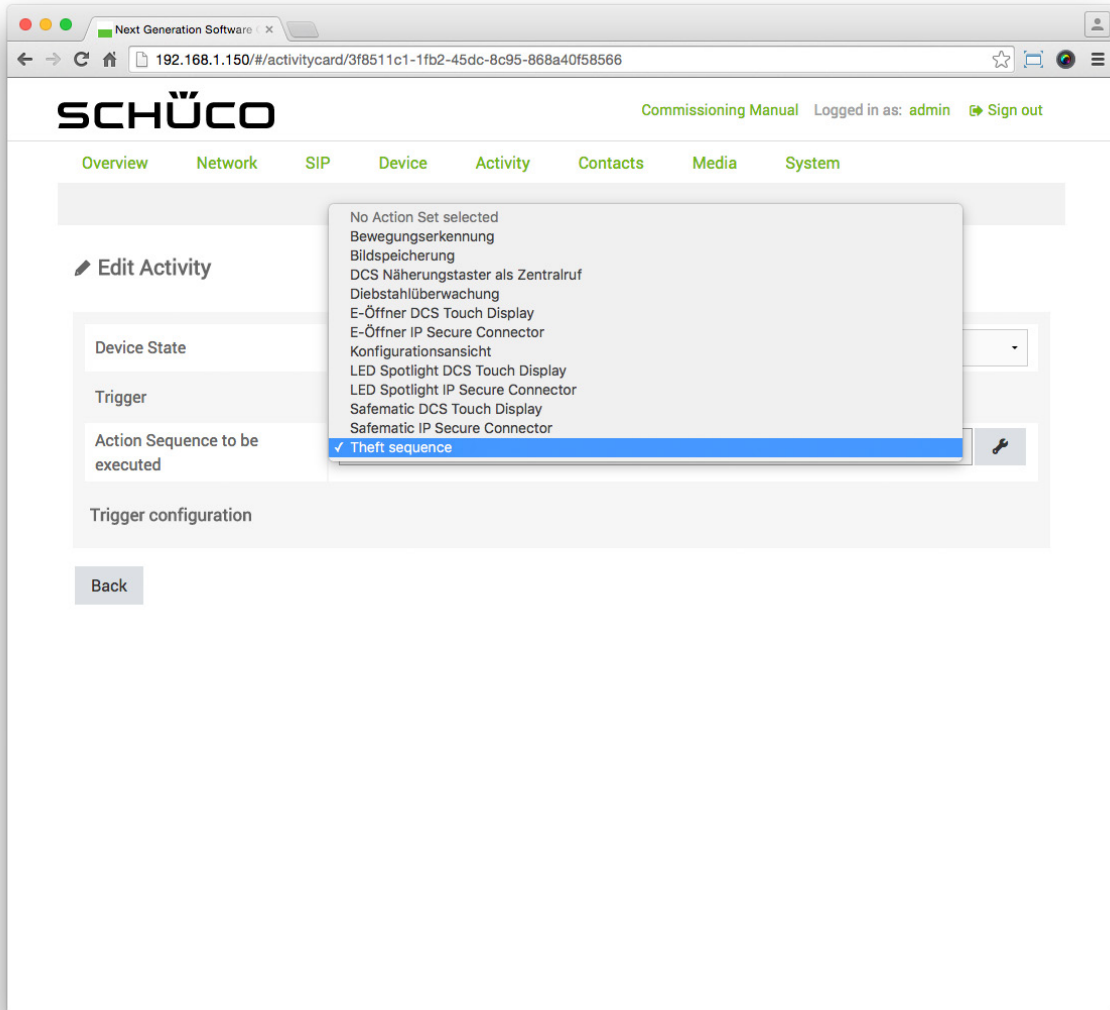

9.11.6. Preconfigured action sequences

The following activities are preconfigured in the factory and may be adopted, changed or deleted as required:

- **Motion detection:** Provided that buttons have been configured (see 7.9 “Buttons”), the “Contacts” view is displayed via this action sequence for the “Motion detection” activity (see “7.10.5 Preconfigured activities”).
The configuration is configured as follows as standard:
 - “Show view” action
 - Action: Show view
 - Show view: Contacts
 - Only in idle mode: Checkbox checked
- **Image storage:** As soon as a call is triggered on the DCS Touch Display, the internal camera takes a snapshot (see “7.10.5 Preconfigured activities”). This snapshot can be downloaded on the “Photos” page or deleted (see “7.14 Photos”).
The configuration is configured as follows as standard:
 - “Show view” action
 - Action: Snapshot
- **DCS proximity switch as a central phone number:** If a DCS proximity switch is provided for installation, a call to the preconfigured contact “Contact example 1” is made by means of this action sequence. The aim is to install the DCS proximity switch in such a way that, in terms of ease of access, a call is automatically triggered as soon as a wheelchair user is in front of the DCS Touch Display, for example. The action sequence is configured as follows as standard:
 - “Call (contact example 1)” action:
 - Action: Call
 - Select contact: Contact example 1 (1234@example.com)
 - Activate audio: Checkbox checked
 - Activate video: Checkbox checked
- **Anti-theft monitoring:** Via this action sequence, an activated anti-theft device means that the “Alarm on” symbol is displayed and the “Alarm.wav” audio file is played (see “7.7.4 Creating an activity” and “7.5.2 Anti-theft device”).
The action sequence is configured as follows as standard:
 - “Show symbol” action
 - Action: Show symbol
 - Symbol: “Alarm on”
 - Duration [ms]: 10,000
 - “Play audio file (Alarm.wav)” action
 - Action: Play audio file
 - Media file: “Alarm.wav”
- **Electric strike for DCS Touch Display:** If an electric strike is provided for installation, the output “DCS Touch Display - OUT 1” is switched via this action sequence and the “Door” symbol is shown for 4 seconds. The action sequence is configured as follows as standard:
 - “Toggle DCS Touch Display - OUT 1 off sequence” action:
 - Action: Output
 - Output: DCS Touch Display - OUT 1
 - Value: On-off sequence
 - Duration [s]: 4
 - “Show symbol” action:
 - Action: Show symbol
 - Symbol: “Door”
 - Duration [ms]: 4000
 - “Delayed action” action:
 - Action: End call
 - Delay [ms]: 1000







- Electric strike for IP secure connector: If an electric strike is provided for installation, the output “IP secure connector - OUT 3” is switched via this action sequence and the “Door” symbol is shown for 4 seconds. The action sequence is configured as follows as standard:
 - “Toggle IP secure connector - OUT 3 on-off sequence” action:
 - Action: Output
 - Output: IP secure connector - OUT 3
 - Value: On-off sequence
 - Duration [s]: 4
 - “Show symbol” action:
 - Action: Show symbol
 - Symbol: “Door”
 - Duration [ms]: 4000
 - “Delayed action” action:
 - Action: End call
 - Delay [ms]: 1000
- Configuration view: Via this action sequence it is possible to call up the “Configuration” view after entering the access code in the “Code entry” view.
The action sequence is configured as follows as standard:
 - “Show view” action
 - Action: Show view
 - Show view: Configuration
 - Only in idle mode: Checkbox deactivated
- LED spotlight for DCS Touch Display: If an LED spotlight is provided for installation, the output “DCS Touch Display - OUT 1” is switched via this action sequence.
The action sequence is configured as follows as standard:
 - “Toggle DCS Touch Display - OUT 1 on-off sequence” action:
 - Action: Output
 - Output: DCS Touch Display - OUT 1
 - Value: Toggle
- LED spotlight for IP secure connector: If an LED spotlight is provided for installation, the output “IP secure connector - OUT 2” is switched via this action sequence.
The action sequence is configured as follows as standard:
 - “Toggle IP secure connector - OUT 2 on-off sequence” action:
 - Action: Output
 - Output: IP secure connector - OUT 2
 - Value: Toggle
- SafeMatic for DCS Touch Display: If a SafeMatic is provided for installation, the output “DCS Touch Display - OUT 1” is switched via this action sequence with the aid of the activity “DTMF tone received 1” and the “Door” symbol is shown for 4 seconds (see also “7.7.4 Creating an activity”).
The action sequence is configured as follows as standard:
 - “Toggle DCS Touch Display - OUT 1 on-off sequence” action:
 - Action: Output
 - Output: DCS Touch Display - OUT 1
 - Value: On-off sequence
 - Duration [s]: 4
 - “Show symbol” action:
 - Action: Show symbol
 - Symbol: “Door”
 - Duration [ms]: 4000
 - “Delayed action” action:
 - Action: End call
 - Delay [ms]: 1000

- SafeMatic for IP secure connector: If a SafeMatic is provided for installation, the output “IP secure connector - OUT 3” is switched via this action sequence with the aid of the activity “DTMF tone received 1” and the “Door” symbol is shown for 4 seconds (see also “7.7.4 Creating an activity”). The action sequence is configured as follows as standard:
 - “Toggle IP secure connector - OUT 3 on-off sequence” action:
 - Action: Output
 - Output: IP secure connector - OUT 3
 - Value: On-off sequence
 - Duration [s]: 20
 - “Delayed action” action
 - Action: Delayed action
 - Action: Output
 - Delay [ms]: 1000
 - Output: IP secure connector - OUT 3
 - Value: On-off sequence
 - Value [s]: 4
- “Show symbol” action:
 - Action: Show symbol
 - Symbol: “Door”
 - Duration [ms]: 4000
 - “Delayed action” action:
 - Action: End call
 - Delay [ms]: 1000

9.12. Contacts

On the “Contacts” page, it is possible to create, edit and delete contacts. These can be both displayed in the “Doorbell list” view (see “7.6.1 Adding a new contact to the doorbell list”) and used as users for the web interface or entry of the access code (see “7.12.5 Changing a password”).

The following options are available in the “Contacts” section:

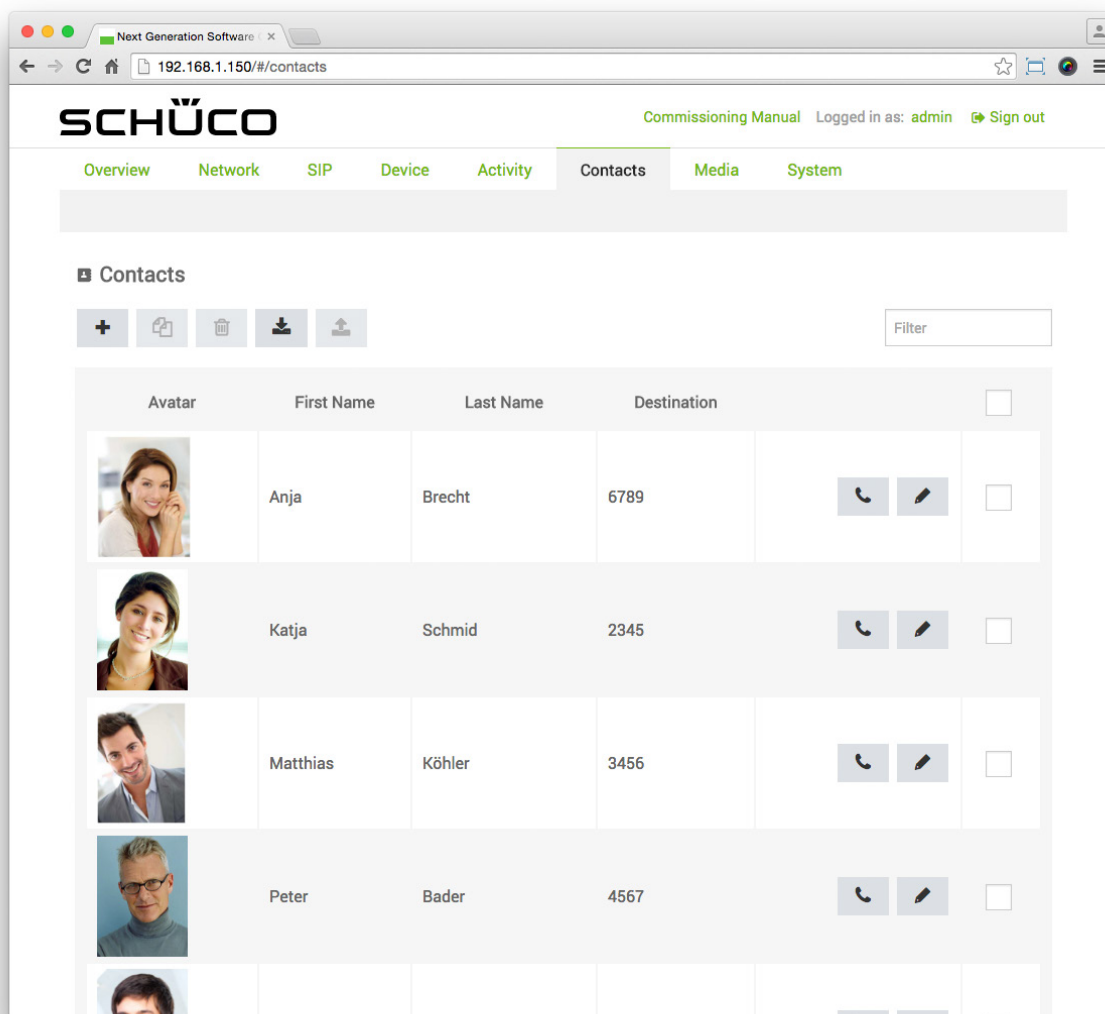

-  : Click on this button to add a new contact.
-  : Click on this button to copy one or more contacts (to do so, the corresponding contacts must be selected).
-  : Click on this button to delete one or more contacts (to do so, the corresponding contacts must be selected).
-  : Click on this button to import one or more contacts (XLSX file; text only, no images).
-  : Click on this button to export one or more contacts (to do so, the corresponding contacts must be selected).
-  : Click on this button to initiate a call to the contact already created.
-  : Click on this button to edit a contact that has already been created.
- : Check the checkboxes of all contacts which you would like to copy, delete or export.
- : Enter a search term in this field and press the “Enter” button to search for a contact that has already been created.



9.12.1. Editing a contact

As soon as you have clicked on  next to a contact, you can edit it.

The following options are available for this:

- Profile picture: Check whether the correct profile picture for the contact has been uploaded.
- First name: Enter the first name of this contact.
- Surname: Enter the surname of this contact. Destination: Enter the SIP telephone number of this contact.
-  : Upload a profile picture for this contact.
-  : Delete this contact.
-  : Save the changes for this contact.

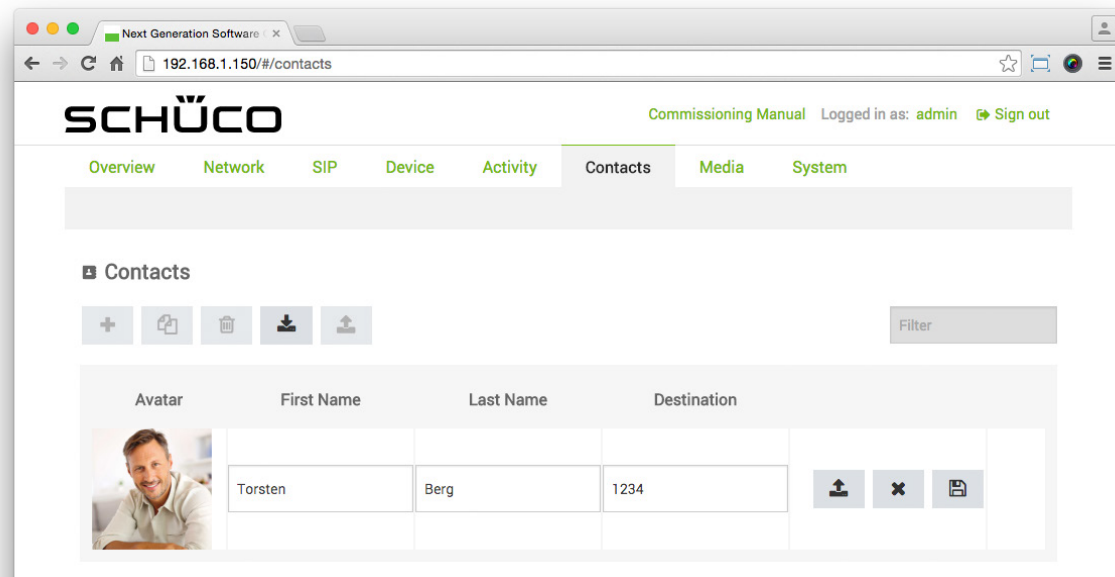

9.12.2. Adding a contact

The following example will help to explain how a new contact is added on the “Contacts” page.

To add a new contact, proceed as follows:

1. Open the “Contacts” page.

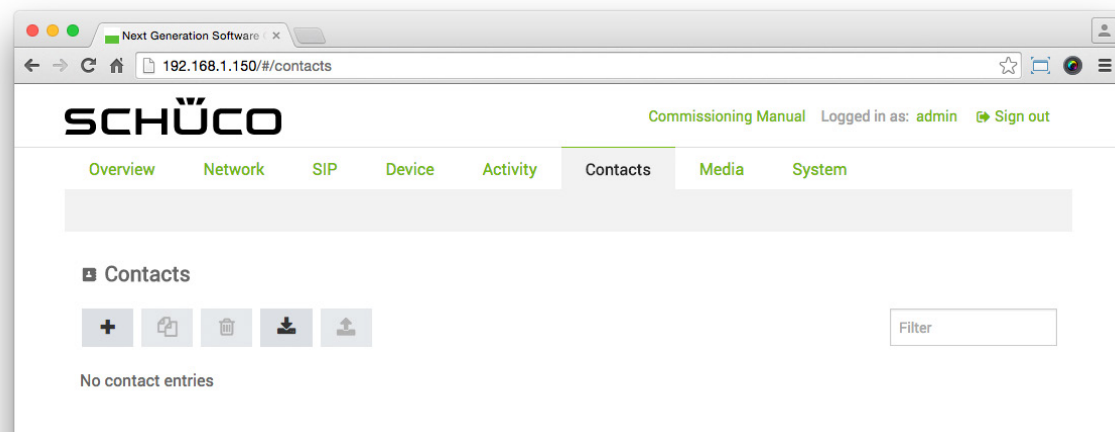

1. Click on .
2. Enter the name of the contact in the “First name” and “Surname” fields.
3. Enter the SIP telephone number of the contact in the “Destination” field.
4. Click on .

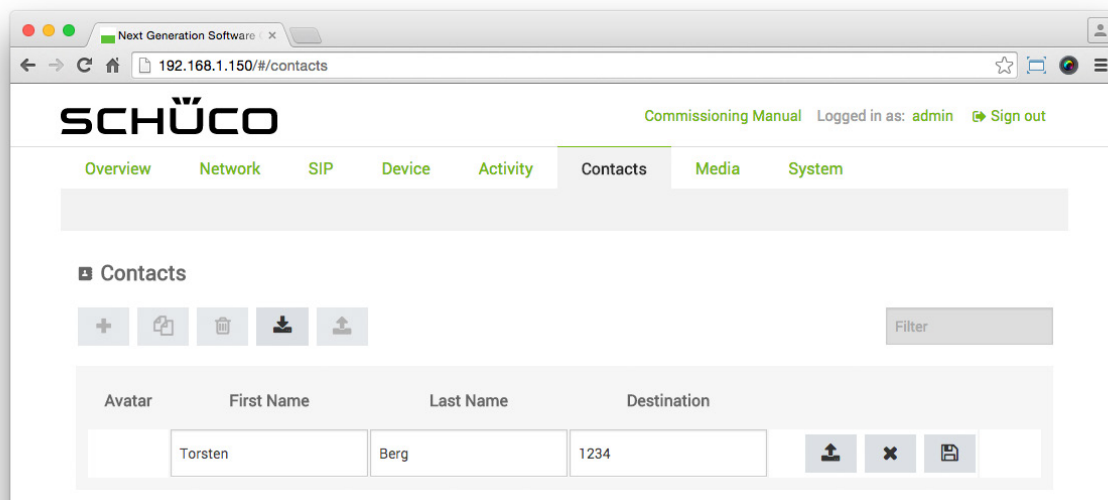

5. Select the desired profile picture and click on “Open”. Once the profile picture has been uploaded, the new contact is automatically saved.

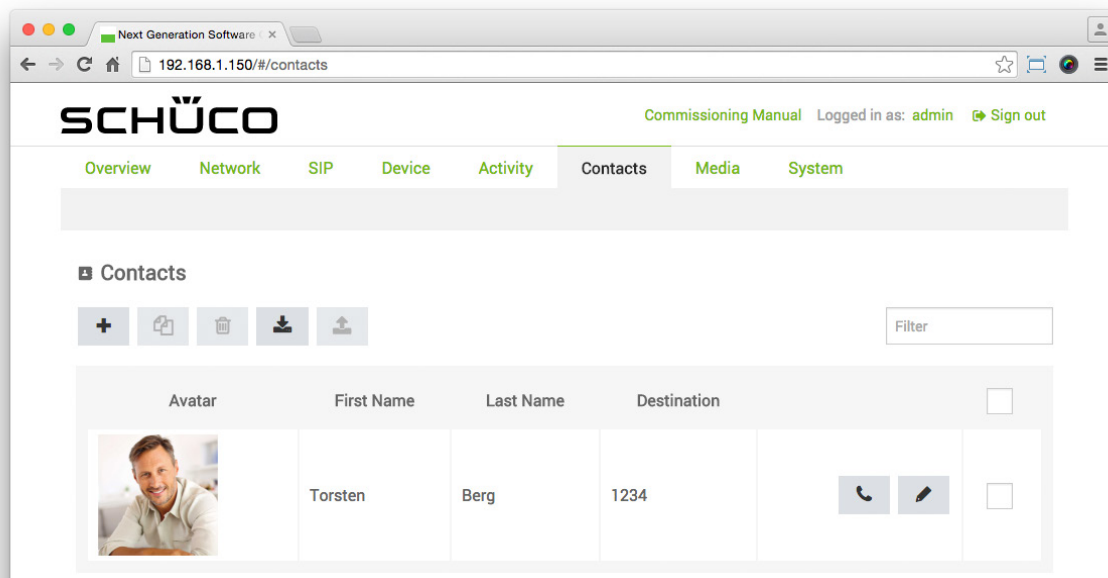
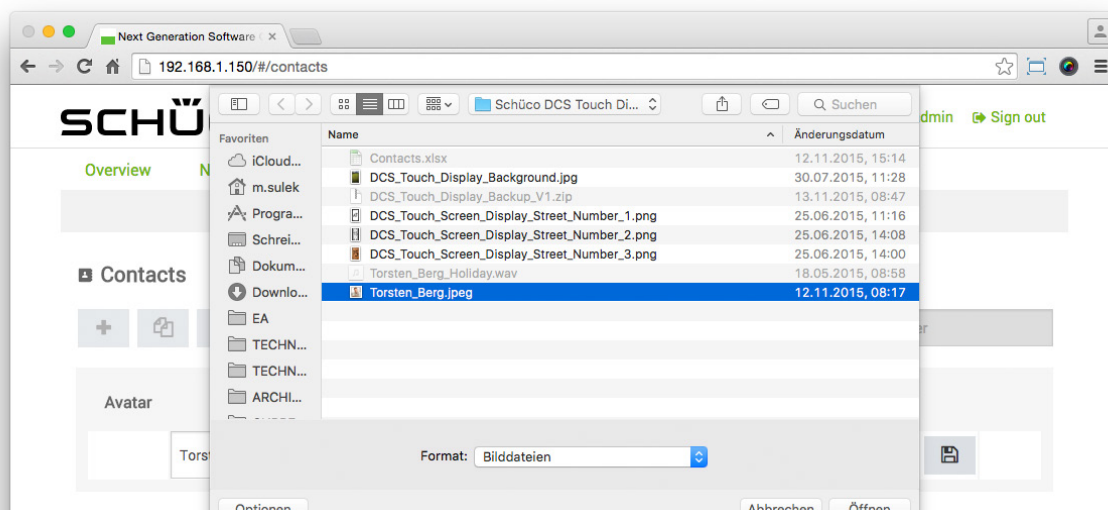



9.12.3. Exporting contacts

The following example will help to explain how contacts that have already been created can be exported as an XLSX file.

To export contacts, proceed as follows:

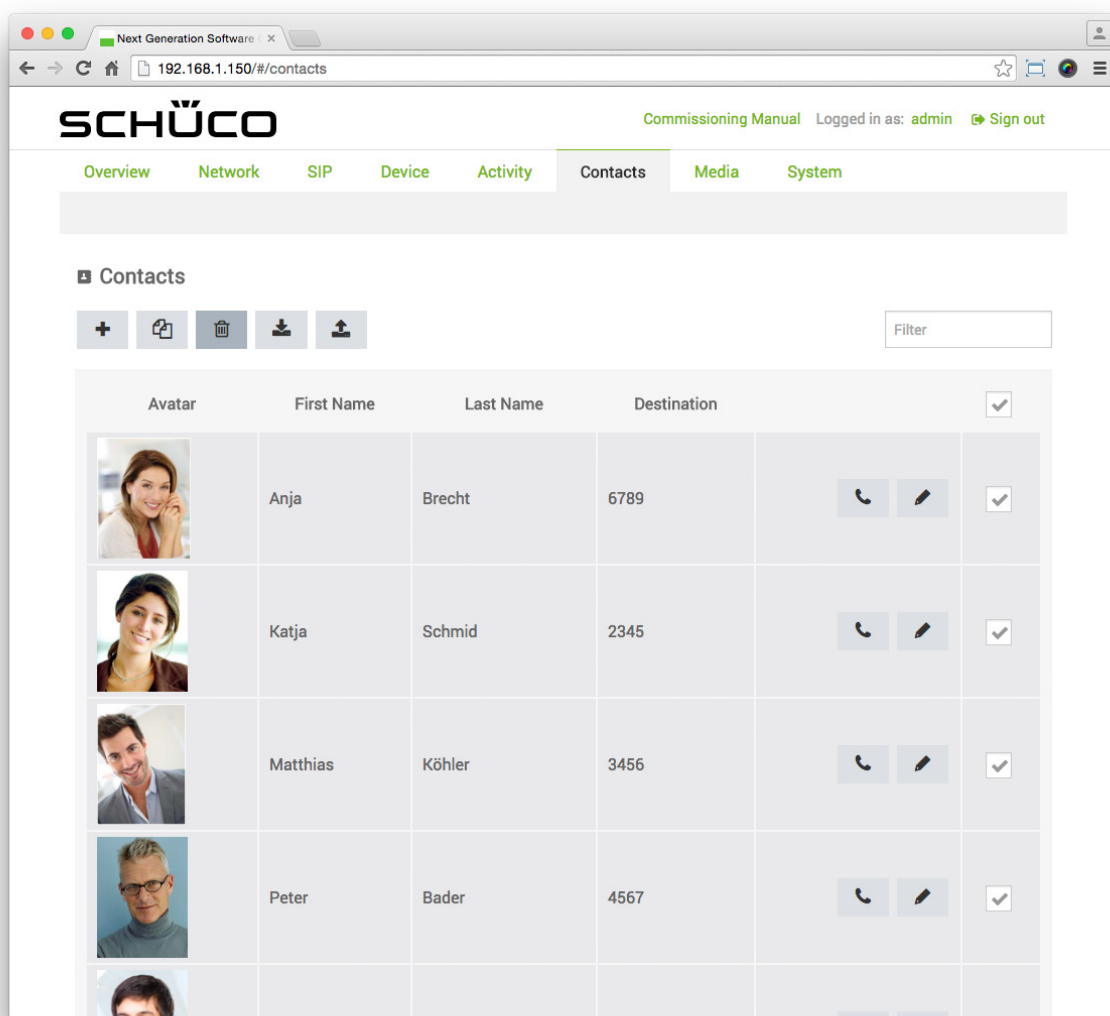
1. Open the “Contacts” page.
2. Check the checkboxes of the contacts which you would like to export.



3. Click on .
4. Assign a meaningful name to the exported XLSX file (e.g. “DCS_Touch_Display_Contacts_V1.xlsx”)

9.12.4. Kontakte importieren

The following example will help to explain how contacts can be imported from an XLSX file.

To this end, the details of the contacts must be entered into the columns of an XLSX file as follows:

- Column “A”: Name and surname, separated by a minus sign (this column can remain blank; is only generated during export).
- Column “B”: SIP telephone number of the contact.
- Column “C”: First name of the contact.
- Column “D”: Surname of the contact.
- Column “E”: Must remain blank.
- Column “F”: Image link for the contact (this column must remain blank, since images cannot be uploaded with the XLSX file; is only generated during export).

	A	B	C	D	E	F	G	H	I	J
1	Jens-Mustermann	1235	Jens	Mustermann		47DEQpj8HBSa+/TImW+5JCeuQeRkm5NMpJWZG3hSuFU=				
2	Lydia-Muster	1236	Lydia	Muster		47DEQpj8HBSa+/TImW+5JCeuQeRkm5NMpJWZG3hSuFU=				
3	Max-Mustermann	1234	Max	Mustermann		47DEQpj8HBSa+/TImW+5JCeuQeRkm5NMpJWZG3hSuFU=				
4	Musterfirma-Mustermeyer	1237	Musterfirm	Mustermeyer		47DEQpj8HBSa+/TImW+5JCeuQeRkm5NMpJWZG3hSuFU=				
5	Sandra-Musterfrau zu Musterhausen	1237	Sandra	Musterfrau zu Musterh		47DEQpj8HBSa+/TImW+5JCeuQeRkm5NMpJWZG3hSuFU=				
6										



INFORMATION

Importing images

It is not possible to also import profile pictures with the XLSX file. For each contact imported via an XLSX file, profile pictures must be uploaded subsequently.

To import contacts, proceed as follows:

1. Open the “Contacts” page.

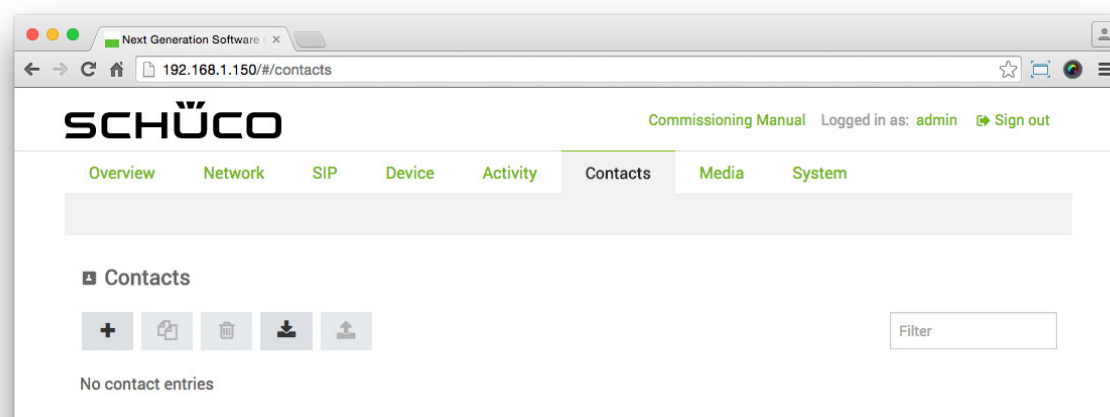

2. Click on  .
3. Select the desired XLSX file and then click on “Open”. The selected file is imported.

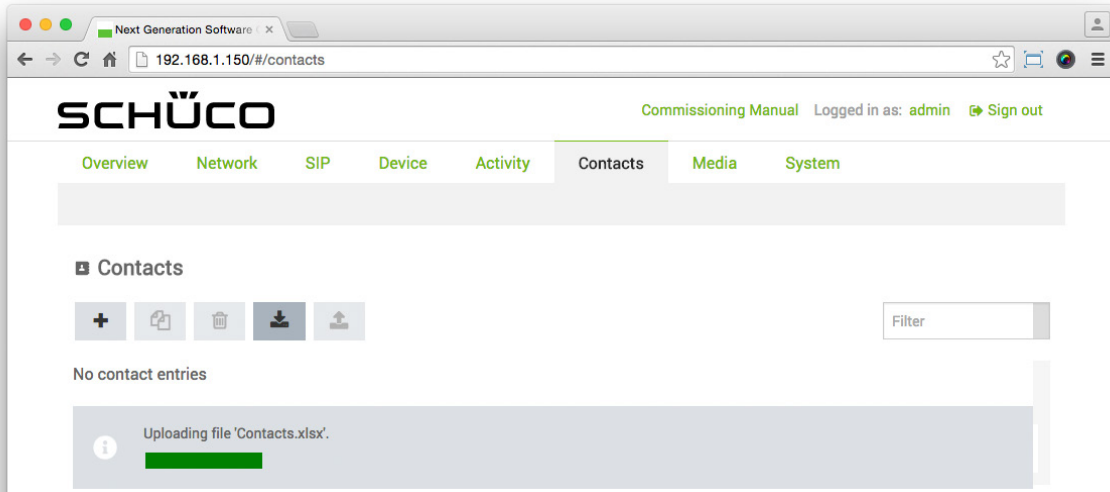
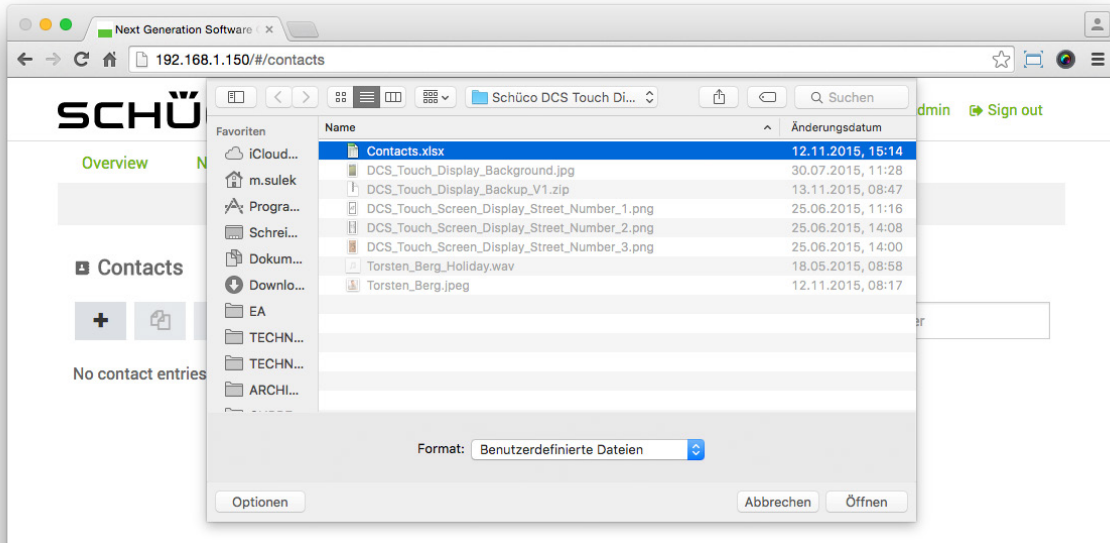

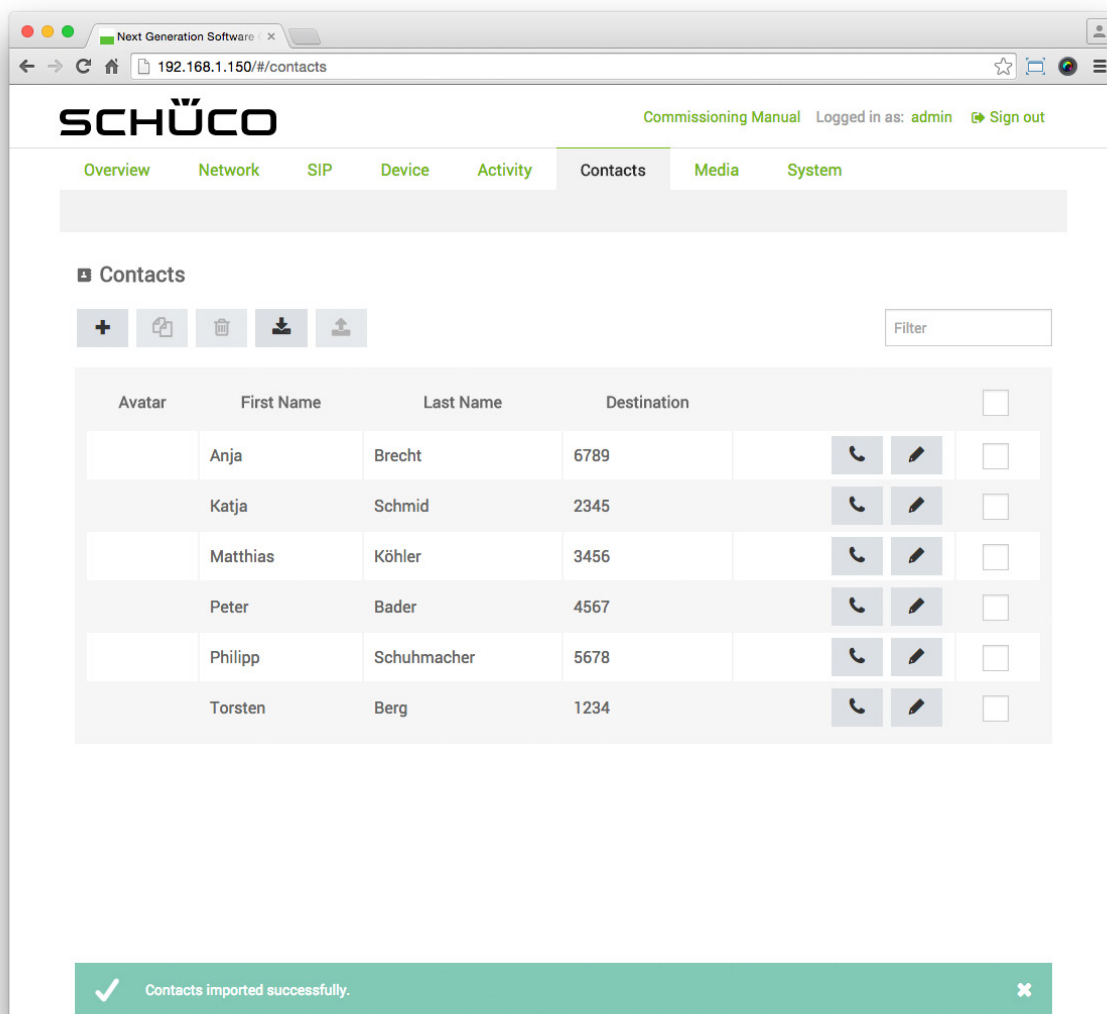

4. If necessary, edit the imported contacts by uploading a profile picture for the respective contact, for example (see “9.15.1 Editing a contact”).

9.12.5. Editing a preconfigured contact

On the “Contacts” page, two preconfigured contacts have already been created for the DCS Touch Display in the factory, which are also displayed in the “Doorbell list” view. These can be added to, changed or deleted as required.

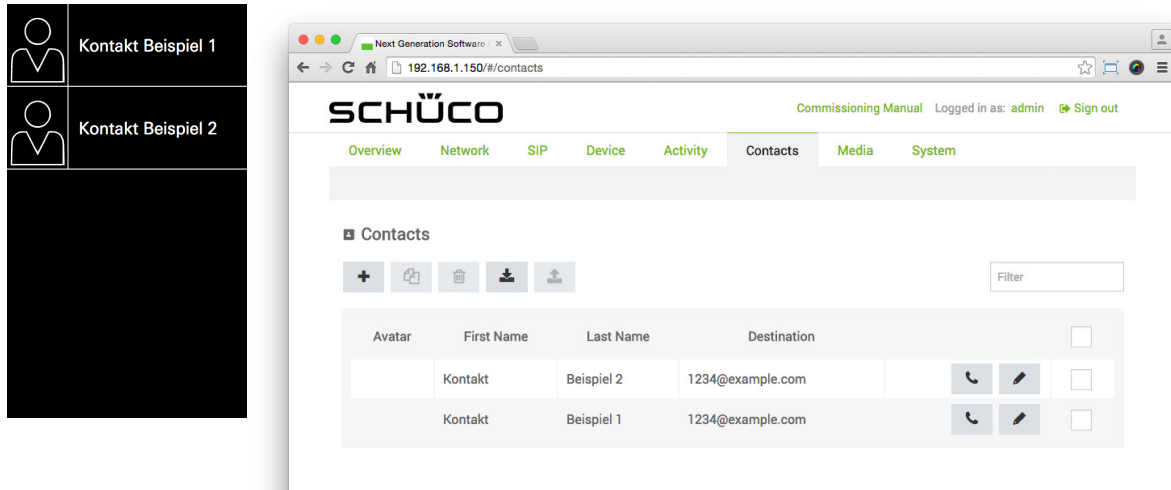

The following example will show you how to edit one of the two preconfigured contacts.



INFORMATION

Deleting a preconfigured contact

As long as a contact is connected to a function, it cannot be deleted. In order to be able to delete one or both of the preconfigured contacts, all of the connected activities and action sequences must be changed or deleted.

To edit a preconfigured contact, proceed as follows:

1. Click on .
2. Enter the name of the contact in the “First name” and “Surname” fields.
3. Enter the SIP telephone number of the contact in the “Destination” field.

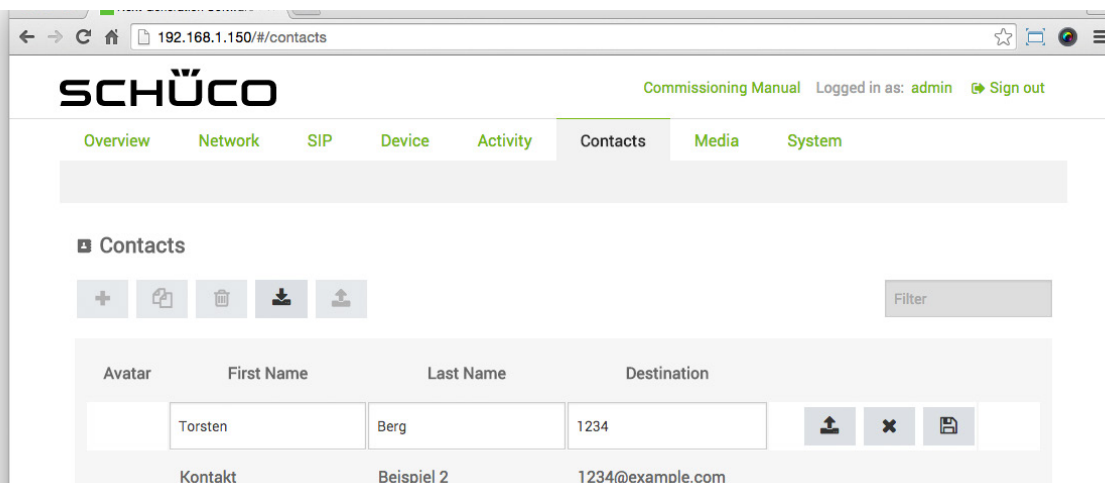

- Click on .
- Select the desired profile picture and click on “Open”. Once the profile picture has been uploaded, the new contact is automatically saved.

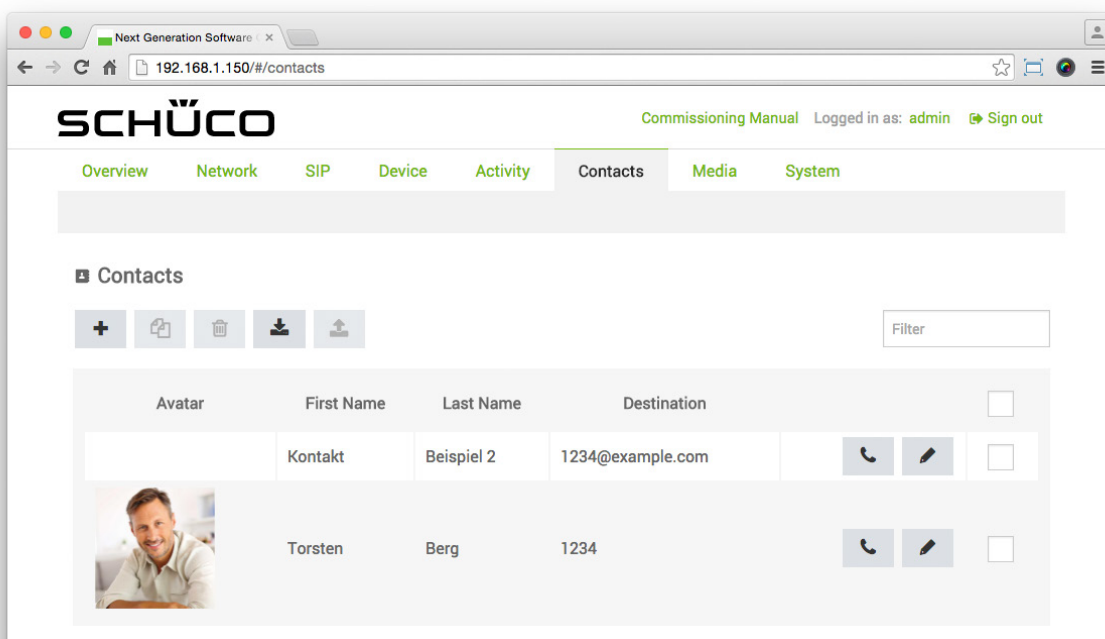
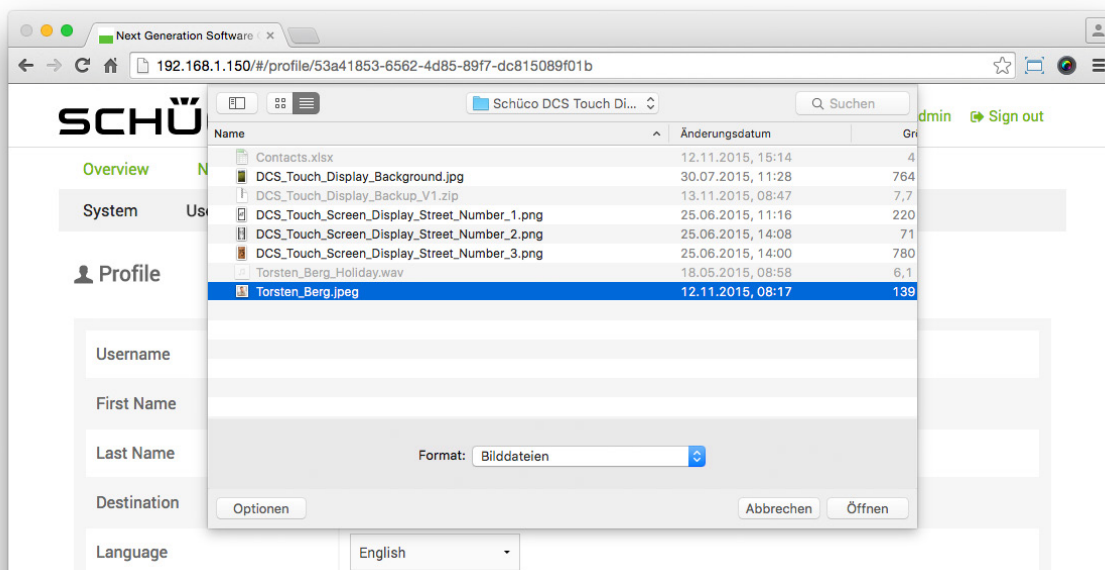

- In the menu bar, click first on “Device” and then on “Buttons”.

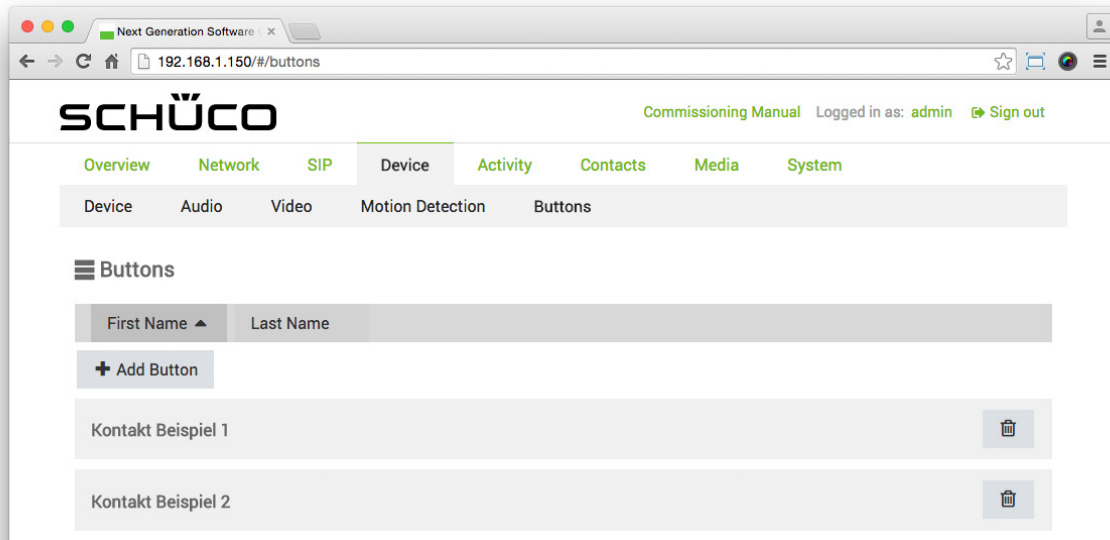

7. Click on the button of the contact that has just been amended to display the settings area.
8. In the “Select contact” selection list, first select another contact at random and then return to the contact that has just been amended in order to reconnect it. The “Overwrite settings?” dialog box appears.

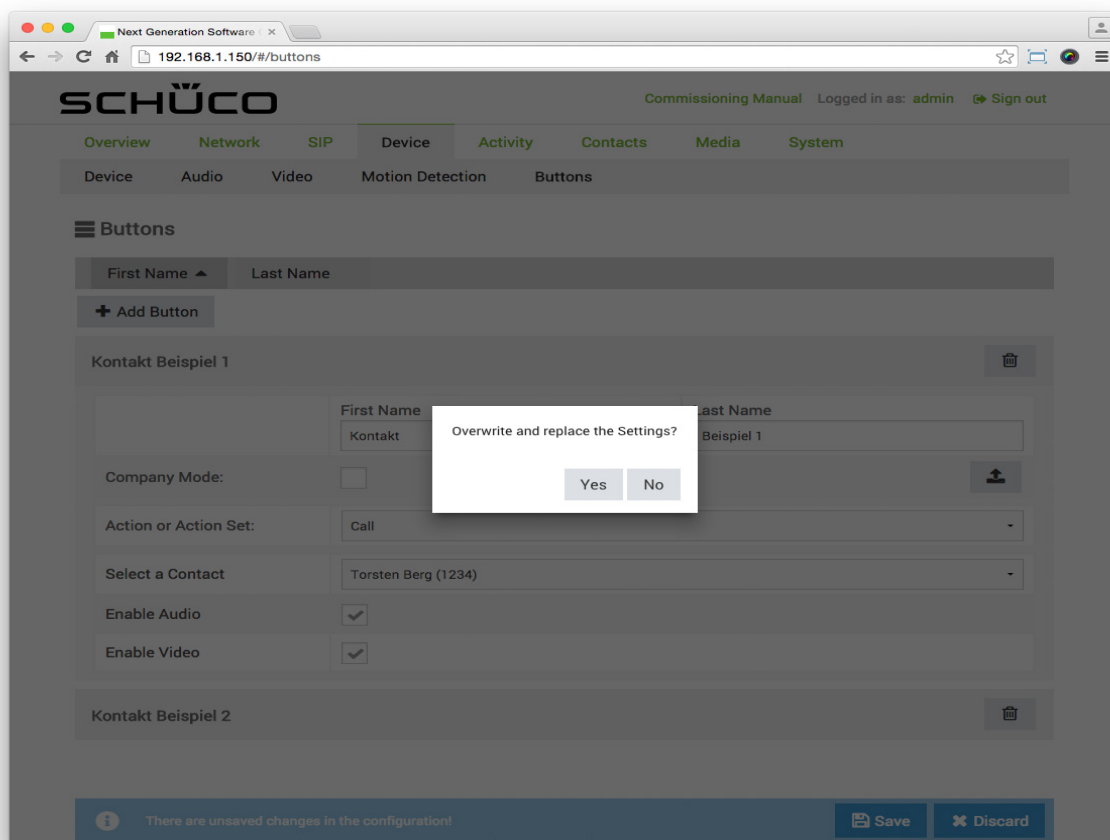

9. Click on “Yes” to automatically copy over the fields “First name” and “Surname” as well as the profile picture of the contact.

10. Ensure that the checkboxes “Activate audio” and “Activate video” are checked to enable audio and images for a call. If you do not want to use video transmission, uncheck the “Activate video” checkbox.

11. Click on .

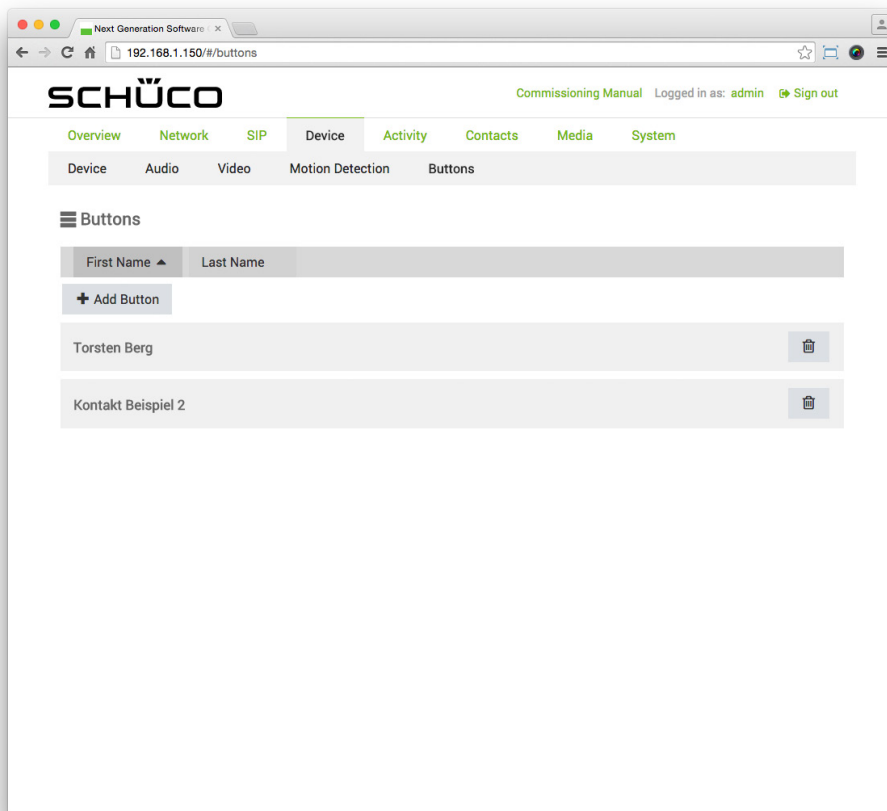

9.12.6. Peer-to-Peer

To enable a Peer-to-Peer connection (P2P) to an SIP-compatible end device, the address of the end device itself must be entered in the “Destination” field of the corresponding contact on the “Contacts” page instead of the address assigned through an SIP server. At the same time, putting an “@” before the address is recommended (see below). Addresses can be entered in two possible variants:

- Without DNS server: An IP address must be entered as the address of the end device (e.g. “@192.168.1.151”).
- With DNS server: Either an IP address or a host name can be entered as the address of the end device (e.g. “@192.168.1.151” or “@example.name”). When assigning a host name, ensure that this is recorded accordingly by a DNS server in the building’s network.

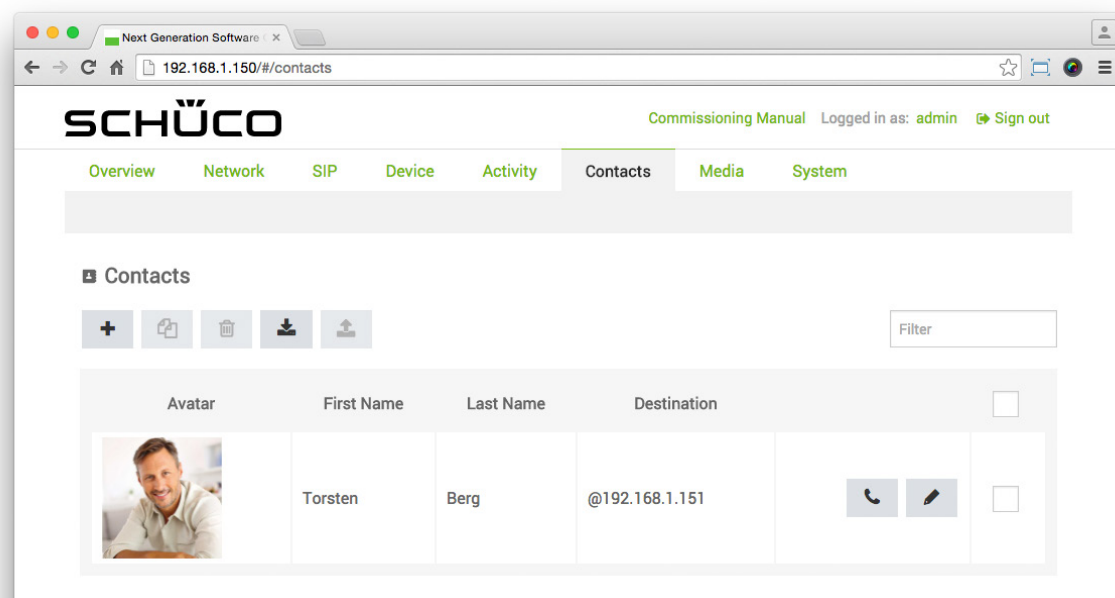

INFORMATION

What is Peer-to-Peer?

A Peer-to-Peer connection allows direct communication between two equivalent end devices. In this way, no SIP server is needed in this case and the DCS Touch Display can be operated without a registrar if required (see „9.8 SIP“).

For a Peer-to-Peer connection, both devices must be part of the same network.

9.12.7. Hidden contact

The following example explains how a call can be made to an existing contact exclusively by means of entering the access code. The aim here is to allow visitors to be able to make a call to a hidden contact only by entering the access code in the “Code entry” view, in order to avoid unwanted calls.



INFORMATION

Hidden contact in addition to the doorbell list

It is possible to both display contacts in the „Doorbell list“ view and use hidden contacts. To do so, the relevant contacts which are to be displayed in the „Doorbell list“ view must be configured as buttons (see „7.9 Buttons“) and each hidden contact configured accordingly (as follows).

Proceed as follows to configure an existing contact as a hidden contact:

1. Open the “Action sequences” page via “Activity”.

2. Click on 

3. Enter the name of the contact in the “Name” field.

4. Click on 

5. Click on 

6. Click on 

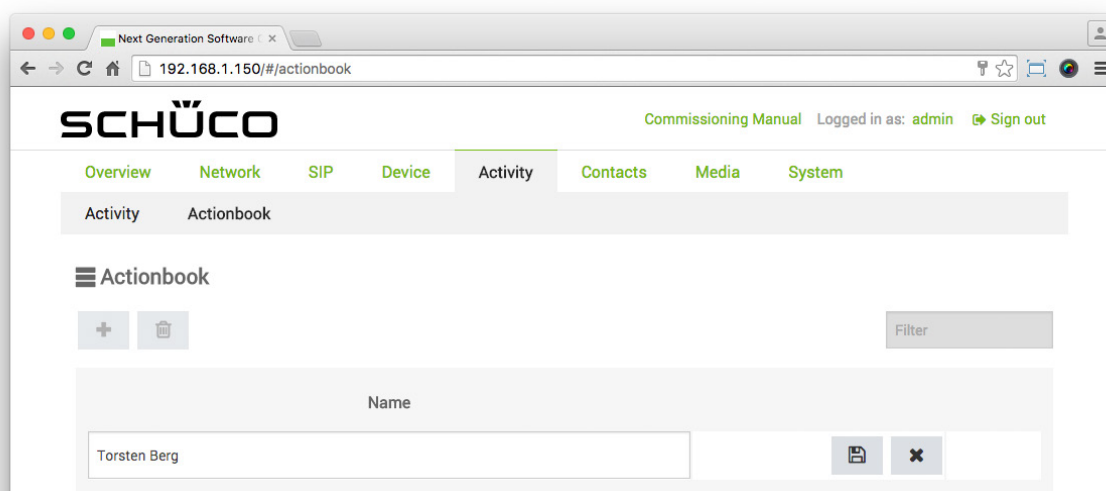

7. In the “Action” drop-down list, select the “Call” option.

8. In the “Select contact” drop-down list, select the corresponding contact.

9. Uncheck the “Activate audio” and/or “Activate video” checkboxes as required.

10. Click on  Save

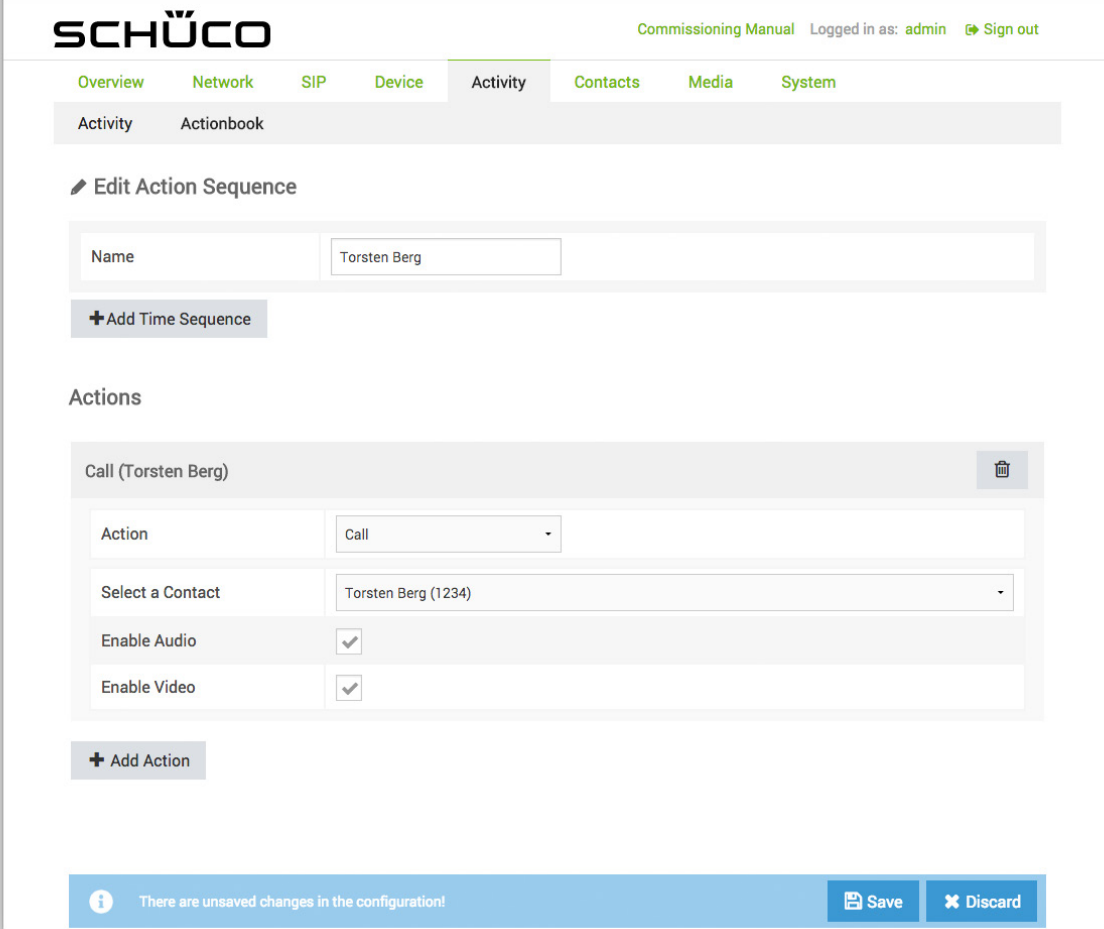

SCHÜCO Commissioning Manual Logged in as: admin Sign out

Overview Network SIP Device **Activity** Contacts Media System

Activity Actionbook

 Edit Action Sequence

Name



+Add Time Sequence

Actions

Call (Torsten Berg) 

Action	Call
Select a Contact	Torsten Berg (1234)
Enable Audio	<input checked="" type="checkbox"/>
Enable Video	<input checked="" type="checkbox"/>

+ Add Action

 There are unsaved changes in the configuration!  Save  Discard

11. Via “System”, open the “User administration” page.

12. Click on 

13. Enter the name of the contact in the “Username” field.

14. Click on 

15. Click on 

16. to generate a four or six-digit access code.

17. Check the checkbox of the action sequence just created.

18. Click on  Save



INFORMATION

Multiple hidden contacts

If multiple hidden contacts exist, there are three options which can also be used in combination: Each hidden contact is assigned an individual access code (described as follows). All hidden contacts are assigned a common access code, whereby a user is stored and all checkboxes for hidden contacts are activated for them in the „Profile“ section under „Permitted action sequences“ (see „7.16.2 Profile“). Hidden contacts are assigned a common access code in groups, whereby multiple users are stored and the corresponding checkboxes for hidden contacts are activated for the respective user in the „Profile“ section under „Permitted action sequences“ (see „7.16 User administration“). If a call can be made to several hidden contacts by entering an access code, only the text of the relevant action sequence is shown in the „Select action“ view; in the „Select action“ view, no profile images can be displayed, unlike in the „Doorbell list“ view.

9.13. Media

On the “Media” page, it is possible to manage basic audio files.

The following options are available in the “Tones” section:

 : This bar shows how much memory is available for audio files (max. 15 MB).

 : Click on this button to upload an audio file.

 : Click on this button to delete one or more audio files.

 : Click on this button to download the corresponding audio file to the computer.

 : Click on this button to play the corresponding audio file (playback via the computer).

 : Click on this button to edit a contact that has already been created.

: Check the checkboxes of all contacts which you would like to copy, delete or export.

: Enter a search term in this field and press the “Enter” button to search for a contact that has already been created.

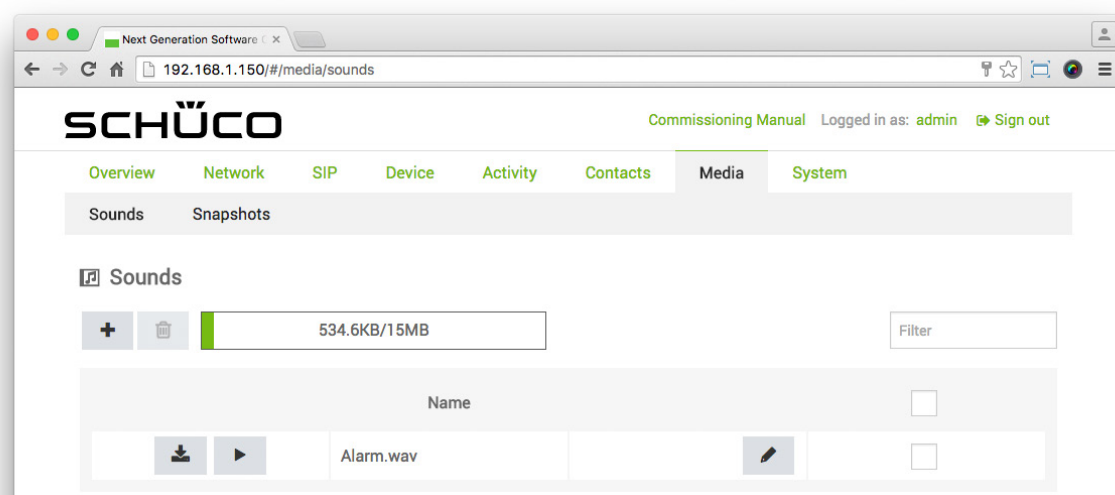

INFORMATION

Alarm.wav

The audio file „Alarm.wav“ is already on the DCS Touch Display as standard. This is used for providing an acoustic alarm signal when the alarm mode is activated.

9.13.1. Adding an audio file

The following example will help to explain how an audio file can be uploaded to the DCS Touch Display.



INFORMATION

Audioeigenschaften

Auf das DCS Touch Display können nur Dateien in den Formaten WAV und MP3 geladen werden. Die maximale Dateigröße beträgt 6 MB.

To upload an audio file, proceed as follows:

1. Open the “Tones” page via “Media”.

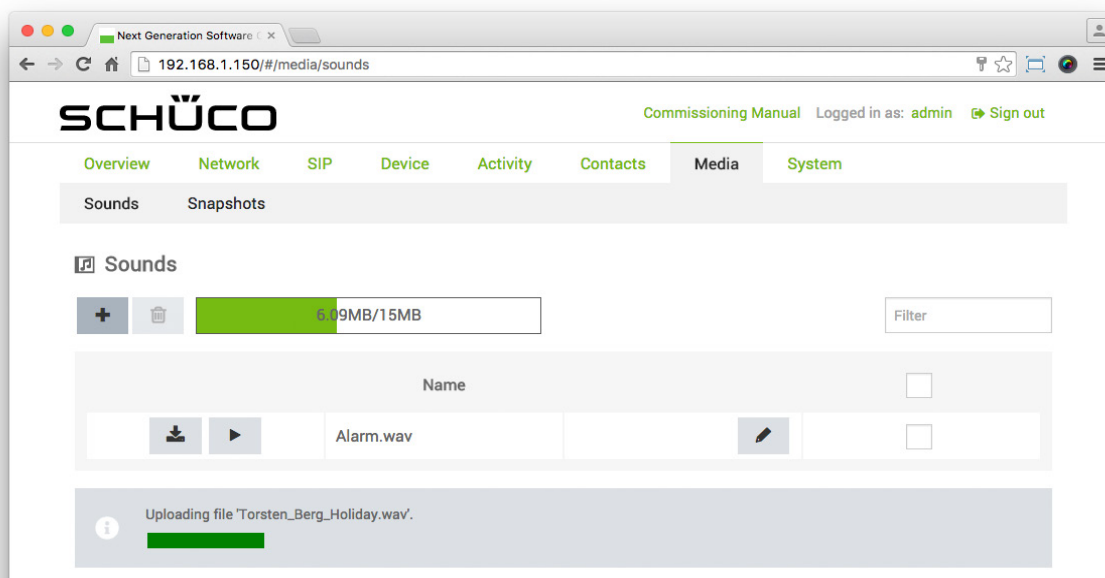

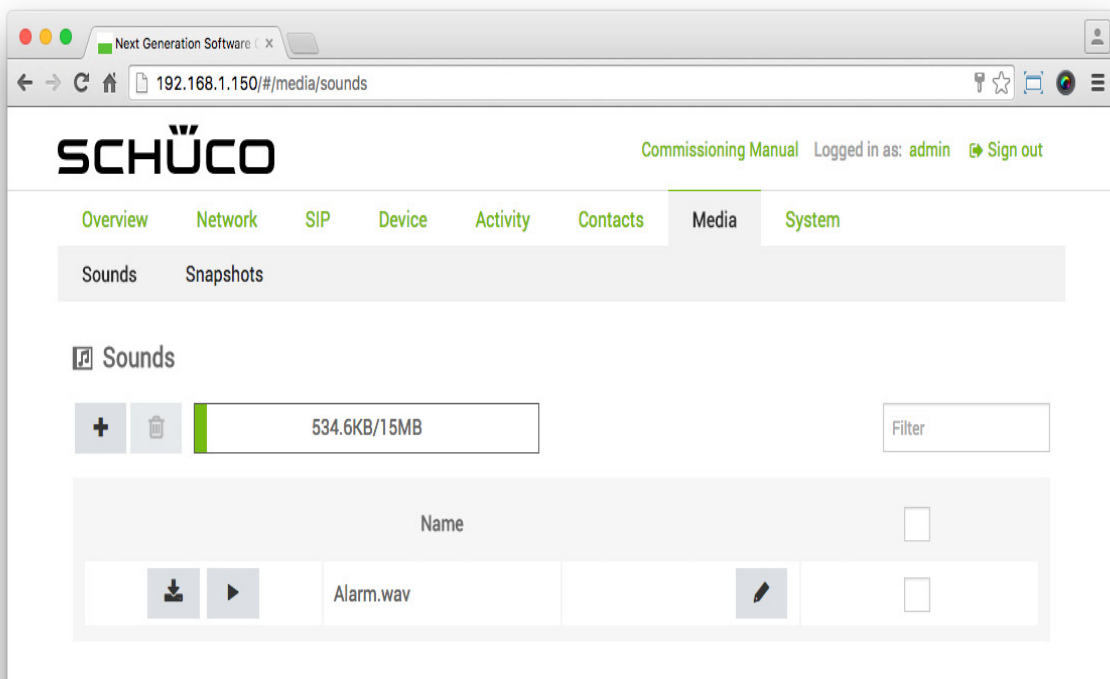
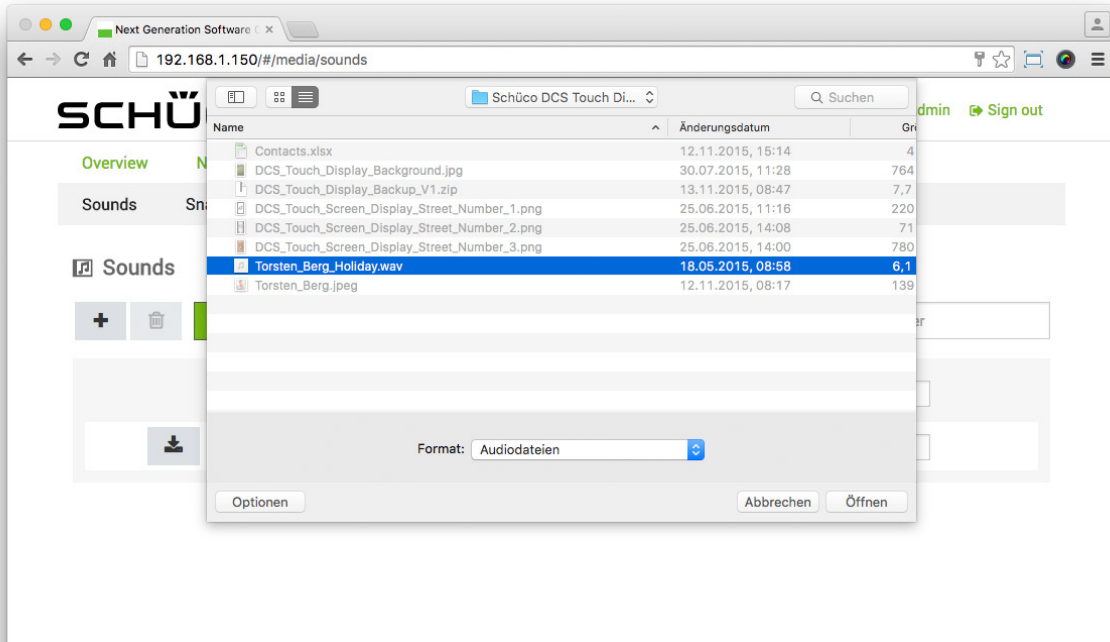

2. Click on  .
3. Select the desired WAV or MP3 file and then click on “Open”.



9.13.2. Photos

On the “Photos” page, all snapshots of the DCS Touch Display are stored which were produced via the internal camera.

The following options are available in the “Photos” section:

-  1.07MB/15MB : This bar shows how much memory is available for image files (max. 50 MB).
-  : Click on this button to delete one or more audio files.
-  : Check the checkboxes of all contacts which you would like to delete.
- : Enter a search term in this field and press the “Enter” button to search for a contact that has already been created.



INFORMATION

Downloading a snapshot

Click directly on the image of the snapshot to download it.

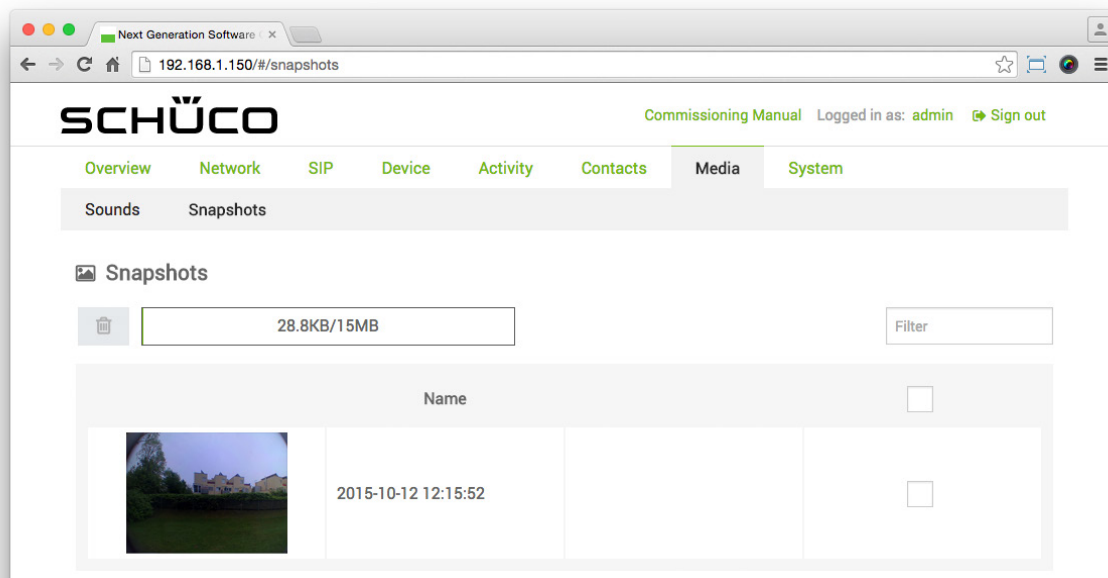

9.14. System

On the “Systems” page it is possible to make basic settings for the DCS Touch Display.

The screenshot displays the Schüco web interface for system configuration. The browser address bar shows the URL `192.168.1.150/#/system`. The page header includes the Schüco logo, a link to the Commissioning Manual, and the user is logged in as 'admin' with a 'Sign out' option. The main navigation menu includes Overview, Network, SIP, Device, Activity, Contacts, Media, and System. The System tab is selected, and a sub-menu shows System, User Management, Codecs, and Remote Maintenance. The System section contains buttons for Restore Factory Settings, Reboot Application, Reboot Device, and Update Device. The Configuration section has Backup and Restore buttons. The Device Locale is set to Germany and the Device Language to English. Under Time and Date, the System Time is 14:51:10, the System Date is 14.04.2016, and the Time Zone is Europe/Berlin. The Email configuration section includes input fields for Sender Name, Sender Email Address, SMTP Server Address, SMTP Server Port, a checkbox for Use TLS, Username, and Password.

9.14.1. System

The following options are available in the “System” section:

- **Restore Factory Settings** : Click on this button to restore the factory settings.
- **Reboot Application** : Click on this button to restart the application (the software of the DCS Touch Display).
- **Reboot Device** : Click on this button to restart the device (both the hardware and software of the DCS Touch Display).
- **Update Device** : Click on this button to update the device with more recent software.



INFORMATION

Performing a factory reset

All data is lost when a factory reset is performed - including network settings. For this reason, we recommend exporting the configuration as a backup before restoring the factory settings. If the DCS Touch Display is additionally connected to an IP secure connector, both devices must be paired to one another once again so that it is possible to use the DCS Touch Display again in the network (see „5.1 Pairing the IP secure connector with the DCS Touch Display“).

Restoring, restarting and updating

It may take a few minutes to restore factory settings, restart the application or device and update the software. During this time, it is not possible to access the web interface and the screen of the DCS Touch Display is black.

9.14.2. Configuration

In the “Configuration” section, basic settings such as device language, location and time can be made and the configuration exported and imported.

The following options are available in the “Configuration” section:

- **Backup** : Click on this button to export the configuration in ZIP format.
- **Restore** : Click on this button to import a configuration which has already been exported in ZIP format.
- **Device location**: In this selection list, select the country in which the DCS Touch Display is installed (“Germany” is the default).
- **Device language**: In this selection list, select the screen language for the DCS Touch Display (“German” is the default). The following options are available for this:
 - German
 - English
- **System time**: Enter the current time in this field (is automatically adjusted by means of the NTP).
- **System date**: Enter the current date in this field (is automatically adjusted by means of the NTP).
- **Time zone**: In this selection list, select the time zone in which the DCS Touch Display is installed (“Europe/Berlin” is the default).

9.14.3. E-mail settings

In the “E-mail settings” section, an SMTP e-mail address can be entered. This function is used with the anti-theft device, for example: As soon as an attempt is made to remove the DCS Touch Display improperly, an e-mail with the notification “At this moment your DCS Touch Display is being stolen” can be sent (see “9.14.5 Anti-theft sequence”).

The following options are available in the “E-mail settings” section:

- Sender name: Enter the name of the sender in this field (e.g. “DCS Touch Display”).
- Sender’s e-mail address: Enter the e-mail address of the sender in this field.
- SMTP server address: Enter the address of the SMTP server belonging to the e-mail address in this field.
- SMTP port: Enter the port number of the SMTP server belonging to the e-mail address in this field.
- Use TLS: Check this checkbox to send e-mails from the DCS Touch Display in encrypted form.
- User name: Enter the user name belonging to the e-mail address in this field.
- Password: Enter the password belonging to the e-mail address in this field.

9.14.4. Exporting the configuration

The following example will help to explain how the configuration currently called up can be exported.

To export the current configuration, proceed as follows:

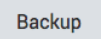
1. Via “System”, open the “System” page.
2. Click on . The file “backup.zip” is created and stored in the “Downloads” folder on your computer.
3. Assign a meaningful name to the ZIP file that has just been exported (e.g. “DCS_Touch_Display_Backup_V1.zip”)

9.14.5. Importing the configuration

The following example will help to explain how a configuration that has previously been exported can be imported.

To import the current configuration, proceed as follows:

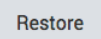
1. Via “System”, open the “System” page.
2. Click on .

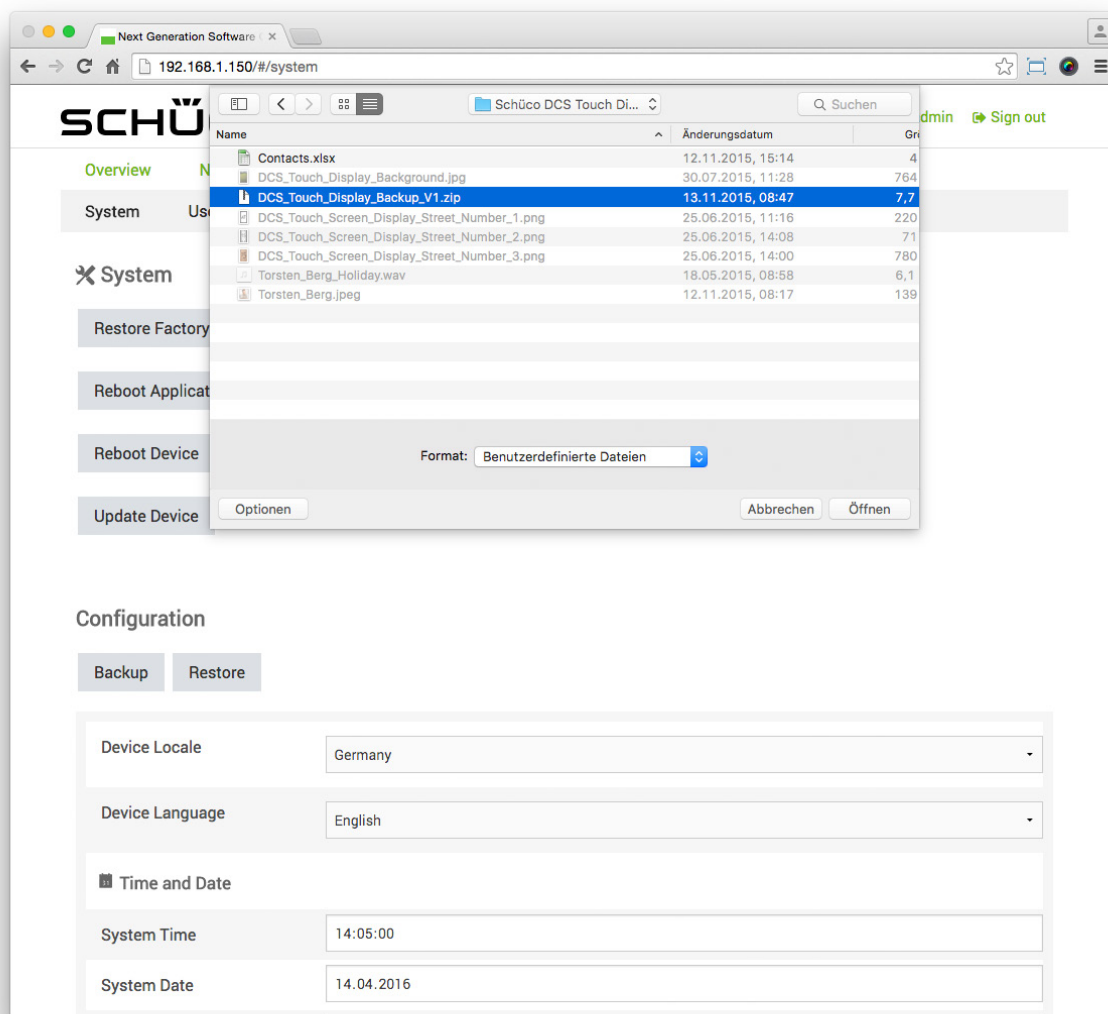

3. Select the desired ZIP file and then click on “Open”. The “Overwrite settings?” dialog box appears.
4. Leave the “Network settings” checkbox checked if you do not want the network settings to be overwritten when importing a configuration. Otherwise, uncheck this checkbox.

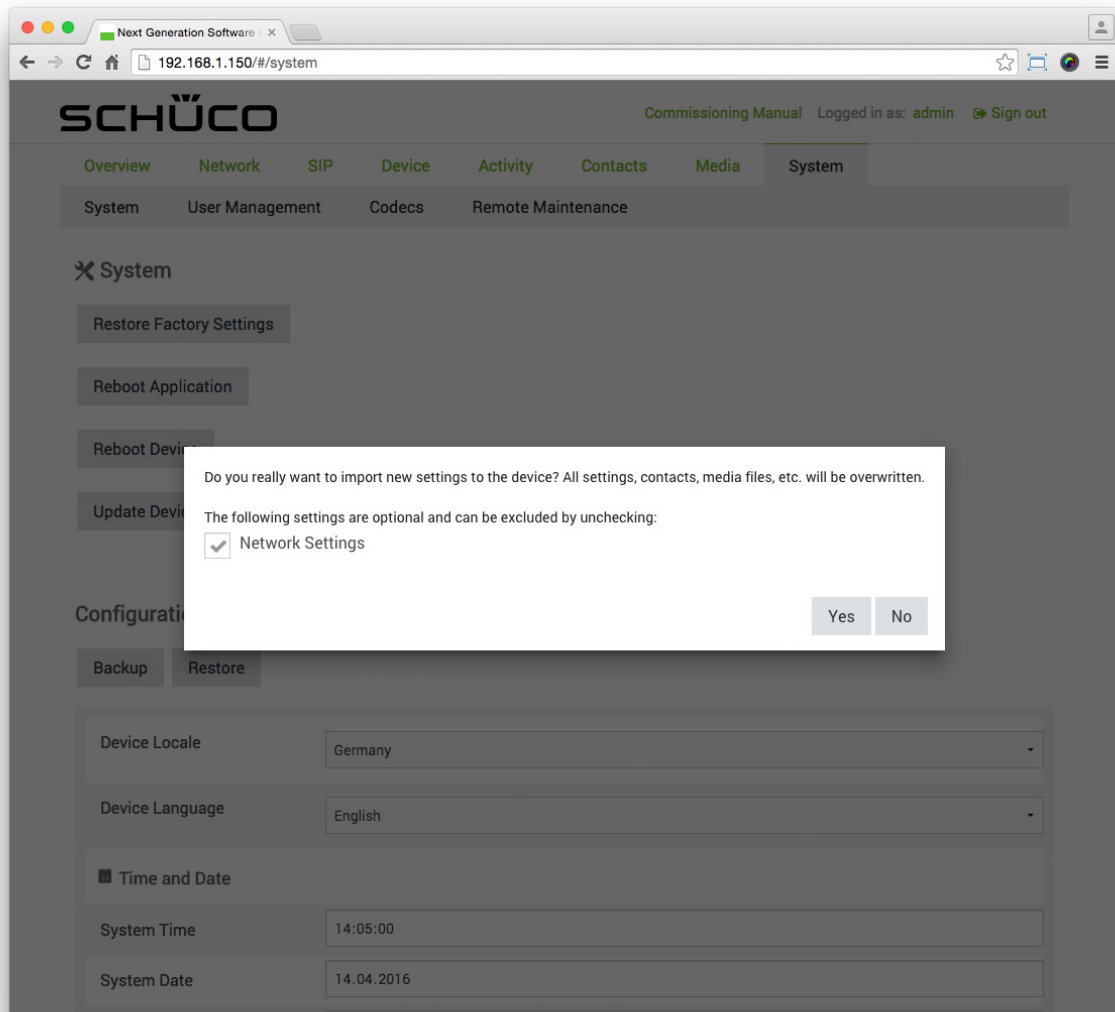

5. Click on "Yes". The ZIP file will now be imported and the DCS Touch Display will subsequently be restarted.

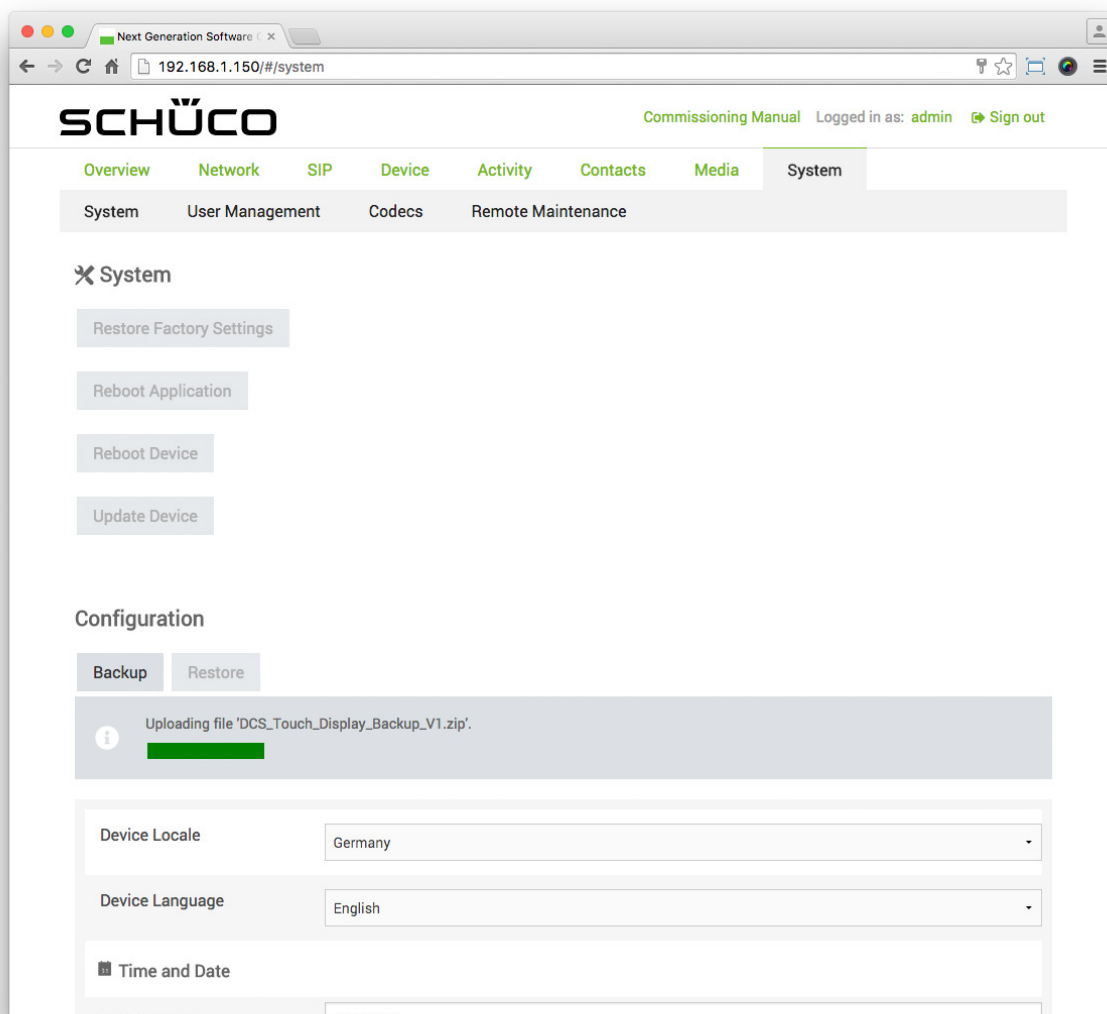

6. Wait until the DCS Touch Display has performed a restart, and then log back into the web interface using the appropriate access data.

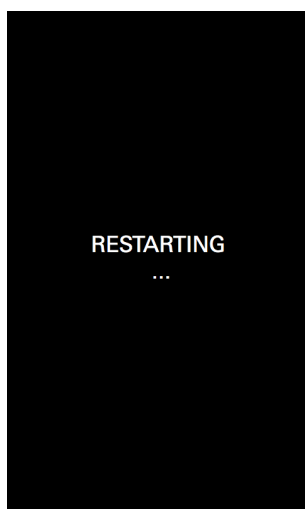

9.15. User administration

On the “User administration” page, it is possible to manage users for the DCS Touch Display and the web interface. Here a distinction is made between the sections “Users” and “Roles”. Under “Users”, the user data is managed, while the actions permitted are defined under “Roles”.

All contacts that have been entered on the “Contacts” page also appear as users on the “User administration” page.

The screenshot shows the Schüco web interface for user management. The browser address bar shows '192.168.1.150/#/user-management'. The page title is 'SCHÜCO' and the user is logged in as 'admin'. The navigation menu includes 'Overview', 'Network', 'SIP', 'Device', 'Activity', 'Contacts', 'Media', and 'System'. Under 'System', there are sub-menus for 'System', 'User Management', 'Codecs', and 'Remote Maintenance'. The 'User Management' section has tabs for 'Users' and 'Roles'. Below the tabs are buttons for adding (+) and deleting (trash) users, and a 'Filter' input field. A table lists the following users:

Username	Roles		
admin	• admin		<input type="checkbox"/>
Anja Brecht			<input type="checkbox"/>
Katja Schmid			<input type="checkbox"/>
Matthias Köhler			<input type="checkbox"/>
Peter Bader			<input type="checkbox"/>
Philipp Schuhmacher			<input type="checkbox"/>
Torsten Berg			<input type="checkbox"/>

9.15.1. Users

In the “Users” section, users can be created, edited and deleted. The users “admin”, “Contact example 1” and “Contact example 2” have already been created by default.

The following options are available in the “Users” section:

 : Click on this button to create a new user.

 : Click on this button to delete one or more users.



: Click on this button to edit a user that has already been created.



: Check the checkboxes of all contacts which you would like to delete.









: Enter a search term in this field and press the “Enter” button to search for a contact that has already been created.

9.15.2. Profile

As soon as you have clicked on  next to a user, you can edit the user.

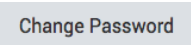
The following options are available in the “Profile” section:

- User name: Enter a user name (this does not have to match the fields “First name” and “Surname”).
- First name: Enter the first name of the user.
- Surname: Enter the surname of the user.
- Destination: Enter the SIP telephone number of the user.
- Language: Select the language of the user in the selection list. If this user logs in, the web interface is displayed in the language selected here. The following options are available for this:
 - German
 - English
- Access code: Here the access code for the “Code entry” view is displayed on the DCS Touch Display. If required, enter a four or six-digit access code into this field. The access code can only be entered manually by users who have been assigned the role “Code” (see “7.16.3 Roles”).
-  : Click on this button to generate a random four-digit access code.
-  : Click on this button to generate a random six-digit access code.
-  : Click on this button to upload a profile picture.
-  : Click on this button to delete a profile picture that has already been uploaded.
-  : Click on this button to change the user’s password for the web interface.
-  : Check the relevant checkboxes under “Roles” and “Permitted action sequences” to assign appropriate roles and action sequences to the user.



INFORMATION

Configuration view in “Permitted action sequences”

To enable the respective user to call up the “Configuration” view on the DCS Touch Display after entering their access code, the “Configuration view” checkbox under “Permitted action sequences” must be checked. For the user “admin”, this checkbox is checked by default.

SCHÜCO

[Commissioning Manual](#)
Logged in as: admin
➔ Sign out

Overview
Network
SIP
Device
Activity
Contacts
Media
System

System
User Management
Codecs
Remote Maintenance

Profile

Username	Torsten Berg
First Name	Torsten
Last Name	Berg
Destination	1234
Language	English ▾
Access Code	833716 4 6
Upload Avatar	<input type="button" value="Upload"/> <input type="button" value="Delete"/>

Roles

admin

Allowed Action Sequences

- Bewegungserkennung
- Bildspeicherung
- DCS Näherungstaster als Zentralruf
- Diebstahlüberwachung
- E-Öffner DCS Touch Display
- E-Öffner IP Secure Connector
- Konfigurationsansicht
- LED Spotlight DCS Touch Display
- LED Spotlight IP Secure Connector
- Safematic DCS Touch Display
- Safematic IP Secure Connector

9.15.3. Roles

In the “Roles” section, user roles can be created, edited and deleted. The user role “admin” has already been created by default.

Folgende Optionen stehen im Abschnitt „Benutzer“ zur Verfügung:



: Click on this button to create a new role.



: Click on this button to delete one or more roles.



: Click on this button to edit a role that has already been created.



: Check the checkboxes of all roles which you would like to delete.



: Enter a search term in this field and press the “Enter” button to search for a role that has already been created.

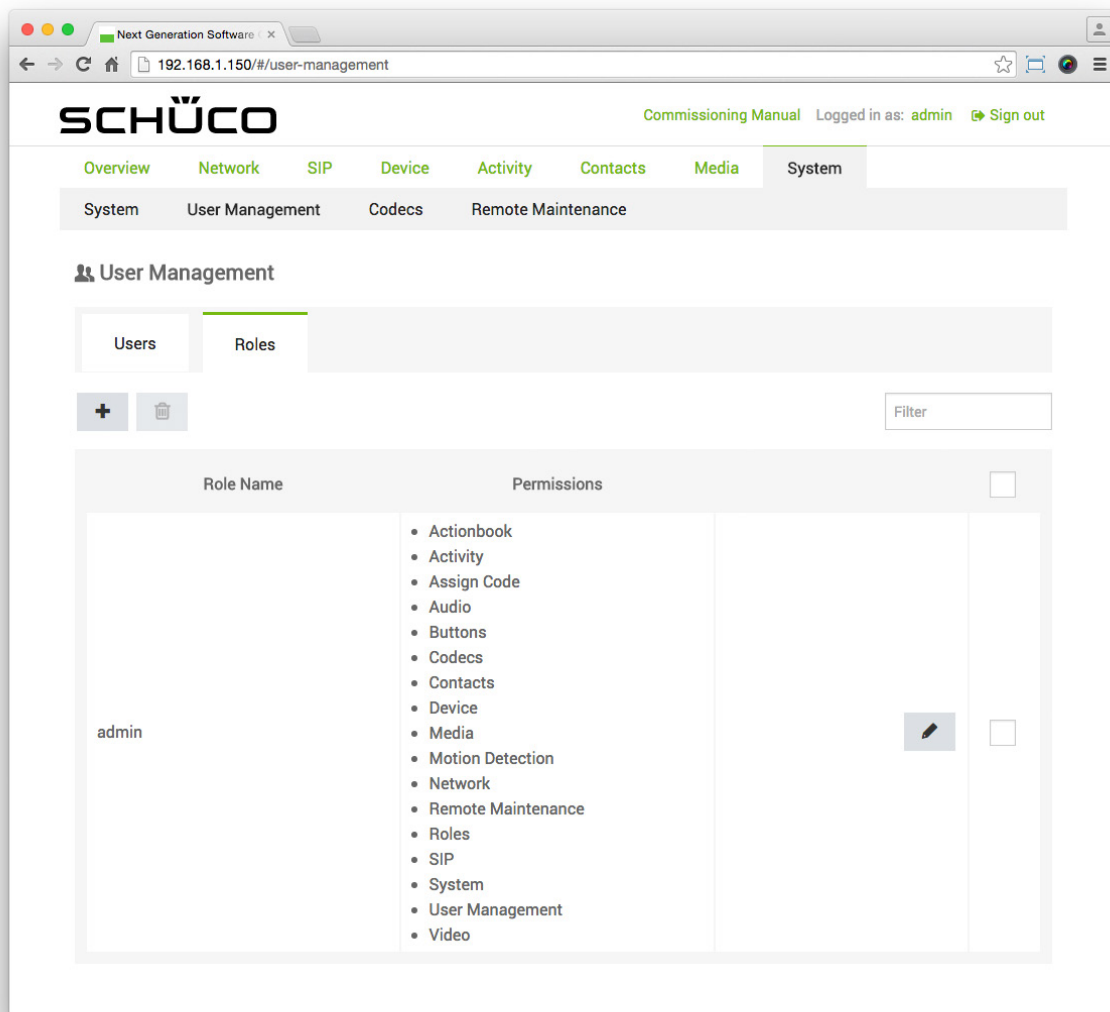



9.15.4. Editing a role

As soon as you have clicked on  next to a role, you can edit it.

The following options are available in the “Roles” section:

- Role name: Enter a meaningful role name.
 - Rights: Check the desired checkboxes which grant the rights for this role. The following options are available for this:
 - Action sequence: This enables the “Action sequences” page to be called up (see “7.11 Action sequences”).
 - Activity: This enables the “Activity” page to be called up (see “7.10 Activity”).
 - Audio: This enables the “Audio” page to be called up (see “7.6 Audio”).
 - User administration: This enables the “User administration” page to be called up (see “7.16 User administration”).
 - Motion detection: This enables the “Motion detection” page to be called up and the streaming of videos when the user is logged in with this role and the checkbox “Limit MJPEG streams” is activated (see “7.8 Motion detection” and “7.7 Video”).
 - Codecs: This enables the “Codecs” page to be called up (see “7.17 Codecs”).

- Remote maintenance: This enables the “remote maintenance” page to be called up (see “7.18 Remote maintenance”).
 - Free code entry: This enables the free entry of access codes in the “Access code” field. If this role has not been assigned, a random four or six-digit access code can only be generated via the buttons **4** and **6** (see “7.16.2 Profile”).
 - Device: This enables the “Device” page to be called up (see “7.5 Device”).
 - Contacts: This enables the “Contacts” page to be called up (see “7.12 Contacts”).
 - Media: This enables the “Media” page to be called up (see “7.13 Tones” and “7.14 Photos”).
 - Network: This enables the “Network” page to be called up (see “7.3 Network”).
 - Roles: This enables the “Roles” page to be called up (see “7.16.3 Roles”).
 - SIP: This enables the “SIP” page to be called up (see “7.4 SIP”).
 - System: This enables the “System” page to be called up (see “7.15.1 System”).
 - Buttons: This enables the “Buttons” page to be called up (see “7.9 Buttons”).
 - Video: This enables the “Video” page to be called up (see “7.7 Video”).
-  : Click on this button to delete the role.
 -  : Click on this button to save the role.

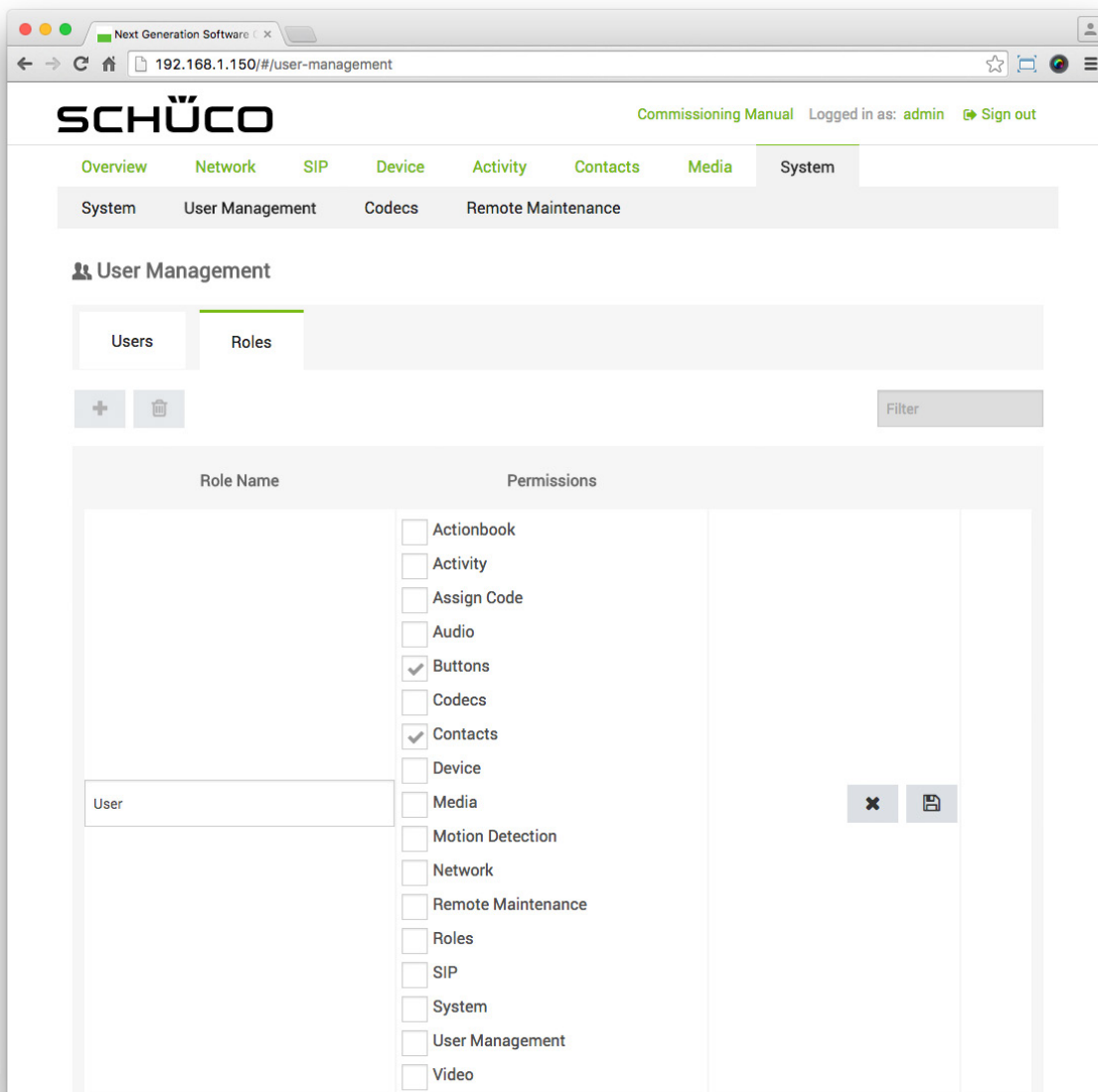



INFORMATION

Roles

The roles determine which pages and functions can be called up by a user. If a user is assigned a role, for example, in which “User administration” is not activated, this user cannot access the “User administration” page and cannot make any configurations.

9.15.5. Creating a user

The following example will help to explain how to create a user which you do not want to appear as a contact on the “Contacts” page. The aim is to assign a six-digit access code for the DCS Touch Display to the user, upload a profile picture and allow the “Configuration view” action sequence, which enables the user to access the “Configuration” view directly on the screen of the DCS Touch Display.

To create a user, proceed as follows:

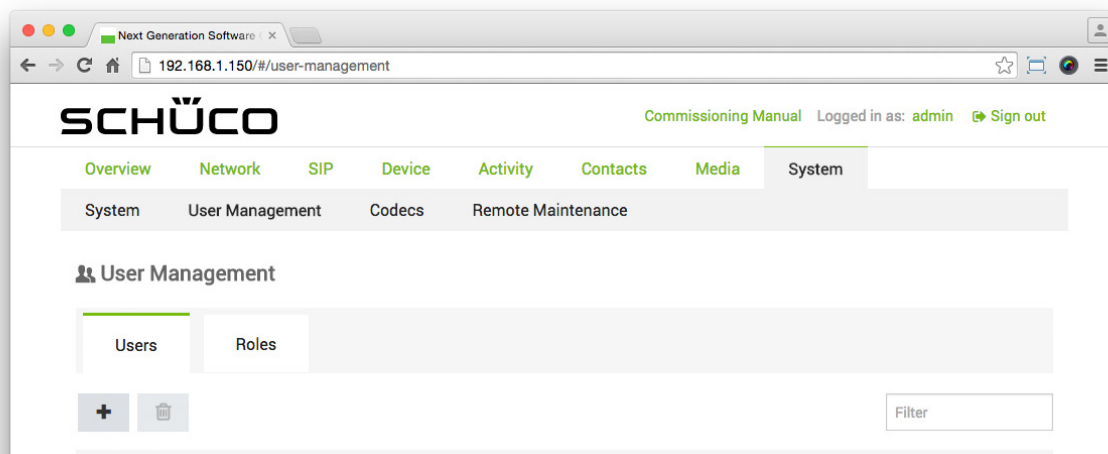

1. Via “System”, open the “User administration” page.

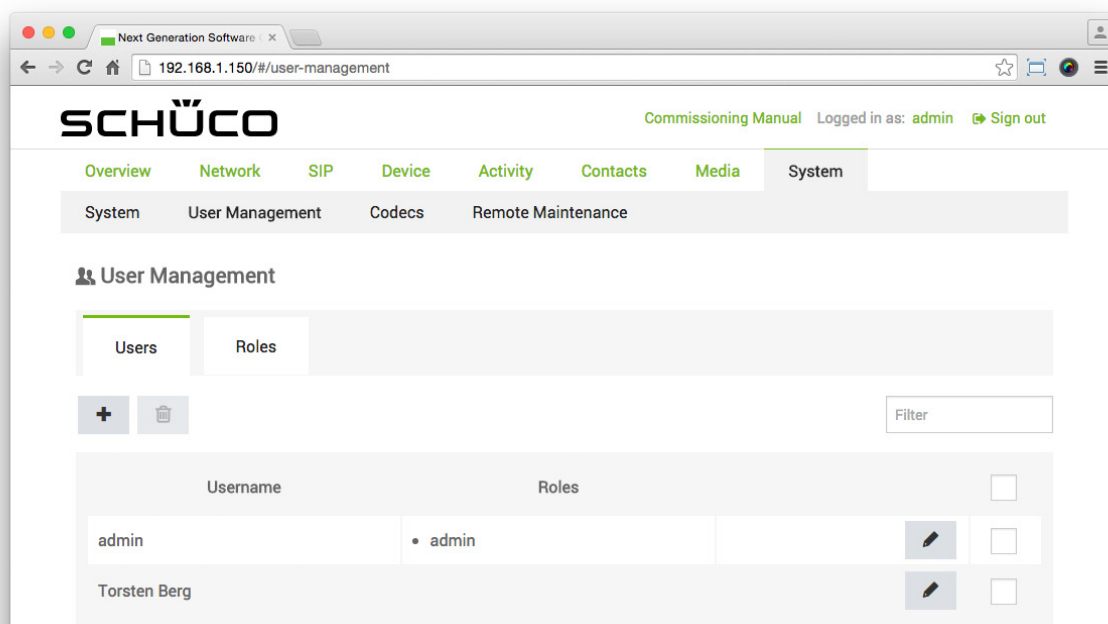

2. Click on .
3. Enter a meaningful user name in the “User name” field.



4. Click on .

5. Click on .
6. Enter the first name and surname of the user in the “First name” and “Surname” fields.
7. Enter the SIP telephone number of the user in the “Address” field.
8. Ensure that the option “English” is selected in the “Language” selection list.
9. Click on  to generate a six-digit access code.
10. Click on .

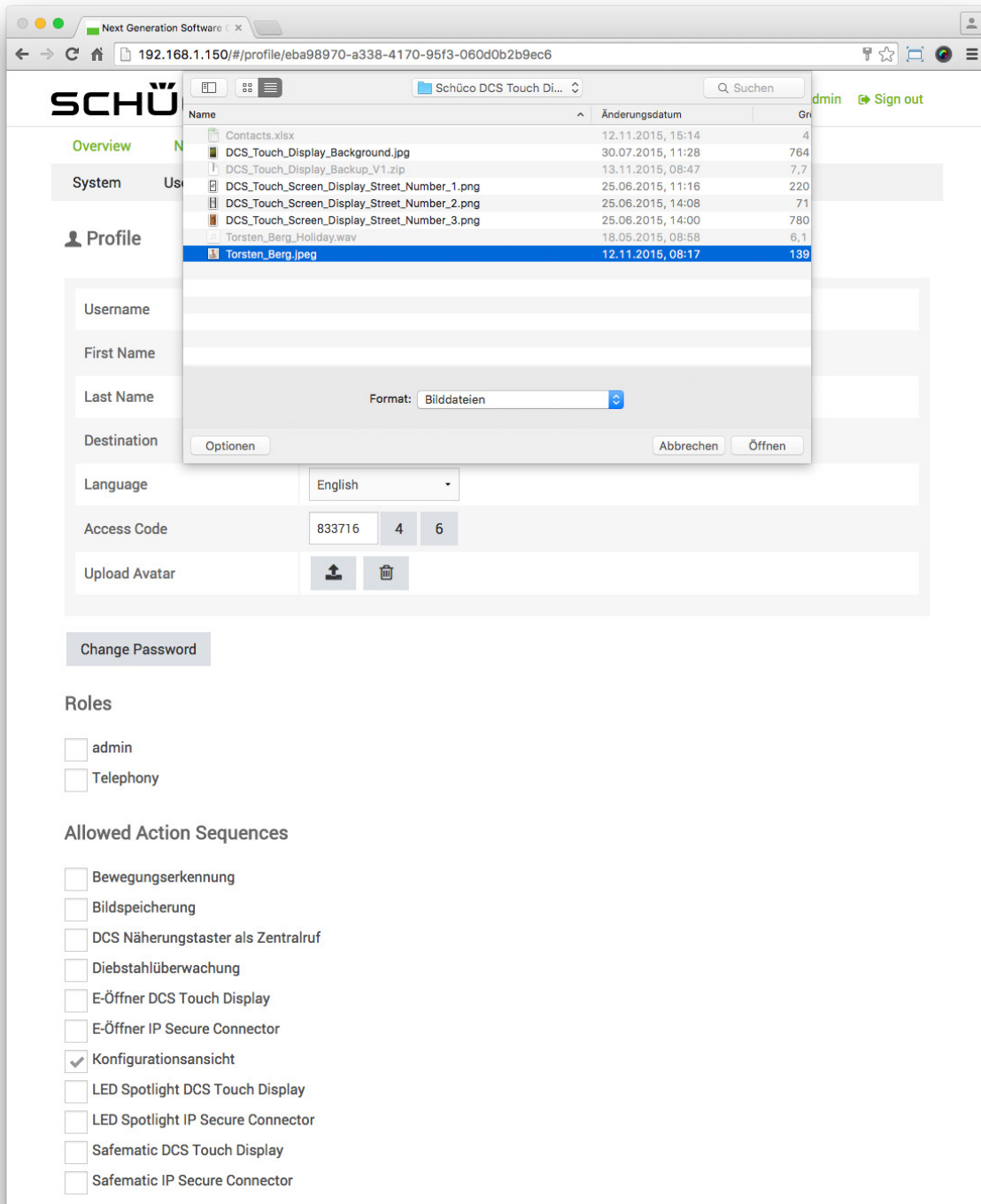

The screenshot displays the user profile management interface for the Schüco DCS Touch Display. The browser window shows the URL `192.168.1.150/#profile/eba98970-a338-4170-95f3-060d0b2b9ec6`. The page features a sidebar with navigation options: Overview, System, and Profile. The Profile section is currently active, showing the following fields and options:

- Username:** (empty field)
- First Name:** (empty field)
- Last Name:** (empty field)
- Destination:** (empty field)
- Language:** English (selected)
- Access Code:** 833716 4 6
- Upload Avatar:** Includes an upload icon and a trash icon.

A modal file selection dialog is open over the Last Name field, displaying a list of files with columns for Name, Änderungsdatum, and Gr. The file `Torsten_Berg.jpeg` is selected.

Below the profile section, there are three main areas:

- Change Password:** A button to change the user's password.
- Roles:** A list of roles with checkboxes:
 - admin
 - Telephony
- Allowed Action Sequences:** A list of action sequences with checkboxes:
 - Bewegungserkennung
 - Bildspeicherung
 - DCS Näherungstaster als Zentralruf
 - Diebstahlüberwachung
 - E-Öffner DCS Touch Display
 - E-Öffner IP Secure Connector
 - Konfigurationsansicht
 - LED Spotlight DCS Touch Display
 - LED Spotlight IP Secure Connector
 - Safematic DCS Touch Display
 - Safematic IP Secure Connector

11. Select the appropriate image for the user and click on “Open”.
12. Check the “Configuration view” checkbox under “Permitted action sequences”.
13. Click on .

9.15.6. Creating a role

The following example will help to explain how a role is created. The aim is to create the new role “Telephony” and assign a user that has already been created.

To create a role, proceed as follows:

1. Via “System”, open the “User administration” page and open the “Roles” view.

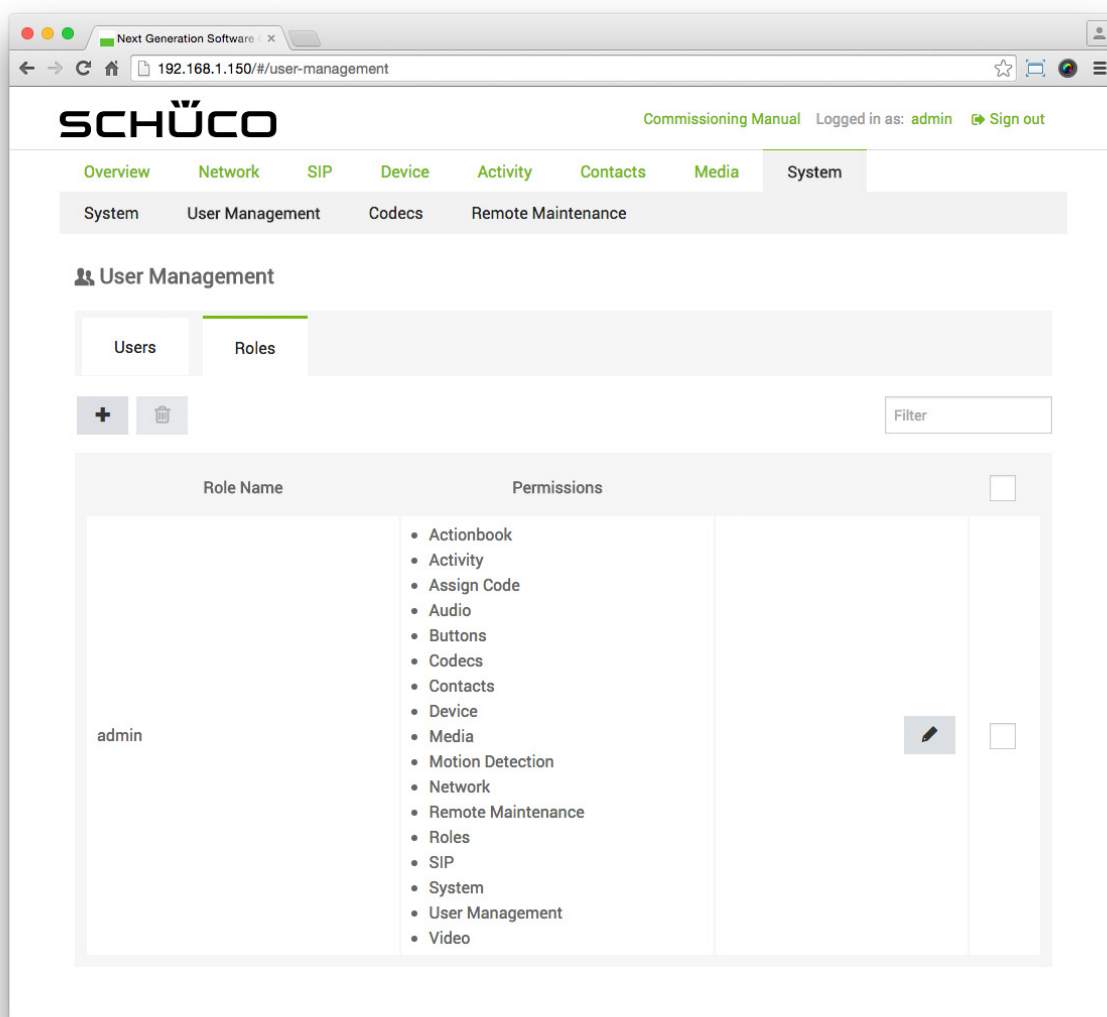

2. Click on .

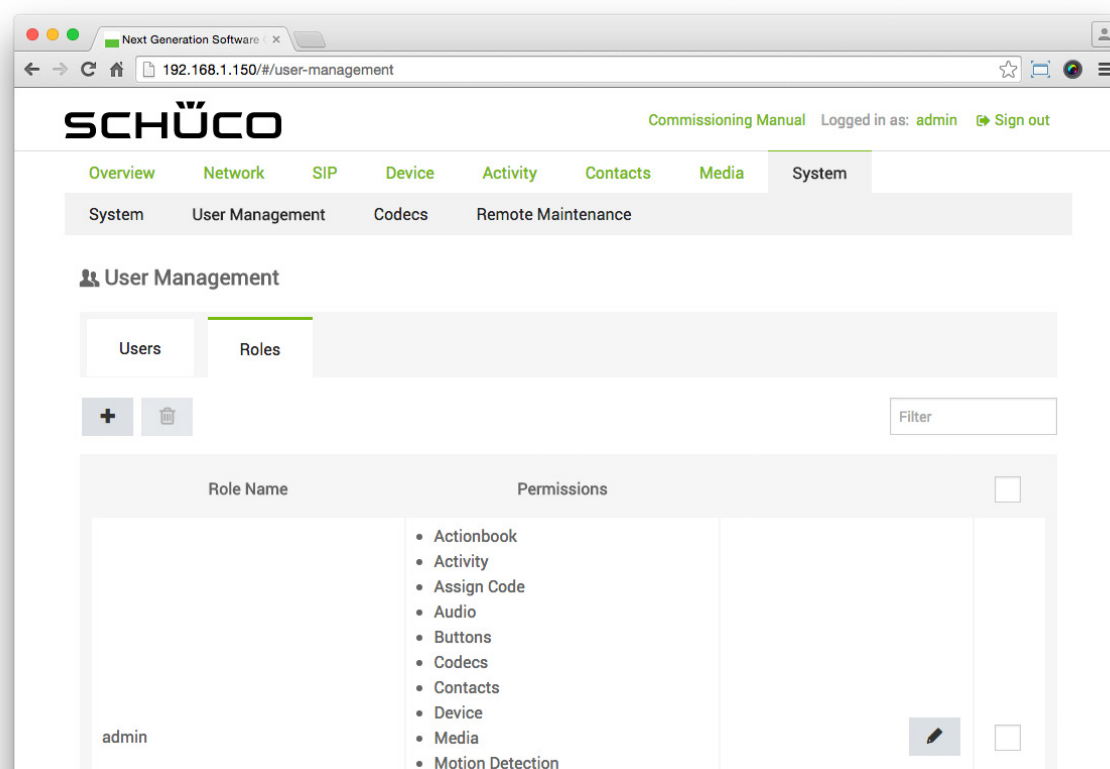

3. In the “Role name” field, enter a meaningful name (e.g. “User”).
4. Check all checkboxes for the pages and functions which are to be assigned to the new role.
5. Click on  .
6. Open the “Users” section.

Next Generation Software x

192.168.1.150/#/profile/c4dc047e-aace-48fa-b94d-2153ac37c58b



SCHÜCO

Commissioning Manual Logged in as: admin Sign out

Overview Network SIP Device Activity Contacts Media System

System User Management Codecs Remote Maintenance

Profile

Username	Torsten Berg
First Name	Torsten
Last Name	Berg
Destination	1234@example.com
Language	English
Access Code	6472 4 6
Upload Avatar	 



Change Password



Roles



- admin
- User

Allowed Action Sequences

- Bewegungserkennung
- Bildspeicherung
- DCS Näherungstaster als Zentralruf
- Diebstahlüberwachung
- E-Öffner DCS Touch Display
- E-Öffner IP Secure Connector
- Konfigurationsansicht
- LED Spotlight DCS Touch Display
- LED Spotlight IP Secure Connector
- Safematic DCS Touch Display
- Safematic IP Secure Connector

 There are unsaved changes in the configuration!

 Save  Discard

7. Click on  next to the appropriate user.
8. Under “Roles” check the checkbox of the role you have just created (e.g. “User”).
9. Click on .

9.15.7. Changing a password

The following example will help to explain how the password for the web interface is changed for a user. The aim is to assign the password “1234567890” to the user “admin”.

Proceed as follows to change the password for a user:

1. Via “System”, open the “User administration” page.

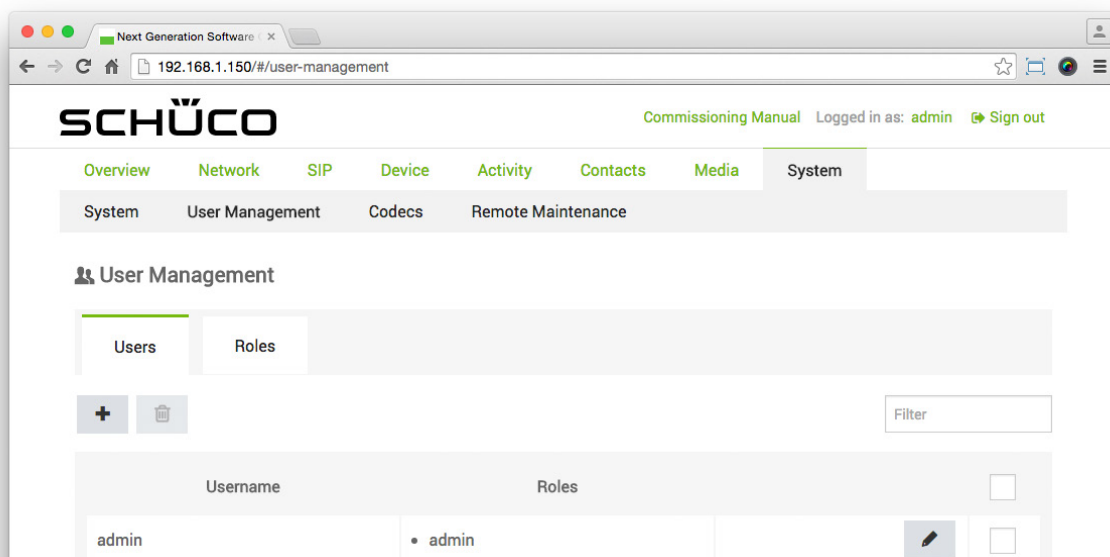

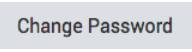
2. Click on  next to the user “admin”.
3. Click on .

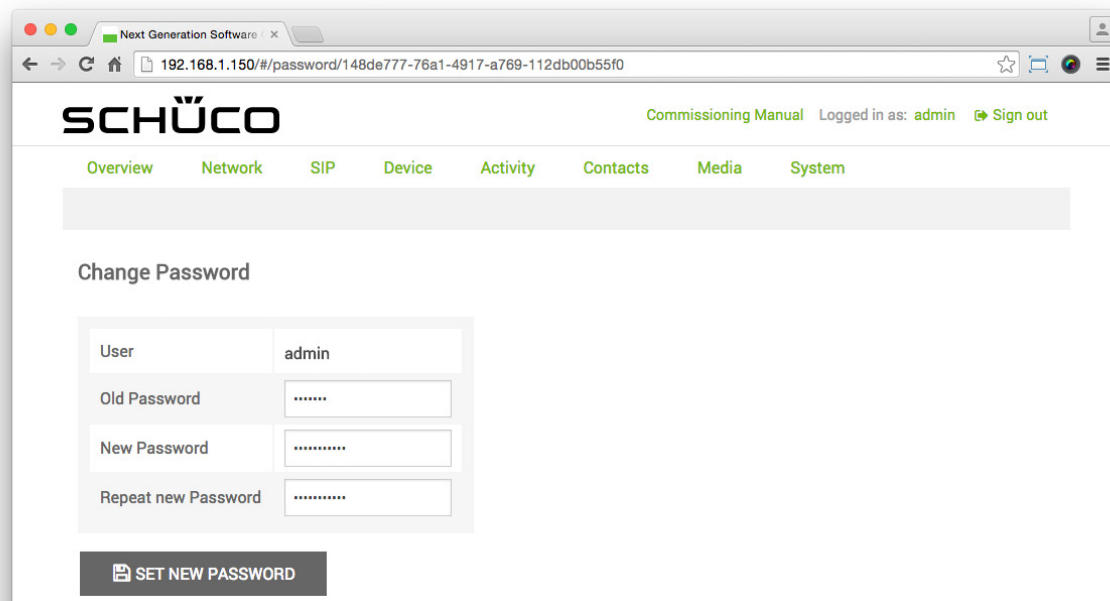

4. Enter the current password in the “Old password” field (“schueco” by default).
5. Enter the new password in the “New password” field and repeat the entry in the “Repeat new password” field (e.g. “0123456789”).
6. Click on .

SCHÜCO Commissioning Manual Logged in as: admin Sign out

Overview Network SIP Device Activity Contacts Media **System**

System User Management Codecs Remote Maintenance

Profile

Username	admin
First Name	
Last Name	
Destination	
Language	English
Access Code	612665 4 6
Upload Avatar	

[Change Password](#)

Roles

- admin
- Telephony

Allowed Action Sequences

- Bewegungserkennung
- Bildspeicherung
- DCS Näherungstaster als Zentralruf
- Diebstahlüberwachung
- E-Öffner DCS Touch Display
- E-Öffner IP Secure Connector
- Konfigurationsansicht
- LED Spotlight DCS Touch Display
- LED Spotlight IP Secure Connector
- Safematic DCS Touch Display
- Safematic IP Secure Connector

There are unsaved changes in the configuration! [Save](#) [Discard](#)

9.15.8. Changing the access code

The following example will help to explain how the access code for the “Code entry” view on the DCS Touch Display is changed for a user. The aim is to assign a six-digit access code to the user “admin”.

Proceed as follows to change the password for a user:

1. Via “System”, open the “User administration” page.
2. Click on  next to the user “admin”.

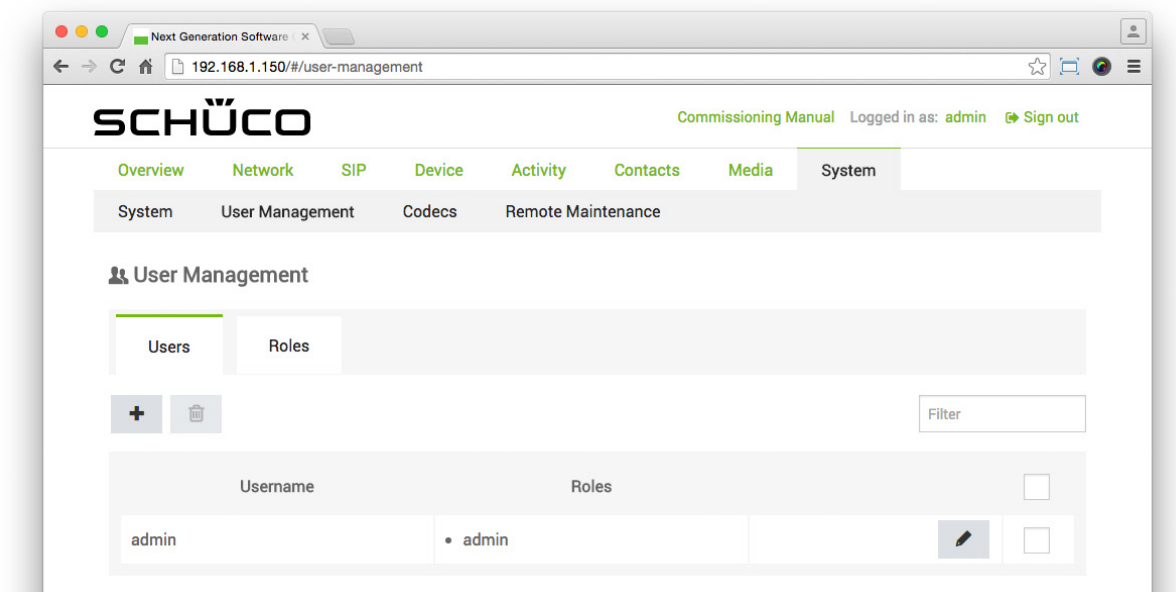

3. Click on  and make a note of the access code that is displayed in the “Access code” field.

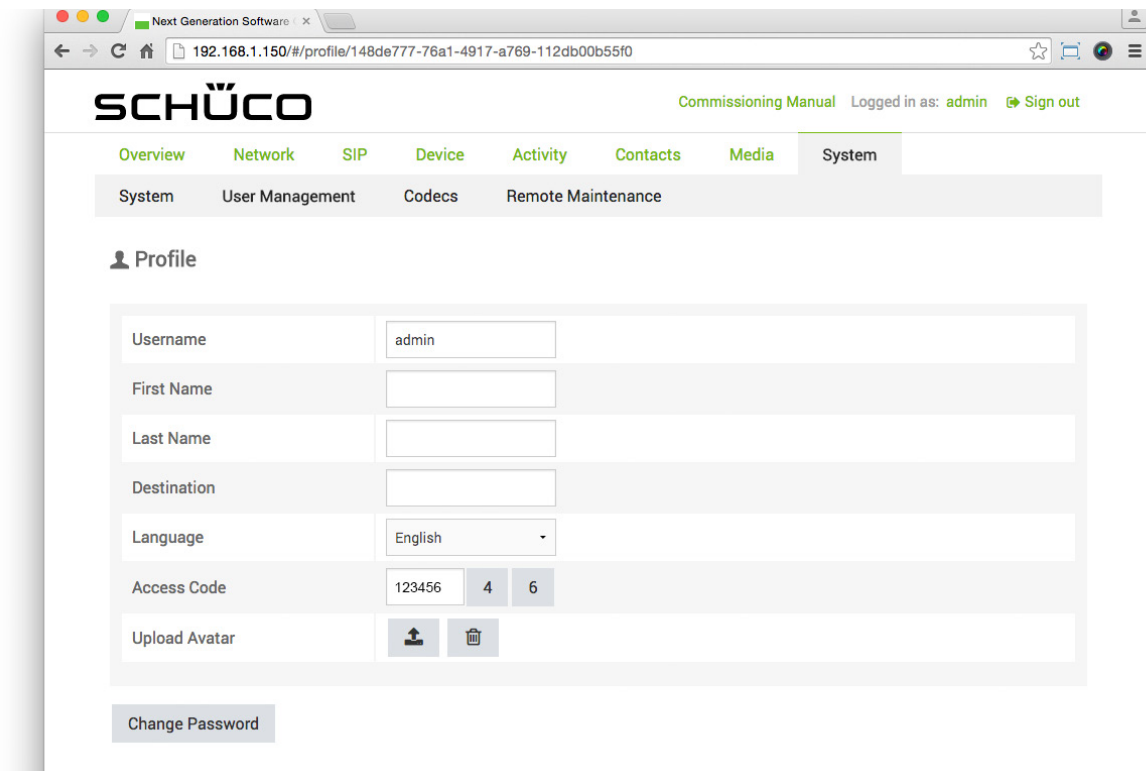
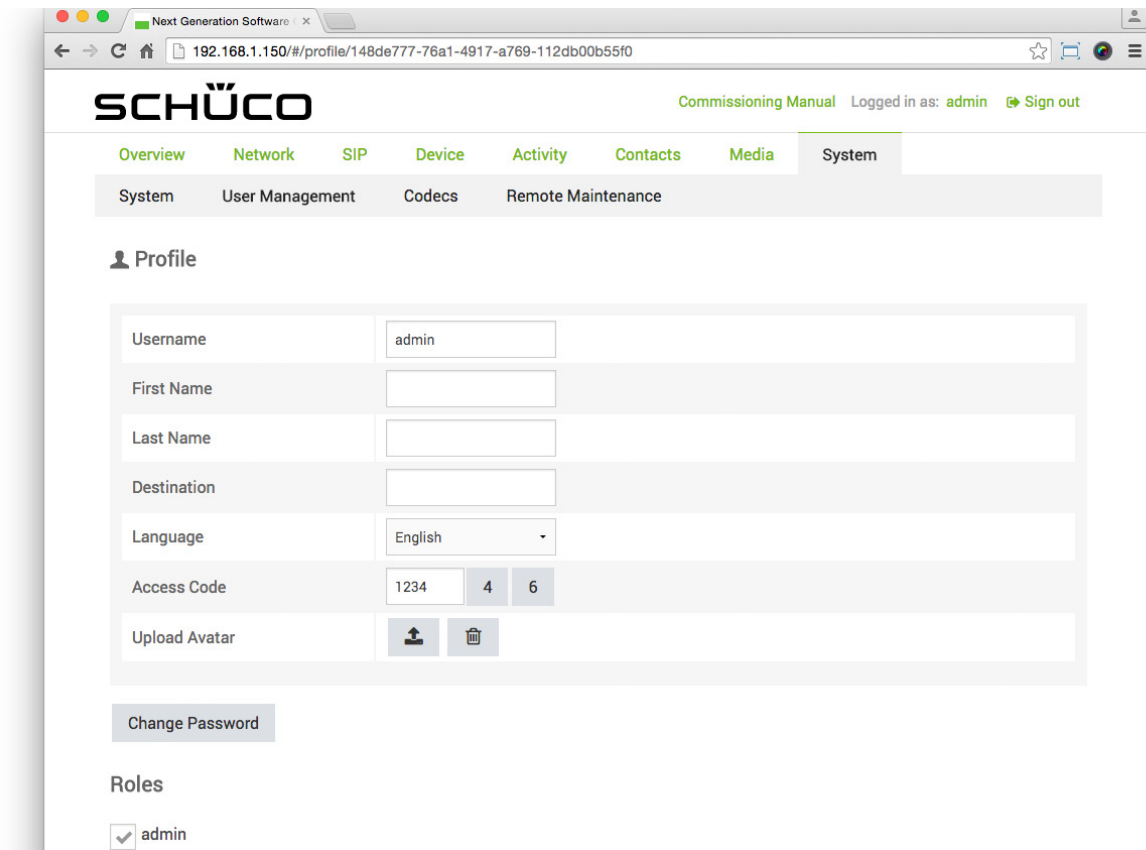

4. Click on  Save.

9.16. Codecs

On the “Codecs” page, it is possible to activate and deactivate available audio and video codecs and define the priority of the formats used.

The following options are available in the “Audio codecs” section:

- G.722: Check this checkbox to compress audio signals in accordance with the standard
- G.722. G.711 a-law: Check this checkbox to compress audio signals in accordance with the standard
- G.711 a-law. G.711 u-law: Check this checkbox to compress audio signals in accordance with the standard G.711 u-law.

The following option is available in the “Video codecs” section:

- H.264: Check this checkbox to compress video signals in accordance with the standard H.264.

Proceed as follows to change the priority of audio codecs:

1. Click on the audio codec for which the priority is to be changed and move it to the desired position.

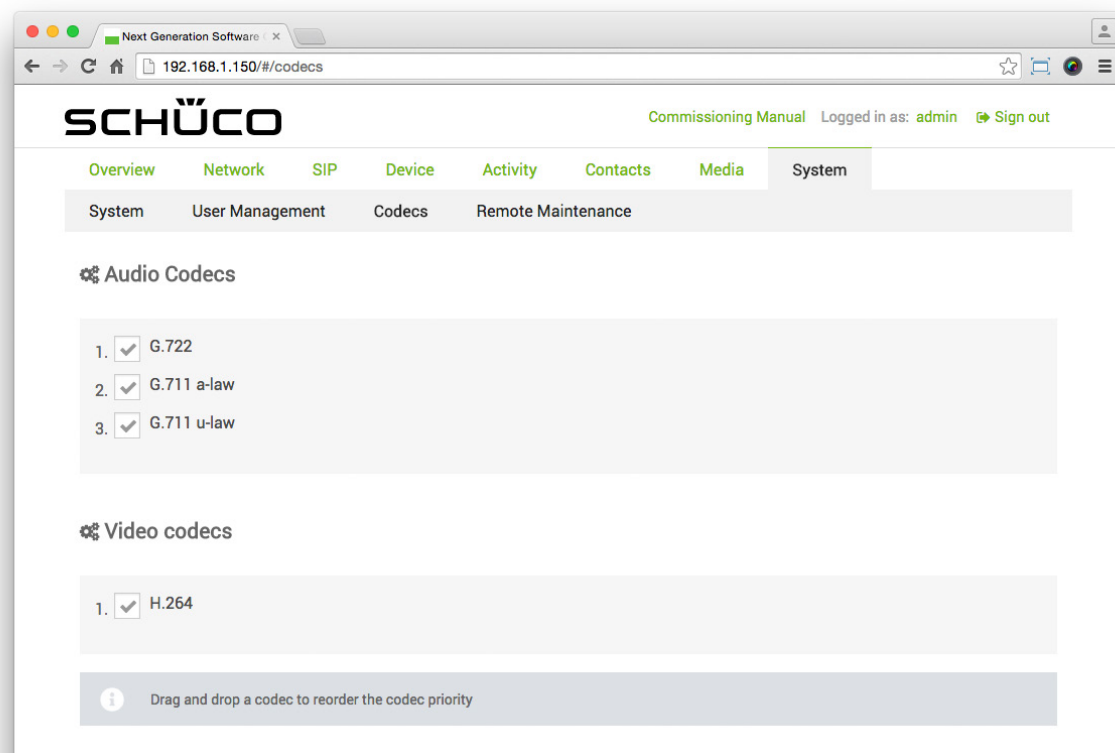

INFORMATION

Priority of codecs

The priority of codecs can be found to the left of the checkbox. Here “1.” has the highest priority and “3.” the lowest.

9.17. Remote maintenance

On the “Remote maintenance” page, it is possible to have remote maintenance carried out on the DCS Touch Display.

The following information is available in the “Network status” section:

Status: Here the status of the remote maintenance is displayed.

Start : Click on this button to start the remote maintenance.

Stop : Click on this button to stop remote maintenance that has been started.

To activate remote maintenance for support purposes, proceed as follows:

1. Tap **Start** .
2. Pass the port numbers displayed on to Support, so that they can connect to the DCS Touch Display.

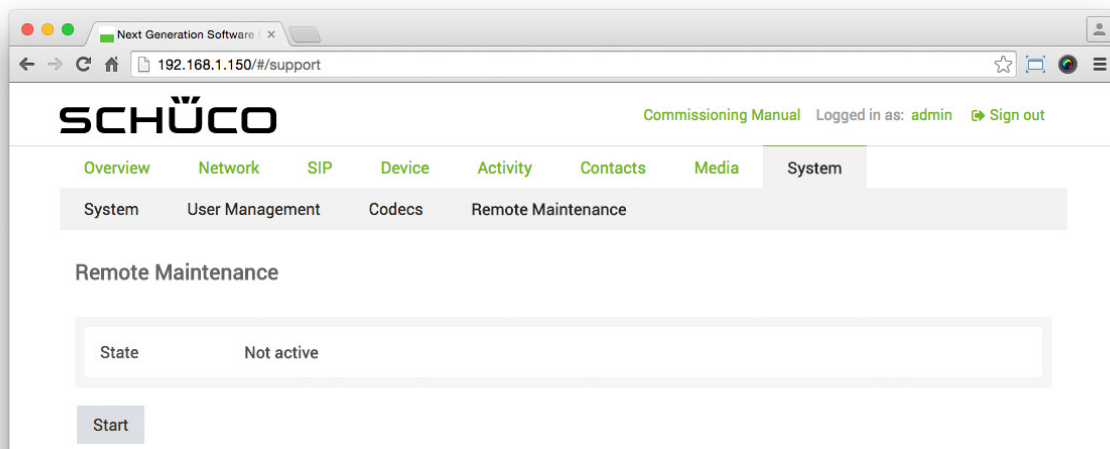

NOTE

Damage to property.

- ▶ Do not stop remote maintenance under any circumstances unless you are told to do so by Support.

10. Replacing an IP secure connector

If an IP secure connector has to be replaced, the connection between the DCS Touch Display and IP secure connector must be disconnected.



INFORMATION

More detailed information

More detailed information about disconnecting the connection between the IP secure connector and DCS Touch Display can be found under “8.4.9 IP secure connector”.

11. Faults and troubleshooting

Fault	Possible cause	Solution
DCS Touch Display is no longer working	The DCS Touch Display has been removed from the DCS unit without the safety release measures.	Place the DCS Touch Display back in the DCS unit and press the „PAIRING“ button on the IP secure connector.

12. Care and maintenance



NOTE

Damage to property

- ▶ Prevent water getting inside the device.
- ▶ Do not use any aggressive or abrasive cleaning agents.
Clean DCS modules using a dry or damp cloth.
Remove more stubborn dirt using a domestic cleaning agent for glass.

13. Decommissioning

The materials used can be recycled. Observe the environmental requirements with regard to recycling, re-use and disposal of operating materials and components in accordance with the local, country-specific and international current technical regulations and official regulations. Make a contribution towards protecting our environment and dispose of the device at a collection point.

14. Service and support

At Schüco, a high level of customer satisfaction is our priority. Should you require further information or encounter problems not dealt with in detail in this document, you can request the requisite information from Building Automation Technical Support.

You can reach your contact partners on the service phone numbers below:

Hotline - Metal systems

Please contact your local branch.

Hotline - Building Automation Technical Support Tel.: +49 (0) 521 - 783 665

Fax: +49 (0) 521 - 783 9071

E-mail: Support_automation@schueco.com

Office hours:

Mon - Thur: 8:00 - 16:30

Fri: 8:00 - 15:00

en Original operating instructions or (and)
translation of original operating instructions

Schüco International KG
Karolinenstraße 1-15
33609 Bielefeld
Tel. +49 521 783-0
Fax +49 521 783-451
www.schueco.de